



I/O RACK

RMio64-D

Owner's Manual

Benutzerhandbuch

Mode d'emploi

Manual de instrucciones

Manual do Proprietário

Manuale di istruzioni

Руководство пользователя

取扱説明書

EN
DE
FR
ES
PT
IT
RU
JA

English

Deutsch

Français

Español

Português

Italiano

Русский

日本語

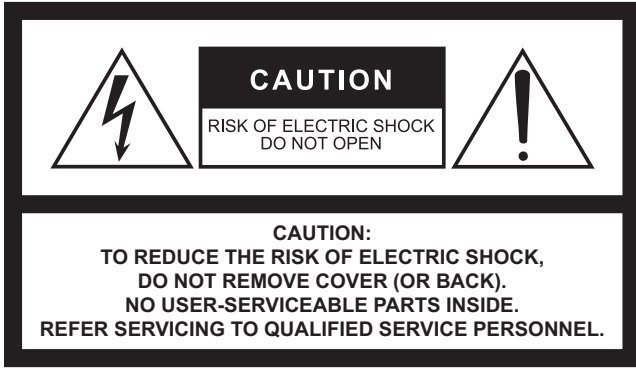

The above warning is located on the top of the unit.



L'avertissement ci-dessus est situé sur le dessus de l'unité.

Explanation of Graphical Symbols Explication des symboles



The lightning flash with arrowhead symbol within an equilateral triangle is intended to alert the user to the presence of uninsulated "dangerous voltage" within the product's enclosure that may be of sufficient magnitude to constitute a risk of electric shock to persons.

L'éclair avec une flèche à l'intérieur d'un triangle équilatéral est destiné à attirer l'attention de l'utilisateur sur la présence d'une « tension dangereuse » non isolée à l'intérieur de l'appareil, pouvant être suffisamment élevée pour constituer un risque d'électrocution.



The exclamation point within an equilateral triangle is intended to alert the user to the presence of important operating and maintenance (servicing) instructions in the literature accompanying the product.

Le point d'exclamation à l'intérieur d'un triangle équilatéral est destiné à attirer l'attention de l'utilisateur sur la présence d'instructions importantes sur l'emploi ou la maintenance (réparation) de l'appareil dans la documentation fournie.

IMPORTANT SAFETY INSTRUCTIONS

- 1 Read these instructions.
- 2 Keep these instructions.
- 3 Heed all warnings.
- 4 Follow all instructions.
- 5 Do not use this apparatus near water.
- 6 Clean only with dry cloth.
- 7 Do not block any ventilation openings. Install in accordance with the manufacturer's instructions.
- 8 Do not install near any heat sources such as radiators, heat registers, stoves, or other apparatus (including amplifiers) that produce heat.
- 9 Do not defeat the safety purpose of the polarized or grounding-type plug. A polarized plug has two blades with one wider than the other. A grounding type plug has two blades and a third grounding prong. The wide blade or the third prong are provided for your safety. If the provided plug does not fit into your outlet, consult an electrician for replacement of the obsolete outlet.
- 10 Protect the power cord from being walked on or pinched particularly at plugs, convenience receptacles, and the point where they exit from the apparatus.
- 11 Only use attachments/accessories specified by the manufacturer.
- 12 Use only with the cart, stand, tripod, bracket, or table specified by the manufacturer, or sold with the apparatus. When a cart is used, use caution when moving the cart/apparatus combination to avoid injury from tip-over.
- 13 Unplug this apparatus during lightning storms or when unused for long periods of time.
- 14 Refer all servicing to qualified service personnel. Servicing is required when the apparatus has been damaged in any way, such as power-supply cord or plug is damaged, liquid has been spilled or objects have fallen into the apparatus, the apparatus has been exposed to rain or moisture, does not operate normally, or has been dropped.



WARNING

TO REDUCE THE RISK OF FIRE OR ELECTRIC SHOCK, DO NOT EXPOSE THIS APPARATUS TO RAIN OR MOISTURE.

(UL60065_03)

PRÉCAUTIONS CONCERNANT LA SÉCURITÉ

- 1 Lire ces instructions.
- 2 Conserver ces instructions.
- 3 Tenir compte de tous les avertissements.
- 4 Suivre toutes les instructions.
- 5 Ne pas utiliser ce produit à proximité d'eau.
- 6 Nettoyer uniquement avec un chiffon propre et sec.
- 7 Ne pas bloquer les orifices de ventilation. Installer l'appareil conformément aux instructions du fabricant.
- 8 Ne pas installer l'appareil à proximité d'une source de chaleur comme un radiateur, une bouche de chaleur, un poêle ou tout autre appareil (y compris un amplificateur) produisant de la chaleur.
- 9 Ne pas modifier le système de sécurité de la fiche polarisée ou de la fiche de terre. Une fiche polarisée dispose de deux broches dont une est plus large que l'autre. Une fiche de terre dispose de deux broches et d'une troisième pour le raccordement à la terre. Cette broche plus large ou cette troisième broche est destinée à assurer la sécurité de l'utilisateur. Si la fiche équipant l'appareil n'est pas compatible avec les prises de courant disponibles, faire remplacer les prises par un électricien.
- 10 Acheminer les cordons d'alimentation de sorte qu'ils ne soient pas piétinés ni coincés, en faisant tout spécialement attention aux fiches, prises de courant et au point de sortie de l'appareil.
- 11 Utiliser exclusivement les fixations et accessoires spécifiés par le fabricant.
- 12 Utiliser exclusivement le chariot, le stand, le trépied, le support ou la table recommandés par le fabricant ou vendus avec cet appareil. Si l'appareil est posé sur un chariot, déplacer le chariot avec précaution pour éviter tout risque de chute et de blessure.
- 13 Débrancher l'appareil en cas d'orage ou lorsqu'il doit rester hors service pendant une période prolongée.
- 14 Confier toute réparation à un personnel qualifié. Faire réparer l'appareil s'il a subi tout dommage, par exemple si la fiche ou le cordon d'alimentation est endommagé, si du liquide a coulé ou des objets sont tombés à l'intérieur de l'appareil, si l'appareil a été exposé à la pluie ou à de l'humidité, si l'appareil ne fonctionne pas normalement ou est tombé.



AVERTISSEMENT

POUR RÉDUIRE LES RISQUES D'INCENDIE OU DE DÉCHARGE ÉLECTRIQUE, N'EXPOSEZ PAS CET APPAREIL À LA PLUIE OU À L'HUMIDITÉ.

(UL60065_03)

FCC INFORMATION (U.S.A.)

1. IMPORTANT NOTICE: DO NOT MODIFY THIS UNIT!

This product, when installed as indicated in the instructions contained in this manual, meets FCC requirements. Modifications not expressly approved by Yamaha may void your authority, granted by the FCC, to use the product.

2. IMPORTANT: When connecting this product to accessories and/or another product use only high quality shielded cables. Cable/s supplied with this product **MUST** be used. Follow all installation instructions. Failure to follow instructions could void your FCC authorization to use this product in the USA.

3. NOTE: This product has been tested and found to comply with the requirements listed in FCC Regulations, Part 15 for Class "B" digital devices. Compliance with these requirements provides a reasonable level of assurance that your use of this product in a residential environment will not result in harmful interference with other electronic devices. This equipment generates/uses radio frequencies and, if not installed and used according to the instructions found in the users manual, may cause interference harmful to the operation of other electronic devices. Compliance with FCC

regulations does not guarantee that interference will not occur in all installations. If this product is found to be the source of interference, which can be determined by turning the unit "OFF" and "ON", please try to eliminate the problem by using one of the following measures:

Relocate either this product or the device that is being affected by the interference.

Utilize power outlets that are on different branch (circuit breaker or fuse) circuits or install AC line filter/s.

In the case of radio or TV interference, relocate/reorient the antenna. If the antenna lead-in is 300 ohm ribbon lead, change the lead-in to co-axial type cable.

If these corrective measures do not produce satisfactory results, please contact the local retailer authorized to distribute this type of product. If you can not locate the appropriate retailer, please contact Yamaha Corporation of America, Electronic Service Division, 6600 Orangethorpe Ave, Buena Park, CA90620

The above statements apply **ONLY** to those products distributed by Yamaha Corporation of America or its subsidiaries.

* This applies only to products distributed by YAMAHA CORPORATION OF AMERICA.

(class B)

COMPLIANCE INFORMATION STATEMENT (DECLARATION OF CONFORMITY PROCEDURE)

Responsible Party : Yamaha Corporation of America
Address : 6600 Orangethorpe Ave., Buena Park, Calif. 90620
Telephone : 714-522-9011
Type of Equipment : Audio Interface
Model Name : RMio64-D

This device complies with Part 15 of the FCC Rules.

Operation is subject to the following two conditions:

- 1) this device may not cause harmful interference, and
- 2) this device must accept any interference received including interference that may cause undesired operation.

See user manual instructions if interference to radio reception is suspected.

이 기기는 가정용 (B 급) 전자파적합기기로서 주로 가정에서 사용하는 것을 목적으로 하며, 모든 지역에서 사용할 수 있습니다.

(class b korea)

* This applies only to products distributed by YAMAHA CORPORATION OF AMERICA.

(FCC DoC)

IMPORTANT NOTICE FOR THE UNITED KINGDOM

Connecting the Plug and Cord

WARNING: THIS APPARATUS MUST BE EARTHED IMPORTANT. The wires in this mains lead are coloured in accordance with the following code:

GREEN-AND-YELLOW : EARTH
BLUE : NEUTRAL
BROWN : LIVE

As the colours of the wires in the mains lead of this apparatus may not correspond with the coloured markings identifying the terminals in your plug proceed as follows:

The wire which is coloured GREEN-and-YELLOW must be connected to the terminal in the plug which is marked by the letter E or by the safety earth symbol  or colored GREEN or GREEN-and-YELLOW.

The wire which is coloured BLUE must be connected to the terminal which is marked with the letter N or coloured BLACK.

The wire which is coloured BROWN must be connected to the terminal which is marked with the letter L or coloured RED.

(3 wires)

In Finland: Laite on liitettävä suojamaadoituskoskettimilla varustettuun pistorasiaan.

In Norway: Apparatet må tilkoples jordet stikkontakt.

In Sweden: Apparatens skall anslutas till jordat uttag.

(class I hokuo)

Contents

Introduction 7

Features	7
Precautions for Rack Mounting.....	7
Firmware Updates.....	7
Conventions in this Manual	7

Controls and Functions 8

Front Panel.....	8
Rear Panel.....	9

Connection 11

About Dante	11
Notes Regarding the Use of Network Switches... 11	
Connecting Dante-compatible Devices.....	11
Connecting MADI-compatible Devices	12
Connecting AC Power.....	13
Power on and off	13
Dante Network Settings and Audio Routing	14
Selecting MADI Input Rate.....	14
Panel Lock	14

Signal Flow 14

Dante to MADI.....	14
MADI to Dante.....	14
MADI Split	14

Word Clock 15

About Word Clock.....	15
Selecting a Word Clock Source.....	15

MADI SRC (Sampling Rate Converter) 15

Setting Examples	15
Displaying the MADI Input and Output Signals... 16	

Remote Control 16

Remote Controllable/Displayable Parameters	16
Control from NUAGE Workgroup Manager.....	16

Direct Monitoring 17

RMio64-D Setup 17

Troubleshooting 17

Updating	17
Routing / Patching.....	18
Remote Control	18
Other Issues	18
Restoring Factory Settings.....	18

Index 19

Specifications (at the end of the book)

Included Accessories

- Owner's Manual
- AC power cord (European model includes two different cords.)

PRECAUTIONS

PLEASE READ CAREFULLY BEFORE PROCEEDING

Please keep this manual in a safe place for future reference.



WARNING

Always follow the basic precautions listed below to avoid the possibility of serious injury or even death from electrical shock, short-circuiting, damages, fire or other hazards. These precautions include, but are not limited to, the following:

Power supply/power cord

- Do not place the power cord near heat sources such as heaters or radiators, and do not excessively bend or otherwise damage the cord, place heavy objects on it, or place it in a position where anyone could walk on, trip over, or roll anything over it.
- Only use the voltage specified as correct for the device. The required voltage is printed on the name plate of the device.
- Use only the supplied power cord/plug.
If you intend to use the device in an area other than in the one you purchased, the included power cord may not be compatible. Please check with your Yamaha dealer.
- Check the electric plug periodically and remove any dirt or dust which may have accumulated on it.
- Be sure to connect to an appropriate outlet with a protective grounding connection. Improper grounding can result in electrical shock, damage to the device(s), or even fire.

Do not open

- This device contains no user-serviceable parts. Do not open the device or attempt to disassemble the internal parts or modify them in any way. If it should appear to be malfunctioning, discontinue use immediately and have it inspected by qualified Yamaha service personnel.

Water warning

- Do not expose the device to rain, use it near water or in damp or wet conditions, or place on it any containers (such as vases, bottles or glasses) containing liquids which might spill into any openings. If any liquid such as water seeps into the device, turn off the power immediately and unplug the power cord from the AC outlet. Then have the device inspected by qualified Yamaha service personnel.
- Never insert or remove an electric plug with wet hands.

Fire warning

- Do not put burning items, such as candles, on the unit. A burning item may fall over and cause a fire.

If you notice any abnormality

- When one of the following problems occur, immediately turn off the power switch and disconnect the electric plug from the outlet. Then have the device inspected by Yamaha service personnel.
 - The power cord or plug becomes frayed or damaged.
 - It emits unusual smells or smoke.
 - Some object has been dropped into the device.
 - There is a sudden loss of sound during use of the device.
- If this device should be dropped or damaged, immediately turn off the power switch, disconnect the electric plug from the outlet, and have the device inspected by qualified Yamaha service personnel.



CAUTION

Always follow the basic precautions listed below to avoid the possibility of physical injury to you or others, or damage to the device or other property. These precautions include, but are not limited to, the following:

Power supply/power cord

- When removing the electric plug from the device or an outlet, always hold the plug itself and not the cord. Pulling by the cord can damage it.
- Remove the electric plug from the outlet when the device is not to be used for extended periods of time, or during electrical storms.

Location

- Do not place the device in an unstable position where it might accidentally fall over.
- Do not block the vents. This device has ventilation holes at the front/rear to prevent the internal temperature from becoming too high. In particular, do not place the device on its side or upside down. Inadequate ventilation can result in overheating, possibly causing damage to the device(s), or even fire.
- Do not place the device in a location where it may come into contact with corrosive gases or salt air. Doing so may result in malfunction.
- Before moving the device, remove all connected cables.
- When setting up the device, make sure that the AC outlet you are using is easily accessible. If some trouble or malfunction occurs, immediately turn off the power switch and disconnect the plug from the outlet. Even when the power switch is turned off, electricity is still flowing to the product at the minimum level. When you are not using the product for a long time, make sure to unplug the power cord from the wall AC outlet.
- If the device is mounted in an EIA standard rack, carefully read the section "Precautions for Rack Mounting" on page 7. Inadequate ventilation can result in overheating, possibly causing damage to the device(s), malfunction, or even fire.

Connections

- Before connecting the device to other devices, turn off the power for all devices. Before turning the power on or off for all devices, set all volume levels to minimum.

Maintenance

- Remove the power plug from the AC outlet when cleaning the device.

Handling caution

- Avoid inserting or dropping foreign objects (paper, plastic, metal, etc.) into any gaps or openings on the device (vents, etc.) If this happens, turn off the power immediately and unplug the power cord from the AC outlet. Then have the device inspected by qualified Yamaha service personnel.
- Do not rest your weight on the device or place heavy objects on it, and avoid use excessive force on the buttons, switches or connectors.

Yamaha cannot be held responsible for damage caused by improper use or modifications to the device, or data that is lost or destroyed.

NOTICE

To avoid the possibility of malfunction/ damage to the product, damage to data, or damage to other property, follow the notices below.

Handling and Maintenance

- Do not use the device in the vicinity of a TV, radio, stereo equipment, mobile phone, or other electric devices. Otherwise, the device, TV, or radio may generate noise.
- Do not expose the device to excessive dust or vibration, or extreme cold or heat (such as in direct sunlight, near a heater, or in a car during the day), in order to prevent the possibility of panel disfiguration, unstable operation, or damage to the internal components.
- Do not place vinyl, plastic or rubber objects on the device, since this might discolor the panel.
- When cleaning the device, use a dry and soft cloth. Do not use paint thinners, solvents, cleaning fluids, or chemical-impregnated wiping cloths.
- Condensation can occur in the device due to rapid, drastic changes in ambient temperature — when the device is moved from one location to another, or air conditioning is turned on or off, for example. Using the device while condensation is present can cause damage. If there is reason to believe that condensation might have occurred, leave the device for several hours without turning on the power until the condensation has completely dried out.
- Always turn the power off when the device is not in use.

Information

About functions/data bundled with the product

- This product uses the Dante module provided by Audinate. The Dante module used in this product can be confirmed in Dante Controller. For more information about the open source licenses used for each Dante module, please visit Audinate's website.
<https://www.audinate.com/software-licensing>

About copyrights

- Copying of the commercially available musical data including but not limited to MIDI data and/or audio data is strictly prohibited except for your personal use.

About this manual

- The illustrations and screens as shown in this manual are for instructional purposes only.
- Windows is a registered trademark of Microsoft® Corporation in the United States and other countries.
- The company names and product names in this manual are the trademarks or registered trademarks of their respective companies.

Information for Users on Collection and Disposal of Old Equipment



This symbol on the products, packaging, and/or accompanying documents means that used electrical and electronic products should not be mixed with general household waste.

For proper treatment, recovery and recycling of old products, please take them to applicable collection points, in accordance with your national legislation and the Directives 2002/96/EC.

By disposing of these products correctly, you will help to save valuable resources and prevent any potential negative effects on human health and the environment which could otherwise arise from inappropriate waste handling.

For more information about collection and recycling of old products, please contact your local municipality, your waste disposal service or the point of sale where you purchased the items.

[For business users in the European Union]

If you wish to discard electrical and electronic equipment, please contact your dealer or supplier for further information.

[Information on Disposal in other Countries outside the European Union]

This symbol is only valid in the European Union. If you wish to discard these items, please contact your local authorities or dealer and ask for the correct method of disposal.

(weee_eu_en_01)

The model number, serial number, power requirements, etc., may be found on or near the name plate, which is at the top of the unit. You should note this serial number in the space provided below and retain this manual as a permanent record of your purchase to aid identification in the event of theft.

Model No.

Serial No.

(rear_en_01)

European Models

Inrush Current based on EN 55103-1:2009
2.0 A (on initial switch-on)
2.0 A (after a supply interruption of 5s)
Conforms to Environments: E1, E2, E3 and E4

Introduction

Thank you for choosing the Yamaha RMio64-D audio interface.

To take full advantage of the superior functions and performance offered by the RMio64-D, and to enjoy years of trouble-free use, be sure to read this owner's manual carefully before operation.

Features

The RMio64-D is a digital interface that lets you transfer up to 64 digital inputs and 64 digital outputs between a Dante network and a MADI-compatible device. By connecting both Dante and MADI, this product can be used for wide variety of applications such as broadcasting, live recording, and post production. In addition, full control of this unit's settings has been achieved through tight integration with Yamaha's Dante compatible devices.

- Supports redundancy for both Dante and MADI, and provides a high level of reliability.
- Sampling rate converter (SRC) in MADI inputs and outputs.
- Signals can be looped back from MADI optical to coaxial, or from coaxial to optical (MADI split).
- Enhanced linkage functionality with Steinberg Nuendo, such as direct monitoring and high-precision clock sync with Nuendo SyncStation.

Precautions for Rack Mounting

This unit is rated for operation at ambient temperatures ranging from 0 to 40 degrees Celsius. When mounting the unit with other RMio unit(s) or other device(s) in an EIA standard equipment rack, internal temperatures can exceed the specified upper limit, resulting in impaired performance or failure. When rack mounting the unit, always observe the following requirements to avoid heat buildup:

- When mounting the unit in a rack with devices such as power amplifiers that generate a significant amount of heat, leave more than 1U of space between the RMio and other equipment. Also either leave the open spaces uncovered or install appropriate ventilating panels to minimize the possibility of heat buildup.
- To ensure sufficient airflow, leave the rear of the rack open and position it at least 10 centimeters from walls or other surfaces. If you've installed a fan kit, there may be cases in which closing the rear of the rack will produce a greater cooling effect. Refer to the rack and/or fan unit manual for details.

Firmware Updates

This product enables you to update the unit firmware to improve operations, add functions, and correct possible malfunctions. The following two types of firmware are available for the unit:

- Unit's firmware
- Dante module firmware

You must update each type of firmware separately. Details on updating the firmware are available on the following website:

<http://www.yamahaproaudio.com/>

For information on updating the unit, refer to the firmware update guide available on the website.

NOTE

It is necessary to update multiple devices depending on the version of each device in the Dante network. For details, refer to the firmware compatibility available on the website.

<http://www.yamahaproaudio.com/>

Conventions in this Manual

Screen Shots

The example screen shots shown in this manual are from the Windows version, while those for Steinberg Nuendo are from Nuendo 6.5. Therefore, the actual displays might appear different if you are using a different version of Nuendo. For details, see the Owner's Manual (PDF) from the "Help" menu in Nuendo.

Controls and Functions

Front Panel

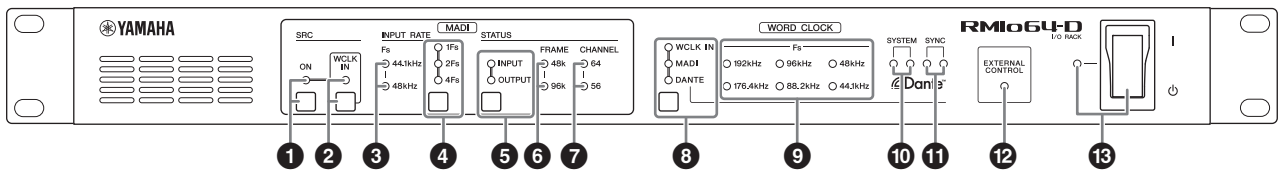

1 MADI [SRC ON] indicator MADI [SRC ON] key

Turns the MADI SRC (Sampling Rate Converter) on (indicator lights) and off.

2 MADI [SRC WCLK IN] indicator MADI [SRC WCLK IN] key

Selects whether the word clock that is input to the MADI [WCLK IN FOR SRC] connector on the rear panel is used or not as the reference MADI SRC clock. (Indicator lights when used.)

If no valid word clock input is detected, this indicator flashes.

3 MADI [INPUT RATE Fs 44.1kHz] indicator MADI [INPUT RATE Fs 48kHz] indicator

These indicators turn on accordingly when the device automatically detects the MADI input signal as 44.1 kHz or 48 kHz. If no valid MADI input signal is detected, both indicators remain off.

4 MADI [INPUT RATE 1Fs] indicator MADI [INPUT RATE 2Fs] indicator MADI [INPUT RATE 4Fs] indicator MADI [INPUT RATE] 1Fs/2Fs/4Fs key

Selects 1Fs (1x), 2Fs (2x), or 4Fs (4x) in combination with the MADI input rate. For example, for a MADI input rate of 192 kHz (4x 48 kHz), confirm that the MADI [INPUT RATE Fs 48kHz] indicator is on, and then select [4Fs].

NOTE

If you select [2Fs], the unit automatically detects the MADI input signal frame format (48 kHz/96 kHz).

5 MADI [STATUS INPUT] indicator MADI [STATUS OUTPUT] indicator MADI [STATUS] INPUT/OUTPUT key

Selects whether to display the MADI input signal or MADI output signal information (frame format/ number of channels).

NOTE

You can use this key to lock the panel to prevent operation of the keys (page 14).

6 MADI [STATUS FRAME 48k] indicator MADI [STATUS FRAME 96k] indicator

Displays the frame format of the MADI input signal or output signal. For 44.1 kHz and 48 kHz, the [STATUS FRAME 48k] indicator is lit. For 88.2 kHz and 96 kHz, the [STATUS FRAME 96k] indicator is lit. If no valid MADI input signal is detected, both indicators remain off.

NOTE

If no valid MADI input signal is detected, the MADI output signal is set to 48 kHz/64 channels.

7 MADI [STATUS CHANNEL 64] indicator MADI [STATUS CHANNEL 56] indicator

Displays the number of channels (64 or 56) for the MADI input signal or output signal. If no valid MADI input signal is detected, both indicators remain off.

NOTE

If no valid MADI input signal is detected, the MADI output signal is set to 48 kHz/64 channels.

8 WORD CLOCK [WCLK IN] indicator WORD CLOCK [MADI] indicator WORD CLOCK [DANTE] indicator WORD CLOCK WCLK IN/MADI/DANTE key

Selects the word clock source.

WCLK IN	Uses the word clock signal that is input from the [WORD CLOCK IN] connector on the rear panel. This indicator flashes if no valid word clock input is detected.
MADI	Uses the word clock of the MADI input signal. This indicator flashes if no valid word clock input is detected.
DANTE	Uses the word clock from the Dante network.

9 WORD CLOCK [Fs] indicator

Displays the word clock frequency that the unit is using. This indicator flashes if no word clock is synced.

10 Dante [SYSTEM] indicator

Displays the operating status of the unit.

Green (indicator lights)	The unit is working properly.
Green (indicator flashes)	The firmware updating is in progress.
Red (indicator lights)	The memory on the unit does not work properly.
Red (indicator flashes)	An error has occurred in the Dante module.

11 Dante [SYNC] indicator

Displays the sync status between the Dante network and this unit.

Green (indicator lights)	The device is working as the follower on the Dante network.
Green (indicator flashes)	The device is working as the leader on the Dante network.

Orange (indicator lights)	Synchronization with the Dante network is in progress.
Orange (indicator flashes)	The device is not synchronized with the Dante network.

12 [EXTERNAL CONTROL] indicator

This indicator turns on when a parameter which can be operated only from an external remote control is effective.

For details about parameters that can be operated by remote control, see “Remote Control” (page 16).

13 Power indicator [I]/[O] (Power Switch)

Turns power of the unit to on [I] or off [O].

The indicator turns on when AC power is on.

⚠ CAUTION

Even when the power switch is turned off, a small amount of current is flowing through the unit. When you are not using the product for a long time, make sure to unplug the power cord from the AC outlet.

NOTE

Rapidly turning the unit on and off in succession can cause it to malfunction. After turning the unit off, wait for at least 6 seconds before turning it on again.

Rear Panel

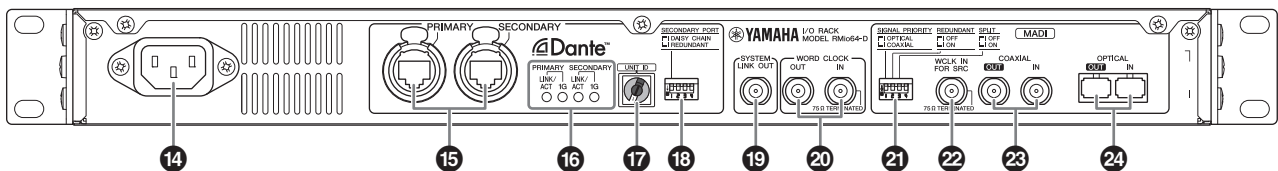

14 AC IN connector

Connect the supplied AC power cord here. First connect the AC power cord to the RMio unit, then insert the power cord plug into an AC power outlet. The supplied AC power cord features a V-lock mechanism via a latch, which prevents the power cord from coming off accidentally. Insert the cable plug all the way until it locks in securely.

⚠ CAUTION

Be sure to turn the power off before connecting or disconnecting the power cord.

Press the latch button on the plug to disconnect the power cord.

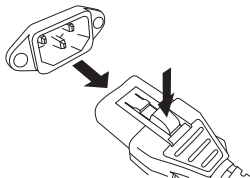

15 Dante [PRIMARY] connector Dante [SECONDARY] connector

These are etherCON (RJ-45) connectors for connecting to the Dante network.

NOTE

- Use STP (Shielded Twisted Pair) cable to prevent electromagnetic interference. Make sure that the metal parts of the plugs are electrically connected to the STP cable shield by conductive tape or comparable means.
- Connect only Dante-compatible devices or GbE-compatible devices (including a computer).
- Cables of up to 100 meters (theoretical value) can be used.

16 Dante [PRIMARY LINK/ACT] indicator
Dante [PRIMARY 1G] indicator
Dante [SECONDARY LINK/ACT] indicator
Dante [SECONDARY 1G] indicator

Displays the transmission status with the Dante network.

LINK/ACT	These indicators flash rapidly if the Ethernet cables are connected properly.
1G	These indicators are lit when the Dante network is functioning as Giga-bit Ethernet.

17 Dante [UNIT ID] rotary switch

Sets the ID for this unit. The setting range of the UNIT ID is 16 hexadecimal numbers from 0 to F. If there are multiple Dante-compatible devices from Yamaha that require an ID setting connected to the same network, set a different ID for each device. Make sure to change the settings of the rotary switch while the power to the unit is turned off; otherwise, the ID setting will not be effective.

18 Dante DIP switches

Used to change unit settings. Make sure to change the settings of the DIP switches while the power to the unit is turned off; otherwise, the ID setting will not be effective. For details, see “Connecting Dante-compatible Devices” (page 11) and “Restoring Factory Settings” (page 18).

19 [SYSTEM LINK OUT] connector

This BNC connector is used to connect to the AES 2 IN connector on the Steinberg Nuendo SyncStation. This connection provides a highly precise clock sync between this unit and Nuendo.

When not connecting with Nuendo SyncStation, two of the channels for the Dante input signals are output as AES/EBU signals. Connecting the AES/EBU-compatible devices to this connector allows Dante signals to be converted to AES/EBU signals and can be output. In the default settings, Dante channels 1 and 2 are used for output. You can use a remote control to change the output channels. For details, see “Remote Control” (page 16).

20 [WORD CLOCK OUT] connector
[WORD CLOCK IN] connector

These are BNC connectors used to transmit and receive word clock signals.

21 MADI DIP switches

Used to change unit settings. Make sure to change the settings of the DIP switches while the power to the unit is turned off; otherwise, the ID setting will not be effective. For details, see “Connecting MADI-compatible Devices” (page 12) and “MADI Split” (page 14).

22 MADI [WCLK IN FOR SRC] connector

This is a BNC connector that can be used to directly input word clock signals for MADI SRC.

23 MADI [COAXIAL OUT] connector
MADI [COAXIAL IN] connector

These are BNC connectors used to connect with MADI-compatible devices.

NOTE

Coaxial cables of up to 100 meters (theoretical value) can be used.

24 MADI [OPTICAL OUT] connector
MADI [OPTICAL IN] connector

These are SC connectors used to connect with MADI-compatible devices.

NOTE

- Use a multimode optical cable with 50-micron core/125-micron cladding diameters, or 62.5-micron core/125-micron cladding diameters.
- Optical cables of up to 2,000 meters (theoretical value) can be used.
- Use SC duplex connectors.
- Attach the supplied rubber cap to the connector to prevent dust from collecting when the cable is not connected.

Connection

This section describes the following connections.

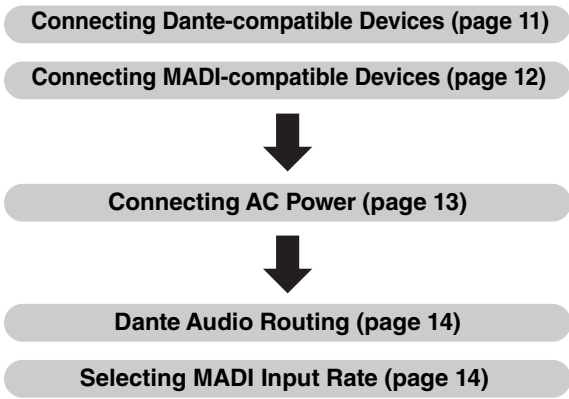

About Dante

Dante is a network audio protocol developed by Audinate. It is designed to deliver multi-channel audio signals at various sampling and bit rates, as well as device control signals over a Giga-bit Ethernet (GbE) network.

Visit the Audinate website for more details on Dante:
<http://www.audinate.com/>

More information on Dante is also posted on the Yamaha Pro Audio website:
<http://www.yamahaproaudio.com/>

Notes Regarding the Use of Network Switches

Do not use the EEE functionality (*) of network switches on a Dante network.

Although mutual power consumption settings between switches that support the EEE functionality are adjusted automatically, there are some switches for which such mutual settings are not adjusted correctly.

This may cause EEE to be enabled in Dante networks when it is not appropriate, resulting in poor synchronization performance and occasional dropouts. Therefore we strongly recommend the following.

- If you use managed switches, please disable the EEE functionality. Do not use switches that prevent EEE functionality from being disabled.
- When using unmanaged switches, do not use switches that support EEE functionality. EEE functionality cannot be disabled for such switches.

* EEE (Energy Efficient Ethernet) is a technology that reduces switch power consumption during periods of low network traffic. It is also referred to as Green Ethernet and IEEE802.3az.

Connecting Dante-compatible Devices

You can connect the RMio64-D to a Dante network in the following ways.

Daisy Chain Network

A daisy chain network is a wiring scheme in which multiple devices are connected together in sequence. This connection method is suitable for a simple system with a small number of devices. However, if a large number of devices are connected, you will also need to manually increase the latency value significantly. Also, if a connection is broken in a daisy chain network, the signal flow is interrupted at that point and no signal will be transferred beyond that point.

■ Settings

- Turn off Dante DIP switch 1 (UP).
- If there are multiple Dante-compatible devices from Yamaha that require an ID setting connected to the same network, set a different ID for each device. Make sure to change the settings of the rotary switch while the power to the unit is turned off; otherwise, the ID setting will not be effective.

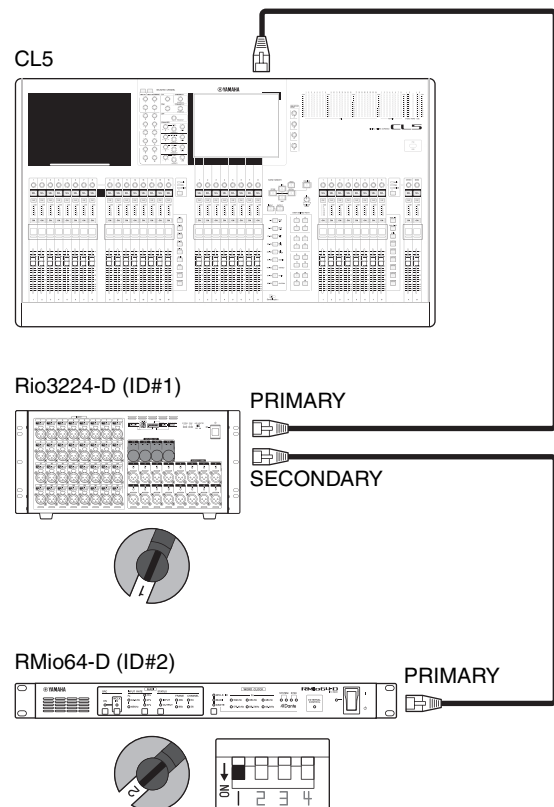

Star Network

In a star network, each device is connected to a central GbE-compatible network switch. This connection enables you to configure a wide-band, large-scale network.

Settings

- Turn on Dante DIP switch 1 (DOWN).
- If there are multiple Dante-compatible devices from Yamaha that require an ID setting connected to the same network, set a different ID for each device. Make sure to change the settings of the rotary switch while the power to the unit is turned off; otherwise, the ID setting will not be effective.

NOTE

- We recommend a network switch that features various functions for controlling and monitoring the network (such as QoS).
- Do not use the EEE functionality of network switches.

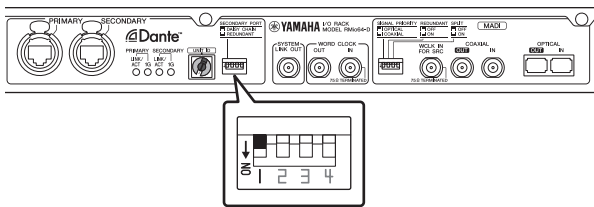

Star Network (Redundant Network)



You can set up a star network redundant so that there is no audio loss even if interference occurs on the network. A redundant network consists of two circuits, a primary circuit and a secondary circuit. Normally, the network operates on the primary circuit. However, if the primary connection is broken, the secondary circuit will automatically take over communications.

Settings

- Turn on Dante DIP switch 1 (DOWN).
- If there are multiple Dante-compatible devices from Yamaha that require an ID setting connected to the same network, set a different ID for each device. Make sure to change the settings of the rotary switch while the power to the unit is turned off; otherwise, the ID setting will not be effective.

NOTE

- We recommend a network switch that features various functions for controlling and monitoring the network (such as QoS).
- Do not use the EEE functionality of network switches.
- The Dante [SYNC] indicator flashes as follows when communication error occurs on the Dante Redundant Network.

Error on a primary network	Error on a secondary network
<p>Light or flash (green)  Flashes once (orange)</p>	<p>Light or flash (green)  Flashes twice (orange)</p>

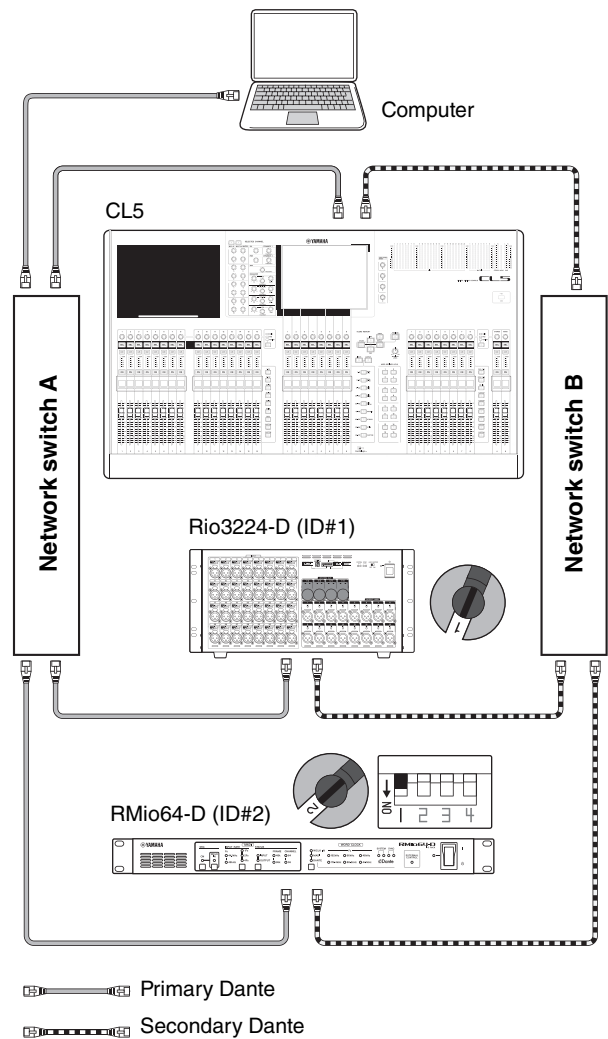

Connecting MADi-compatible Devices

You can connect the RMio64-D to MADi-compatible devices using either 75Ω coaxial (BNC) or optical (SC) cables.

Using 75Ω Coaxial Cables

NOTE

Coaxial cables of up to 100 meters (theoretical value) can be used.

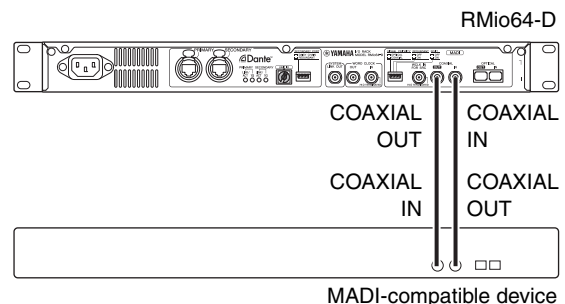

Using Optical Cables

NOTE

Optical cables of up to 2,000 meters (theoretical value) can be used.

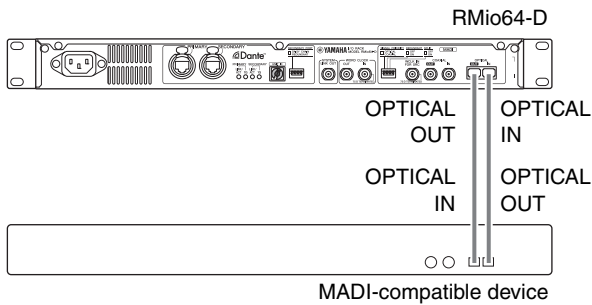

Redundant Connection (Input only)

You can set up a redundant connection using both 75Ω coaxial cables and optical cables, so that there is no input signal loss even if interference occurs in the connection.

In addition, the input signal from the Dante network is output from both the MADI [COAXIAL OUT] and MADI [OPTICAL OUT] connectors, regardless of the MADI redundancy settings.

■ Settings

- To set up a redundant connection, turn on MADI DIP switch 2 (DOWN).
- To give priority to the coaxial cables, turn on MADI DIP switch 1 (DOWN).
- To give priority to the optical cables, turn off MADI DIP switch 1 (UP).

NOTE

Make sure to change the settings of the DIP switches while the power to the unit is turned off; otherwise, the ID setting will not be effective.

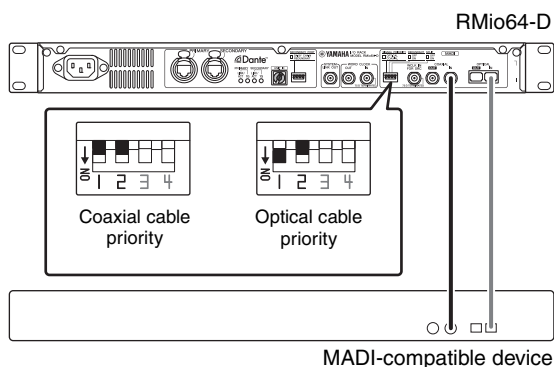

When using the word clock input from the MADI [WCLK IN FOR SRC] connector as the MADI SRC reference clock, the redundant function is unavailable.

Connecting AC Power

1. Turn the unit off.
2. Connect the plug on the AC power cord to the AC IN connector on the rear panel of the unit.
3. Connect the other side of the plug on the AC power cord to a power supply socket.

NOTE

- When removing the AC power cord, perform these steps in reverse.
- Press the latch button on the plug to disconnect the power cord.

⚠ WARNING

- The RMio64-D has been designed assuming it a proper ground connection is used. To prevent electrical shock and damage to devices, use the included AC power cord to create a secure ground connection. If you do not know how to make a proper ground connection, contact a Yamaha service center listed at the end of this manual.
- Be sure to use only the included power cord with this unit. Use of a different power cord could result in abnormal heat and electrical shock.

⚠ CAUTION

- Be sure to turn the power off before connecting or disconnecting the power cord.
- Even when the power switch is turned off, a small amount of current is flowing through the unit. When you are not using the product for a long time, make sure to unplug the power cord from the power supply outlet.

Power on and off

When turning on the AC power in your audio system, always turn on the power amplifier LAST, to avoid speaker damage. When turning the power off, the power amplifier should be turned off FIRST for the same reason.

Dante Network Settings and Audio Routing

With the Dante network, you can route the audio input and output of multiple Dante devices in any way you like. This requires you to set which channel signals are sent to which inputs. The routing for connecting MADI with the Dante network is fixed on the RMio64-D. Therefore, any changes in routing are made in the Dante network. Use Dante Controller to configure the audio routing of the Dante network.

You can download Dante Controller from the following website:
<http://www.yamahaproaudio.com/>

Refer to the Dante Controller owner's manual (available from the same website) for details about Dante Controller.

Selecting MADI Input Rate

Use the MADI [INPUT RATE] 1Fs/2Fs/4Fs keys on the front panel to select the MADI input rate. For example, for a MADI input rate of 192 kHz (4x 48 kHz), confirm that the MADI [INPUT RATE Fs 48kHz] indicator is on, and then select [4Fs]. If no valid MADI input signal is detected, both indicators remain off.

Panel Lock

You can lock the panel to prevent unintended changes and operations. While the lock is engaged, all controllers on the front panel are inoperable. To engage the lock, press and hold the MADI [STATUS] INPUT/OUTPUT key for at least 3 seconds. All front panel indicators (except the power indicator) flash, indicating all controllers are locked. To disengage the lock, press and hold the MADI [STATUS] INPUT/OUTPUT key for at least 3 seconds.

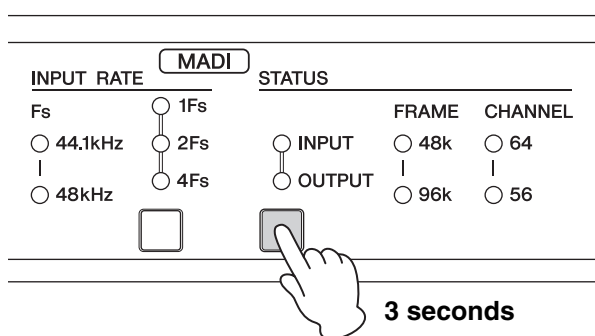

NOTE

Even if the front panel is locked, you can use remote control to make changes to the settings. For the latest information about remote control compatible devices, refer to the Yamaha Pro Audio website:
<http://www.yamahaproaudio.com/>

Signal Flow

Dante to MADI

The Dante input signal is output from the MADI [COAXIAL OUT] connector and the [OPTICAL OUT] connector.

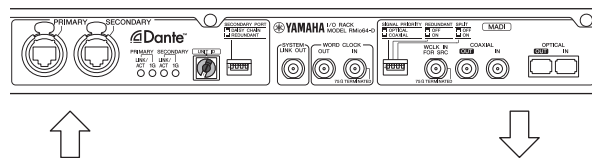

MADI to Dante

The MADI input signal is output from the Dante [PRIMARY] and [SECONDARY] connectors.

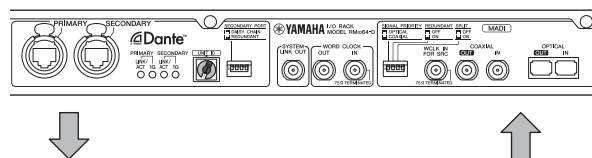

MADI Split

A signal that is input via coaxial or optical connector can be looped back via the other connector. When doing so, the signal also goes to the Dante network.

■ Settings

- To use a MADI split, turn on MADI DIP switch 3 (DOWN).
- To loop back the input signal from the MADI [COAXIAL IN] connector to the MADI [OPTICAL OUT] connector, turn on MADI DIP switch 1 (DOWN).

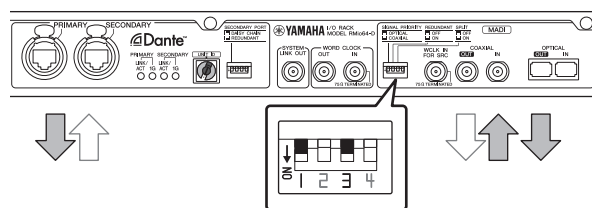

- To loop back the input signal from the MADI [OPTICAL IN] connector to the MADI [COAXIAL OUT] connector, turn off MADI DIP switch 1 (UP).

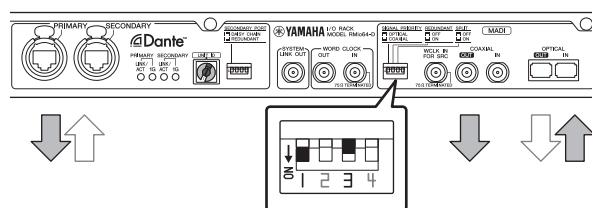

NOTE

Make sure to change the settings of the DIP switches while the power to the unit is turned off; otherwise, the ID setting will not be effective.

Word Clock

About Word Clock

- You can set the word clock source to an external clock device, the MADI input signal, or the Dante network.
- You can send the word clock from this unit to an external device via the [WORD CLOCK OUT] connector.
- You can connect the [SYSTEM LINK OUT] connector to the AES 2 IN connector on Steinberg Nuendo SyncStation for high-precision clock sync with Nuendo.

Selecting a Word Clock Source

Use the WORD CLOCK [WCLK IN]/[MADI]/[DANTE] key on the front panel to select the word clock source. The unit's clock is synced with the selected word clock source.

WCLK IN	Uses the word clock signal that is input from the [WORD CLOCK IN] connector on the rear panel. This indicator flashes if no valid word clock input is detected.
MADI	Uses the word clock of the MADI input signal. This indicator flashes if no valid word clock input is detected.
DANTE	Uses the word clock from the Dante network.

NOTE

- If you select [WCLK IN] or [MADI], the unit is automatically specified as the "Preferred Leader" and "Enable Sync To External" is set in the Dante network.
- If you select [WCLK IN] or [MADI], when the unit acts as the clock follower on the Dante network, input to the unit the same clock as the clock leader. You can use Dante Controller (available from the following website) to check which device is the current clock leader.
<http://www.yamahaproaudio.com/>
- If the word clock signal from the selected work clock source is cut off, the unit switches to its internal clock. The internal clock operates according to the previous word clock, before it was cut off.

MADI SRC (Sampling Rate Converter)

MADI SRC allows you to connect a MADI-compatible device having a different clock than the RMio64-D unit.

- You can connect a Dante network and a MADI-compatible device that are operating under different clocks without making any changes to either clock.
- You can output MADI signals with a different word clock than the MADI input signal.

Setting Examples

NOTE

Output Clock Source in the following block diagram can be controlled only by remote control.

Using the MADI signal internal clock on the MADI side, and syncing the unit to the Dante network:

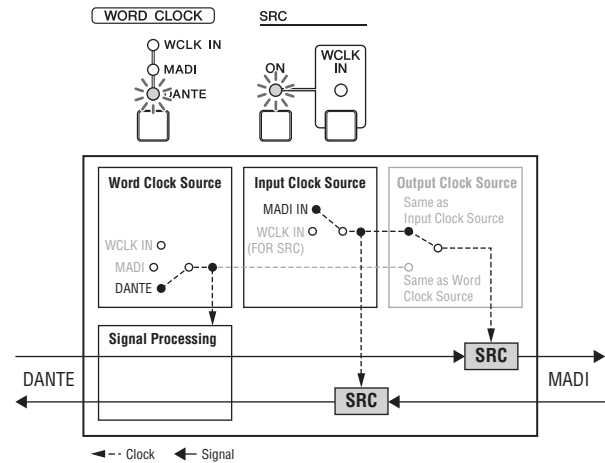

Using an external clock on the MADI-compatible devices, and syncing the unit to the Dante network:

NOTE

The same external clock supplied to MADI-compatible devices must be input to [WCLK IN FOR SRC] on the unit.

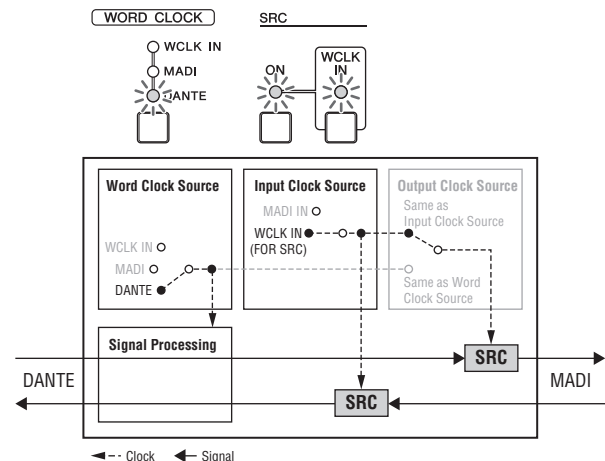

Syncing the unit to a MADI input signal

NOTE

If the unit acts as the clock follower on the Dante network, input to the unit the same MADI clock used for the device that is the clock leader. You can use Dante Controller (available from the following website) to check which device is the current clock leader.

<http://www.yamahaproaudio.com/>

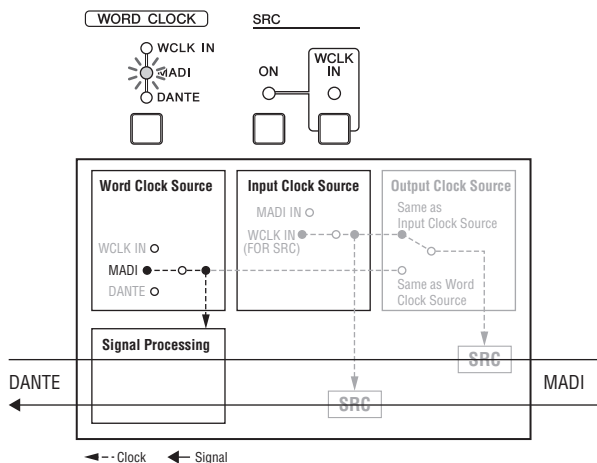

Using an external clock on MADI-compatible devices, and syncing the unit to a different external clock:

NOTE

- The same external clock supplied to MADI-compatible devices must be input to [WCLK IN FOR SRC] on the unit.
- If the unit acts as the clock follower on the Dante network, input to the unit the same external clock used for the device that is the clock leader. You can use Dante Controller (available from the following website) to check which device is the current clock leader.

<http://www.yamahaproaudio.com/>

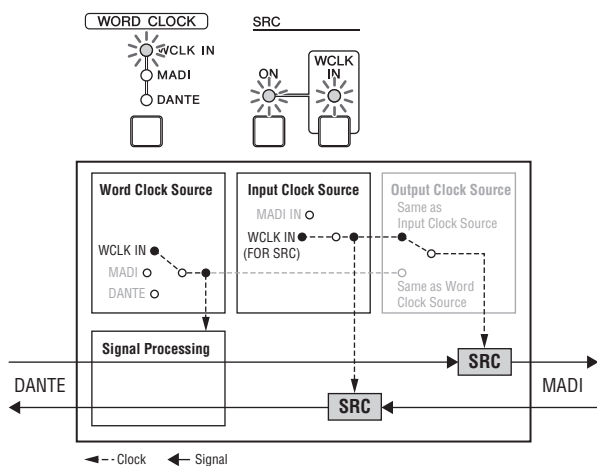

Displaying the MADI Input and Output Signals

The frame format and number of channels for the MADI input signal or output signal are displayed in the MADI [STATUS] area.

Use the MADI [STATUS] INPUT/OUTPUT key to switch between the input signal display and the output signal display.

Remote Control

RMio64-D can be remotely controlled from the NUAGE Workgroup Manager and R Remote.

You can use the NUAGE Workgroup Manager to configure items that cannot be configured from the unit's panel, such as individual settings for MADI SRC input/output controls and setting the MADI output to a different format than the MADI input.

NOTE

For the latest information about remote control compatible devices, refer to the Yamaha Pro Audio website: <http://www.yamahaproaudio.com/>

Remote Controllable/ Displayable Parameters

Parameter	Description	NUAGE Workgroup Manager	R Remote
SRC ON/OFF	Turns MADI SRC on or off.	✓	✓
SRC INPUT CLOCK SOURCE	For selecting the MADI SRC clock source: the MADI input signal or the clock input from the WCLK IN FOR SRC connector.	✓	✓
SRC OUTPUT CLOCK SOURCE	For selecting the MADI SRC clock output: the input signal or the unit's leader clock.	✓	—
INPUT RATE	Displays the frequency when the MADI input signal is automatically detected as 44.1 kHz or 48 kHz. For selecting 1Fs, 2Fs, or 4Fs in combination with the MADI input rate.	✓	✓
STATUS INPUT	Displays the status of the MADI input signal.	✓	✓
STATUS OUTPUT	Displays the status of the MADI output signal. You can also make changes to the frame format and number of channels for the MADI output signal.	✓	✓
BNC AES/ EBU OUT	For selecting the Dante input channel output from the [SYSTEM LINK OUT] connector as the AES/EBU signal.	✓	—
CLOCK	For selecting the source used as the leader clock.	✓	✓
PANEL LOCK	Locks the panel to prevent operation of the unit's controllers. Default settings are turned off.	✓	—

Control from NUAGE Workgroup Manager

When RMio64-D is operating in the NUAGE Workgroup, you can use remote control to configure the RMio64-D and use direct monitoring functions.

Direct Monitoring

When RMio64-D is operating in the NUAGE Workgroup, a “direct monitoring” function is available. Direct monitoring allows you to monitor a MADI signal output from the RMio64-D to Steinberg Nuendo as direct MADI output, in the same way as NUAGE I/O.

Direct monitoring provides latency-free monitoring of signals from audio tracks balanced with the faders in Nuendo and MADI signals routed to the OUTPUT BUS. To turn direct monitoring on or off, use the monitoring button on tracks in Nuendo where the RMio64-D is routed as input ports.



NOTE

To use direct monitoring, you must activate [Direct Monitoring] in the Nuendo [Device Setup] menu.

RMio64-D Setup

If there are multiple AIC128-D cards on a Dante network, specify the AIC128-D unit that is used in Nuendo.

To open the RMio64-D Setup within Nuendo, click “Devices,” then click “RMio64-D Setup.”

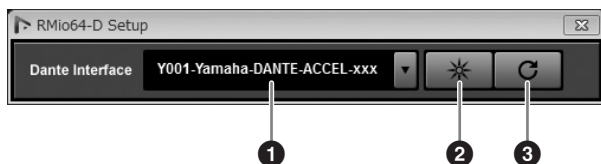

1 Dante Interface

Select the AIC128-D that is used in Nuendo.

2 Identify

When you click here, the lamp on the selected AIC128-D flashes for a few seconds. This function is convenient for identifying the selected AIC128-D.

3 Reload

When you click here, choices for the Dante interface are updated to the latest status.

Troubleshooting

The following is an abbreviated list of frequently asked questions in the past. Please check it if you run into similar problems and need help.

A mixer does not recognize the RMio64-D

- Is the Dante [Unit ID] set different ID from other Dante-compatible devices from Yamaha that connected to the same network?
- Is the network switch working properly?
The problem may be solved by turning the network switch on again.
- Is the cable defective?
The problem may be solved by replacing the cable.

Audio cuts out or distorts.

- Is the correct MADI input frequency selected? (page 14)
- If [MADI] or [WCLK IN] is selected as the word clock source, change it to [DANTE]. Keep in mind that if this remedies the problem, the clocks for the Dante network and the unit will not be synced. If you want to select [MADI] or [WCLK IN] as the word clock source, the unit must be set as the clock leader for the Dante network. For details, refer to the Dante Controller User Guide available on the website.
<http://www.yamahaproaudio.com/>

Updating

How to update the firmware?

What are the computer requirements for updating the firmware?

For information about updating the unit, refer to the firmware update guide for each product and the following website.

<http://www.yamahaproaudio.com/>

Cannot update

The problem may be solved by disabling any antivirus software and the firewall of the computer.

For other details, refer to the firmware update guide available on the website.

<http://www.yamahaproaudio.com/>

What devices should I update?

It is necessary to update multiple devices depending on the version of each device. For details, refer to the firmware compatibility available on the website.

<http://www.yamahaproaudio.com/>

Routing / Patching

A mixer is not receiving an input signal from the RMio64-D

- Is the patch of the Dante network set up correctly by Dante Controller?
- Is the patch setting in the mixer set to use the Dante Controller?
- Is the word clock setting in the mixer set to correspond to the Dante network?

How can the Dante input and output signals be patched?

Use Dante Controller to configure the audio routing (patching) of the Dante network. For details, refer to the Dante Controller User Guide available on the website.
<http://www.yamahaproaudio.com/>

Is it possible to input a signal from two RMio64-D units to one channel of the mixer?

Unlike with output, input can receive only the signal of one channel.

Is it possible to receive the input signal from RMio64-D by a separate mixer?

It can be configured using the Dante Controller. For details, refer to the Dante Controller User Guide available on the website.
<http://www.yamahaproaudio.com/>

Remote Control

I want to change the RMio64-D settings from the mixer

I want to know the devices that can remotely configure the RMio64-D

For details on RMio64-D remote control, refer to the following website.
<http://www.yamahaproaudio.com/>

Other Issues

What is the latency of the Dante network?

The latency value can be set by Dante Controller or some mixers. For details, refer to the manuals for each product.

An internal error message such as “firmware mismatch” is displayed on the device connected to the RMio64-D.

Make sure that each device has a compatible version. For details, refer to the firmware compatibility information available on the website.
<http://www.yamahaproaudio.com/>

Restoring Factory Settings

Perform the following steps to restore the factory settings.

1. Turn the unit off.
2. Turn on Dante DIP switch 2 (DOWN), and turn the unit on.

All front panel indicators (except the power indicator) flash, indicating all parameters have been restored to the factory settings.

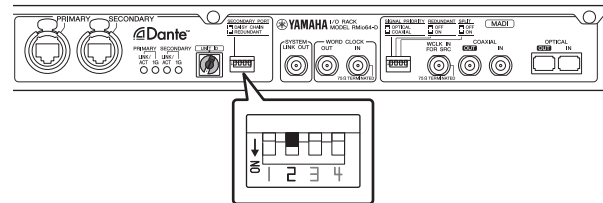

3. Turn the unit off.
4. Turn off Dante DIP switch 2 (UP).

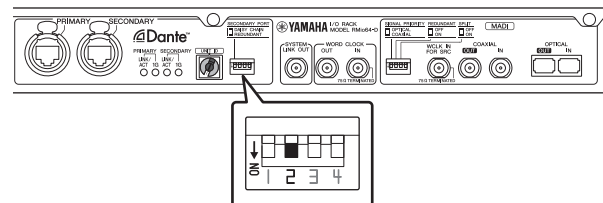

5. Turn the unit on again.

Index

Numerics

1Fs/2Fs/4Fs 8, 14

A

AC power cord
 Unlock 9, 13
AES/EBU output 10
Audio routing 14, 18

C

Connecting
 AC power 13
 Coaxial cables 12
 Daisy chain network 11
 Optical cables 13
 Redundant network (Dante) 12
 Redundant network (MADI) 13
 Star network 12

D

Dante 11
 Daisy chain network 11
 DIP switch 10, 11, 12
 Network switch 11, 12
 Patching (Audio routing) 14, 18
 Redundant Network 12
 Star Network 12
 UNIT ID 10, 11, 12
Direct monitoring 17

F

Factory Settings 18
Firmware 7, 17, 18

I

Included Accessories 4
Input rate 8, 14

L

Latency 18
Loop back 14

M

MADI
 Coaxial connection 12
 DIP switch 10, 13, 14
 Input rate 8, 14, 16
 Loop back 14
 Optical connection 13
 Redundant connection 13

MADI Split 14
MADI SRC (Sampling Rate Converter) 15

N

Network switch 11, 12

P

Panel lock 14
Patching (Audio routing) 14, 18

R

Rack mounting 7
Remote control 16, 18
Restoring Factory Settings 18
Rotary switch 10, 11, 12
Routing 14, 18

S

Signal flow 14

U

Updating 7, 17

W

Word clock 15
Word clock frequency 9
Word clock source 8, 15

Specifications

General Specifications

Sampling Frequency	Internal	44.1kHz	+4.1667%/+0.1%/-0.1%/-4.0%	±50ppm
		48kHz	+4.1667%/+0.1%/-0.1%/-4.0%	±50ppm
		88.2kHz	+4.1667%/+0.1%/-0.1%/-4.0%	±50ppm
		96kHz	+4.1667%/+0.1%/-0.1%/-4.0%	±50ppm
		176.4kHz	+4.1667%/+0.1%/-0.1%/-4.0%	±50ppm
		192kHz	+4.1667%/+0.1%/-0.1%/-4.0%	±50ppm
	External	44.1kHz	+4.1667%/+0.1%/-0.1%/-4.0%	±200ppm
		48kHz	+4.1667%/+0.1%/-0.1%/-4.0%	±200ppm
		88.2kHz	+4.1667%/+0.1%/-0.1%/-4.0%	±200ppm
		96kHz	+4.1667%/+0.1%/-0.1%/-4.0%	±200ppm
		176.4kHz	+4.1667%/+0.1%/-0.1%/-4.0%	±200ppm
		192kHz	+4.1667%/+0.1%/-0.1%/-4.0%	±200ppm
MADI Channels & Formats	fs=44.1kHz/48kHz:	MADI Single fs 44.1/48k frame, 56/64 channels		
	fs=88.2kHz/96kHz:	MADI Double fs 44.1/48k frame, 28/32 channels		
		MADI Double fs 88.2/96k frame, 28/32 channels		
	fs=176.4kHz/192kHz:	MADI Quad fs 44.1/48k frame, 14/16 channels		
SRC	SRC Lock Range:	38.59kHz – 216kHz		
	Sample Rate Ratio Limit:	6:1		
Dimensions (WxHxD) and Net Weight	480 x 44 x 374 mm, 4.7 kg			
Power Requirements (wattage)	25W			
Power Requirements (voltage and hertz)	US/Canada:	120V 60Hz		
	Japan:	100V 50/60Hz		
	China:	110 – 240V 50/60Hz		
	Korea:	220V 60Hz		
	Others:	110 – 240V 50/60Hz		
Temperature Range	Operating temperature range:	0 – 40 °C		
	Storage temperature range:	-20 – 60 °C		
Included Accessories	Owner's Manual, AC power cord			

*The contents of this manual apply to the latest specifications as of the printing date. Since Yamaha makes continuous improvements to the product, this manual may not apply to the specifications of your particular product. To obtain the latest manual, access the Yamaha website then download the manual file. Since specifications, equipment or separately sold accessories may not be the same in every locale, please check with your Yamaha dealer.

Digital I/O Characteristics

Terminal	Format	Data length	Level	Connector
Primary/Secondary	Dante	24-bit	1000Base-T	etherCON x 2

Terminal	Format	Data length	Level	Connector
MADI IN 1 – 64	AES10-2008 (MADI)	24-bit	ECL	BNC Connector
			-31 – -14dBm	SC Connector
MADI OUT 1 – 64			ECL	BNC Connector
			-20 – -14dBm	SC Connector

Control I/O Characteristics

Terminal	Level	Connector
WORD CLOCK	IN	TTL/75Ω terminated
	IN for SRC	TTL/75Ω terminated
	OUT	TTL/75Ω
System Link Out	1.0±0.2Vp-p/75Ω*	BNC Connector

*AES-3id

Dimensions

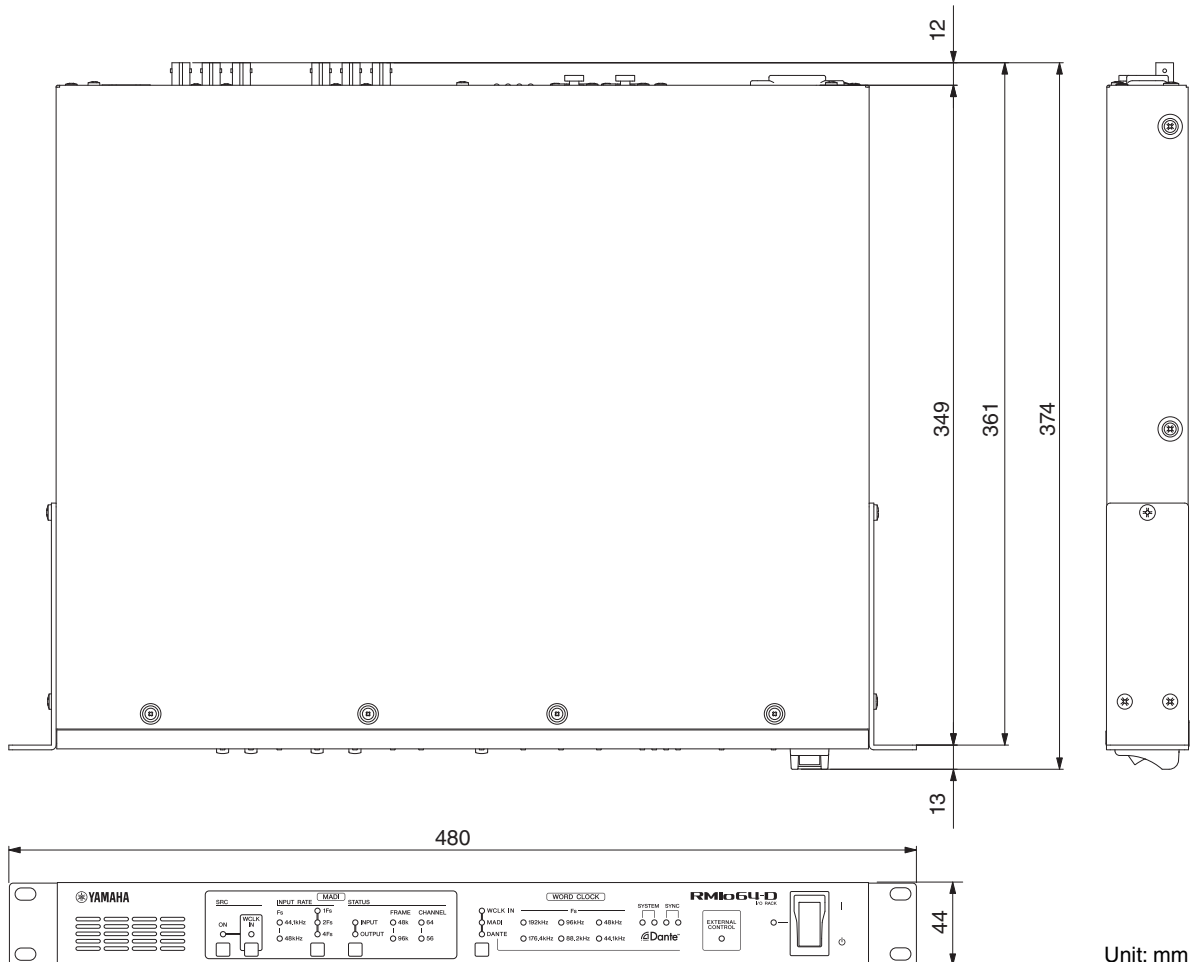

Unit: mm

Block Diagrams

[MADI INPUT] (1-64)

(up to 64ch@44.1/48kHz, up to 32ch@88.2/96kHz, up to 16ch@176.4/192kHz)

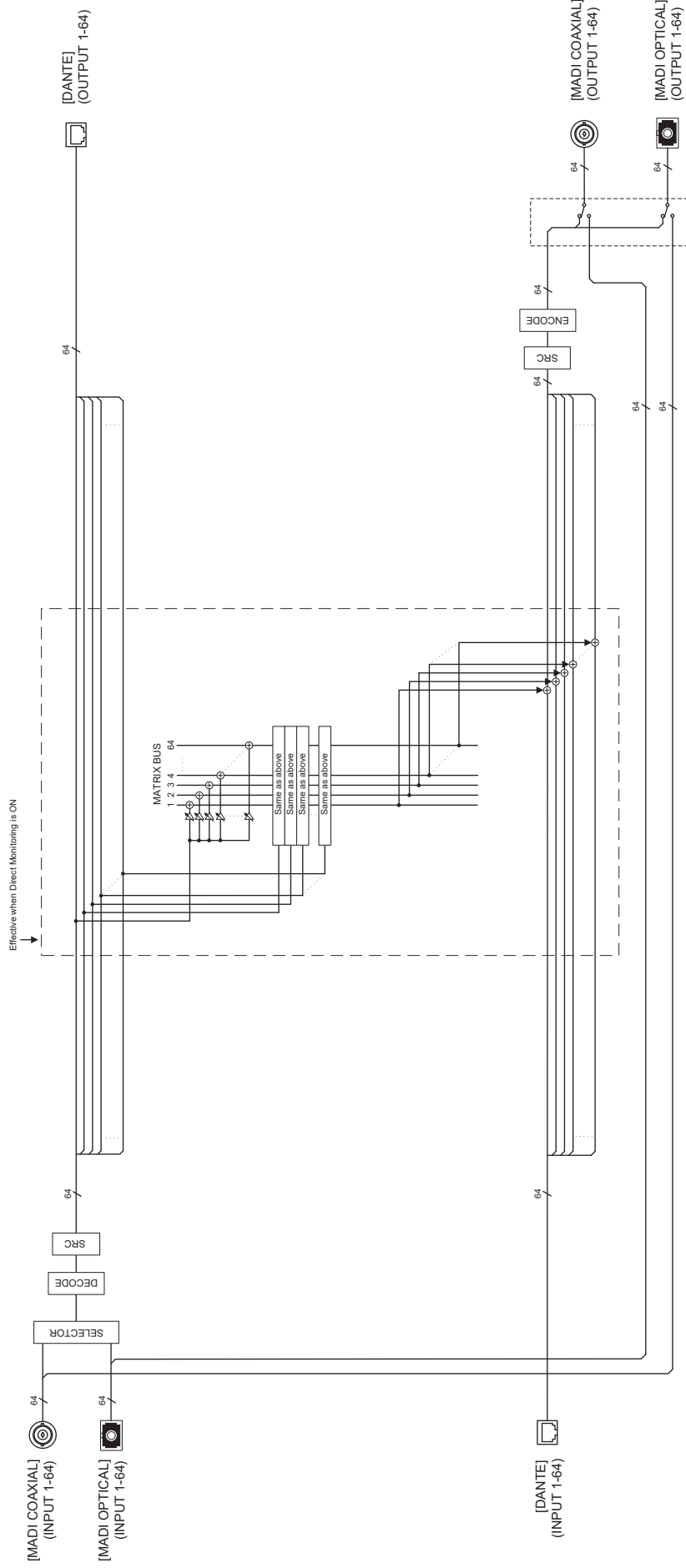

[MADI OUTPUT] (1-64)

(up to 64ch@44.1/48kHz, up to 32ch@88.2/96kHz, up to 16ch@176.4/192kHz)

GNU GENERAL PUBLIC LICENSE

Version 2, June 1991

Copyright © 1989, 1991 Free Software Foundation, Inc.
51 Franklin Street, Fifth Floor, Boston, MA 02110-1301, USA

Everyone is permitted to copy and distribute verbatim copies of this license document, but changing it is not allowed.

Preamble

The licenses for most software are designed to take away your freedom to share and change it. By contrast, the GNU General Public License is intended to guarantee your freedom to share and change free software—to make sure the software is free for all its users. This General Public License applies to most of the Free Software Foundation's software and to any other program whose authors commit to using it. (Some other Free Software Foundation software is covered by the GNU Library General Public License instead.) You can apply it to your programs, too.

When we speak of free software, we are referring to freedom, not price. Our General Public Licenses are designed to make sure that you have the freedom to distribute copies of free software (and charge for this service if you wish), that you receive source code or can get it if you want it, that you can change the software or use pieces of it in new free programs; and that you know you can do these things.

To protect your rights, we need to make restrictions that forbid anyone to deny you these rights or to ask you to surrender the rights. These restrictions translate to certain responsibilities for you if you distribute copies of the software, or if you modify it.

For example, if you distribute copies of such a program, whether gratis or for a fee, you must give the recipients all the rights that you have. You must make sure that they, too, receive or can get the source code. And you must show them these terms so they know their rights.

We protect your rights with two steps: (1) copyright the software, and (2) offer you this license which gives you legal permission to copy, distribute and/or modify the software.

Also, for each author's protection and ours, we want to make certain that everyone understands that there is no warranty for this free software. If the software is modified by someone else and passed on, we want its recipients to know that what they have is not the original, so that any problems introduced by others will not reflect on the original authors' reputations.

Finally, any free program is threatened constantly by software patents. We wish to avoid the danger that redistributors of a free program will individually obtain patent licenses, in effect making the program proprietary. To prevent this, we have made it clear that any patent must be licensed for everyone's free use or not licensed at all.

The precise terms and conditions for copying, distribution and modification follow.

TERMS AND CONDITIONS FOR COPYING, DISTRIBUTION AND MODIFICATION

0. This License applies to any program or other work which contains a notice placed by the copyright holder saying it may be distributed under the terms of this General Public License. The "Program", below, refers to any such program or work, and a "work based on the Program" means either the Program or any derivative work under copyright law: that is to say, a work containing the Program or a portion of it, either verbatim or with modifications and/or translated into another language.

(Hereinafter, translation is included without limitation in the term "modification".) Each licensee is addressed as "you".

Activities other than copying, distribution and modification are not covered by this License; they are outside its scope. The act of running the Program is not restricted, and the output from the Program is covered only if its contents constitute a work based on the Program (independent of having been made by running the Program). Whether that is true depends on what the Program does.

1. You may copy and distribute verbatim copies of the Program's source code as you receive it, in any medium, provided that you conspicuously and appropriately publish on each copy an appropriate copyright notice and disclaimer of warranty; keep intact all the notices that refer to this License and to the absence of any warranty; and give any other recipients of the Program a copy of this License along with the Program.

You may charge a fee for the physical act of transferring a copy, and you may at your option offer warranty protection in exchange for a fee.

2. You may modify your copy or copies of the Program or any portion of it, thus forming a work based on the Program, and copy and distribute such modifications or work under the terms of Section 1 above, provided that you also meet all of these conditions:

- a) You must cause the modified files to carry prominent notices stating that you changed the files and the date of any change.
- b) You must cause any work that you distribute or publish, that in whole or in part contains or is derived from the Program or any part thereof, to be licensed as a whole at no charge to all third parties under the terms of this License.
- c) If the modified program normally reads commands interactively when run, you must cause it, when started running for such interactive use in the most ordinary way, to print or display an announcement including an appropriate copyright notice and a notice that there is no warranty (or else, saying that you provide a warranty) and that users may redistribute the program under these conditions, and telling the user how to view a copy of this License. (Exception: if the Program itself is interactive but does not normally print such an announcement, your work based on the Program is not required to print an announcement.)

These requirements apply to the modified work as a whole. If identifiable sections of that work are not derived from the Program, and can be reasonably considered independent and separate works in themselves, then this License, and its terms, do not apply to those sections when you distribute them as separate works. But when you distribute the same sections as part of a whole which is a work based on the Program, the distribution of the whole must be on the terms of this License, whose permissions for other licensees extend to the entire whole, and thus to each and every part regardless of who wrote it.

Thus, it is not the intent of this section to claim rights or contest your rights to work written entirely by you; rather, the intent is to exercise the right to control the distribution of derivative or collective works based on the Program.

In addition, mere aggregation of another work not based on the Program with the Program (or with a work based on the Program) on a volume of a storage or distribution medium does not bring the other work under the scope of this License.

3. You may copy and distribute the Program (or a work based on it, under Section 2) in object code or executable form under the terms of Sections 1 and 2 above provided that you also do one of the following:

- a) Accompany it with the complete corresponding machine-readable source code, which must be distributed under the terms of Sections 1 and 2 above on a medium customarily used for software interchange; or,
- b) Accompany it with a written offer, valid for at least three years, to give any third party, for a charge no more than your cost of physically performing source distribution, a complete machine-readable copy of the corresponding source code, to be distributed under the terms of Sections 1 and 2 above on a medium customarily used for software interchange; or,
- c) Accompany it with the information you received as to the offer to distribute corresponding source code. (This alternative is allowed only for noncommercial distribution and only if you received the program in object code or executable form with such an offer, in accord with Subsection b above.)

The source code for a work means the preferred form of the work for making modifications to it. For an executable work, complete source code means all the source code for all modules it contains, plus any associated interface definition files, plus the scripts used to control compilation and installation of the executable. However, as a special exception, the source code distributed need not include anything that is normally distributed (in either source or binary form) with the major components (compiler, kernel, and so on) of the operating system on which the executable runs, unless that component itself accompanies the executable.

If distribution of executable or object code is made by offering access to copy from a designated place, then offering equivalent access to copy the source code from the same place counts as distribution of the source code, even though third parties are not compelled to copy the source along with the object code.

4. You may not copy, modify, sublicense, or distribute the Program except as expressly provided under this License. Any attempt otherwise to copy, modify, sublicense or distribute the Program is void, and will automatically terminate your rights under this License. However, parties who have received copies, or rights, from you under this License will not have their licenses terminated so long as such parties remain in full compliance.

5. You are not required to accept this License, since you have not signed it. However, nothing else grants you permission to modify or distribute the Program or its derivative works. These actions are prohibited by law if you do not accept this License. Therefore, by modifying or distributing the Program (or any work based on the Program), you indicate your acceptance of this License to do so, and all its terms and conditions for copying, distributing or modifying the Program or works based on it.

6. Each time you redistribute the Program (or any work based on the Program), the recipient automatically receives a license from the original licensor to copy, distribute or modify the Program subject to these terms and conditions. You may not impose any further restrictions on the recipients' exercise of the rights granted herein. You are not responsible for enforcing compliance by third parties to this License.

7. If, as a consequence of a court judgment or allegation of patent infringement or for any other reason (not limited to patent issues), conditions are imposed on you (whether by court order, agreement or otherwise) that contradict the conditions of this License, they do not excuse you from the conditions of this License. If you cannot distribute so as to satisfy simultaneously your obligations under this License and any other pertinent obligations, then as a consequence you may not distribute the Program at all. For example, if a patent license would not permit royalty-free redistribution of the Program by all those who receive copies directly or indirectly through you, then the only way you could satisfy both it and this License would be to refrain entirely from distribution of the Program.

If any portion of this section is held invalid or unenforceable under any particular circumstance, the balance of the section is intended to apply and the section as a whole is intended to apply in other circumstances.

It is not the purpose of this section to induce you to infringe any patents or other property right claims or to contest validity of any such claims; this section has the sole purpose of protecting the integrity of the free software distribution system, which is implemented by public license practices. Many people have made generous contributions to the wide range of software distributed through that system in reliance on consistent application of that system; it is up to the author/donor to decide if he or she is willing to distribute software through any other system and a licensee cannot impose that choice.

This section is intended to make thoroughly clear what is believed to be a consequence of the rest of this License.

8. If the distribution and/or use of the Program is restricted in certain countries either by patents or by copyrighted interfaces, the original copyright holder who places the Program under this License may add an explicit geographical distribution limitation excluding those countries, so that distribution is permitted only in or among countries not thus excluded. In such case, this License incorporates the limitation as if written in the body of this License.

9. The Free Software Foundation may publish revised and/or new versions of the General Public License from time to time. Such new versions will be similar in spirit to the present version, but may differ in detail to address new problems or concerns.

Each version is given a distinguishing version number. If the Program specifies a version number of this License which applies to it and "any later version", you have the option of following the terms and conditions either of that version or of any later version published by the Free Software Foundation. If the Program does not specify a version number of this License, you may choose any version ever published by the Free Software Foundation.

10. If you wish to incorporate parts of the Program into other free programs whose distribution conditions are different, write to the author to ask for permission. For software which is copyrighted by the Free Software Foundation, write to the Free Software Foundation; we sometimes make exceptions for this. Our decision will be guided by the two goals of preserving the free status of all derivatives of our free software and of promoting the sharing and reuse of software generally.

NO WARRANTY

11. BECAUSE THE PROGRAM IS LICENSED FREE OF CHARGE, THERE IS NO WARRANTY FOR THE PROGRAM, TO THE EXTENT PERMITTED BY APPLICABLE LAW. EXCEPT WHEN OTHERWISE STATED IN WRITING THE COPYRIGHT HOLDERS AND/OR OTHER PARTIES PROVIDE THE PROGRAM "AS IS" WITHOUT WARRANTY OF ANY KIND, EITHER EXPRESSED OR IMPLIED, INCLUDING, BUT NOT LIMITED TO, THE IMPLIED WARRANTIES OF MERCHANTABILITY AND FITNESS FOR A PARTICULAR PURPOSE. THE ENTIRE RISK AS TO THE QUALITY AND PERFORMANCE OF THE PROGRAM IS WITH YOU. SHOULD THE PROGRAM PROVE DEFECTIVE, YOU ASSUME THE COST OF ALL NECESSARY SERVICING, REPAIR OR CORRECTION.

12. IN NO EVENT UNLESS REQUIRED BY APPLICABLE LAW OR AGREED TO IN WRITING WILL ANY COPYRIGHT HOLDER, OR ANY OTHER PARTY WHO MAY MODIFY AND/OR REDISTRIBUTE THE PROGRAM AS PERMITTED ABOVE, BE LIABLE TO YOU FOR DAMAGES, INCLUDING ANY GENERAL, SPECIAL, INCIDENTAL OR CONSEQUENTIAL DAMAGES ARISING OUT OF THE USE OR INABILITY TO

USE THE PROGRAM (INCLUDING BUT NOT LIMITED TO LOSS OF DATA OR DATA BEING RENDERED INACCURATE OR LOSSES SUSTAINED BY YOU OR THIRD PARTIES OR A FAILURE OF THE PROGRAM TO OPERATE WITH ANY OTHER PROGRAMS), EVEN IF SUCH HOLDER OR OTHER PARTY HAS BEEN ADVISED OF THE POSSIBILITY OF SUCH DAMAGES.

END OF TERMS AND CONDITIONS

How to Apply These Terms to Your New Programs

If you develop a new program, and you want it to be of the greatest possible use to the public, the best way to achieve this is to make it free software which everyone can redistribute and change under these terms.

To do so, attach the following notices to the program. It is safest to attach them to the start of each source file to most effectively convey the exclusion of warranty; and each file should have at least the "copyright" line and a pointer to where the full notice is found.

one line to give the program's name and an idea of what it does.

Copyright © yyyy name of author

This program is free software; you can redistribute it and/or modify it under the terms of the GNU General Public License as published by the Free Software Foundation; either version 2 of the License, or (at your option) any later version.

This program is distributed in the hope that it will be useful, but WITHOUT ANY WARRANTY; without even the implied warranty of MERCHANTABILITY or FITNESS FOR A PARTICULAR PURPOSE. See the GNU General Public License for more details.

You should have received a copy of the GNU General Public License along with this program; if not, write to the Free Software Foundation, Inc., 51 Franklin Street, Fifth Floor, Boston, MA 02110-1301, USA.

Also add information on how to contact you by electronic and paper mail.

If the program is interactive, make it output a short notice like this when it starts in an interactive mode:

Gnomovision version 69, Copyright © year name of author

Gnomovision comes with ABSOLUTELY NO WARRANTY; for details type 'show w'. This is free software, and you are welcome to redistribute it under certain conditions; type 'show c' for details.

The hypothetical commands 'show w' and 'show c' should show the appropriate parts of the General Public License. Of course, the commands you use may be called something other than 'show w' and 'show c'; they could even be mouse-clicks or menu items—whatever suits your program.

You should also get your employer (if you work as a programmer) or your school, if any, to sign a "copyright disclaimer" for the program, if necessary. Here is a sample; alter the names:

Yoyodyne, Inc., hereby disclaims all copyright interest in the program 'Gnomovision' (which makes passes at compilers) written by James Hacker.

signature of Ty Coon, 1 April 1989

Ty Coon, President of Vice

This General Public License does not permit incorporating your program into proprietary programs. If your program is a

subroutine library, you may consider it more useful to permit linking proprietary applications with the library. If this is what you want to do, use the GNU Library General Public License instead of this License.

Note on source code distribution

For three years after the final factory shipment, you may request from Yamaha the source code for any portions of the product which are licensed under the GNU General Public License by writing to the following address:

Pro Audio Department, Audio Products Sales & Marketing Division, Yamaha Corporation
10-1 Nakazawa-cho, Naka-ku, Hamamatsu, 430-8650, JAPAN

The source code will be provided at no charge; however, we may require you to reimburse Yamaha for the cost of delivering the source code to you.

- Note that we shall bear no responsibility whatsoever for any damage arising from changes (additions/ deletions) made to the software for this product by a third party other than Yamaha (or party authorized by Yamaha).
- Note that re-use of source code released to the public domain by Yamaha is unguaranteed, and Yamaha shall not bear any responsibility whatsoever for the source code.
- The source code can be downloaded from the following address: <http://www.yamahaproaudio.com/>

Hinweis für den Zugriff auf Quellcode

In einem Zeitraum von bis zu drei Jahren nach endgültiger Auslieferung können Sie von Yamaha den Quellcode für alle Teile des Produkts anfordern, die der allgemein-öffentlichen Lizenz (General Public License) GNU unterliegen, indem Sie ein Schreiben an folgende Adresse richten:

Pro Audio Department, Audio Products Sales & Marketing Division, Yamaha Corporation
10-1 Nakazawa-cho, Naka-ku, Hamamatsu, 430-8650, JAPAN

Der Quellcode wird kostenlos zur Verfügung gestellt; es kann jedoch sein, dass wir Sie bitten, Yamaha für die durch die Lieferung entstandenen Kosten zu entschädigen.

- Bedenken Sie bitte, dass wir keine Verantwortung für Schäden übernehmen, die aus Änderungen (Hinzufügung/ Löschung) an der Software für dieses Produkt entstehen, die von Dritten außer Yamaha selbst (oder von Yamaha hierfür autorisierten Parteien) vorgenommen wurden.
- Bedenken Sie, dass die Wiederverwendung von Quellcode, der von Yamaha an die Public Domain übergeben wurde, keiner Garantie unterliegt und dass Yamaha keine Verantwortung für den Quellcode übernimmt.
- Der Quellcode kann von der folgenden Adresse heruntergeladen werden: <http://www.yamahaproaudio.com/>

Note concernant la distribution du code source

Au cours des trois années qui suivent la sortie définitive d'usine, vous pouvez demander à Yamaha le code source de toute partie du produit fournie sous licence dans le cadre d'une licence GNU General Public License en envoyant un courrier à l'adresse suivante :

Pro Audio Department, Audio Products Sales & Marketing Division, Yamaha Corporation
10-1 Nakazawa-cho, Naka-ku, Hamamatsu, 430-8650, JAPAN

Le code source vous sera fourni gratuitement. Nous pouvons toutefois vous demander de rembourser à Yamaha les frais d'expédition du code.

- Notez que nous déclinons toute responsabilité pour les dommages résultant de modifications (ajouts/suppressions) apportées au logiciel de ce produit par un tiers autre que Yamaha (ou une partie autorisée par Yamaha).
- Notez que la réutilisation du code source distribué dans le domaine public par Yamaha n'est pas garantie et que Yamaha décline toute responsabilité pour le code source.
- Vous pouvez également télécharger le code source à l'adresse suivante : <http://www.yamahaproaudio.com/>

Nota sobre la distribución del código fuente

Durante tres años tras la salida final de fábrica, puede solicitar a Yamaha el código fuente de cualquier parte del producto para el que se conceda licencia según la Licencia Pública General (GNU), enviando solicitud escrita a:

Pro Audio Department, Audio Products Sales & Marketing Division, Yamaha Corporation
10-1 Nakazawa-cho, Naka-ku, Hamamatsu, 430-8650, JAPAN

El código fuente se proporcionará sin cargo alguno; sin embargo, Yamaha podría solicitar el reembolso del coste de envío.

- Debe tenerse en cuenta que no admitiremos responsabilidad alguna por cualesquiera daños que puedan derivarse de los cambios (adiciones o eliminaciones) realizados en el software de este producto por un tercero que no sea Yamaha (o alguien autorizado por Yamaha).
- Asimismo, debe tenerse en cuenta que la reutilización del código fuente que Yamaha hace de dominio público no tiene garantía alguna, y Yamaha no asumirá responsabilidad respecto a este código.
- El código fuente se puede descargar de la siguiente dirección: <http://www.yamahaproaudio.com/>

Observação sobre a distribuição do código-fonte

Por três anos após a expedição final da fábrica, você pode solicitar da Yamaha o código-fonte para quaisquer partes do produto que sejam licenciados sob a Licença Pública Geral GNU, escrevendo para o seguinte endereço:

Pro Audio Department, Audio Products Sales & Marketing Division, Yamaha Corporation
10-1 Nakazawa-cho, Naka-ku, Hamamatsu, 430-8650, JAPAN

O código-fonte será fornecido sem custos, porém, podemos solicitar que você reembolse a Yamaha pelos custos de envio.

- Observe que não nos responsabilizamos de forma alguma por quaisquer danos decorrentes de alterações (adições/subtrações) feitas no software para este produto por terceiros externos à Yamaha (ou por partes autorizadas pela Yamaha).
- Observe que a reutilização do código-fonte liberado ao domínio público pela Yamaha não tem garantia e a Yamaha não assume qualquer responsabilidade, de qualquer forma, pelo código-fonte.
- O código-fonte pode ser baixado no seguinte endereço: <http://www.yamahaproaudio.com/>

Note sulla distribuzione del codice sorgente

Entro tre anni dalla consegna di fabbrica finale, è possibile richiedere a Yamaha il codice sorgente di qualsiasi parte del prodotto fornita con licenza GNU General Public License scrivendo al seguente indirizzo:

Pro Audio Department, Audio Products Sales & Marketing Division, Yamaha Corporation
10-1 Nakazawa-cho, Naka-ku, Hamamatsu, 430-8650, JAPAN

Il codice sorgente verrà fornito senza spese, tuttavia Yamaha richiederà un rimborso per i relativi costi di spedizione.

- Yamaha non si assume alcuna responsabilità per eventuali danni derivanti da modifiche (aggiunte/eliminazioni) effettuate al software di questo prodotto da terze parti diverse da Yamaha (o da terze parti autorizzate da Yamaha).
- Il riutilizzo del codice sorgente rilasciato come dominio pubblico da parte di Yamaha non è garantito e Yamaha non si assume alcuna responsabilità relativa al codice sorgente.
- È possibile scaricare il codice sorgente dal seguente indirizzo: <http://www.yamahaproaudio.com/>

Замечание о распространении исходного кода

В течение трех лет после отгрузки с завода можно запросить в компании Yamaha исходный код для любой категории программных продуктов, на которые распространяется Универсальная общественная лицензия GNU, обратившись по следующему адресу:

Pro Audio Department, Audio Products Sales & Marketing Division, Yamaha Corporation
10-1 Nakazawa-cho, Naka-ku, Hamamatsu, 430-8650, JAPAN

Исходный код поставляется бесплатно, однако вас могут попросить возместить корпорации Yamaha расходы по его пересылке.

- Следует отметить, что корпорация не несет ответственности за любой ущерб, возникший в результате изменений (дополнений/удалений), произведенных в программном обеспечении для данного продукта третьими лицами, не имеющими отношения к корпорации Yamaha (или не являющимися уполномоченными представителями корпорации Yamaha).
- Также следует отметить, что вторичное использование исходного кода, выпущенного для публичного использования корпорацией Yamaha, не является предметом гарантии и что Yamaha не несет ответственности за любое использование такого исходного кода.
- Исходный код можно загрузить с веб-сайта по адресу: <http://www.yamahaproaudio.com/>

ソースコード配布について

本製品の最終出荷日から3年間は、製品のソースコードのうちGNU General Public Licenseに基づいてライセンス供与された部分については、ソースコードを配布させていただきます。以下の住所にお問い合わせください。

〒430-8650 浜松市中区中沢町10-1
ヤマハ(株)音響営業統括部 PA 営業部

ソースコードの配布自体は無償ですが、ソースコードの送料につきましてはご負担いただけます。

- 弊社(または弊社認定の関係者)以外の第三者による、この製品のソフトウェアに対する変更や追加、削除などによって発生したいかなる損害に対しても、弊社は一切責任を負いません。
- 弊社により一般に公開されたソースコードの再利用は保証されておりません。ソースコードに関して弊社は一切責任を負いません。
- また、ソースコードは以下のURLでも配布しております。
<http://www.yamahaproaudio.com/>

GNU LESSER GENERAL PUBLIC LICENSE

Version 2.1, February 1999

Copyright (C) 1991, 1999 Free Software Foundation, Inc.
51 Franklin Street, Fifth Floor, Boston, MA 02110-1301 USA
Everyone is permitted to copy and distribute verbatim copies of this license document, but changing it is not allowed.

[This is the first released version of the Lesser GPL. It also counts as the successor of the GNU Library Public License, version 2, hence the version number 2.1.]

Preamble

The licenses for most software are designed to take away your freedom to share and change it. By contrast, the GNU General Public Licenses are intended to guarantee your freedom to share and change free software—to make sure the software is free for all its users.

This license, the Lesser General Public License, applies to some specially designated software packages—typically libraries—of the Free Software Foundation and other authors who decide to use it. You can use it too, but we suggest you first think carefully about whether this license or the ordinary General Public License is the better strategy to use in any particular case, based on the explanations below.

When we speak of free software, we are referring to freedom of use, not price. Our General Public Licenses are designed to make sure that you have the freedom to distribute copies of free software (and charge for this service if you wish); that you receive source code or can get it if you want it; that you can change the software and use pieces of it in new free programs; and that you are informed that you can do these things.

To protect your rights, we need to make restrictions that forbid distributors to deny you these rights or to ask you to surrender these rights. These restrictions translate to certain responsibilities for you if you distribute copies of the library or if you modify it.

For example, if you distribute copies of the library, whether gratis or for a fee, you must give the recipients all the rights that we gave you. You must make sure that they, too, receive or can get the source code. If you link other code with the library, you must provide complete object files to the recipients, so that they can relink them with the library after making changes to the library and recompiling it. And you must show them these terms so they know their rights.

We protect your rights with a two-step method: (1) we copyright the library, and (2) we offer you this license, which gives you legal permission to copy, distribute and/or modify the library.

To protect each distributor, we want to make it very clear that there is no warranty for the free library. Also, if the library is modified by someone else and passed on, the recipients should know that what they have is not the original version, so that the original author's reputation will not be affected by problems that might be introduced by others.

Finally, software patents pose a constant threat to the existence of any free program. We wish to make sure that a company cannot effectively restrict the users of a free program by obtaining a restrictive license from a patent holder. Therefore, we insist that any patent license obtained for a version of the library must be consistent with the full freedom of use specified in this license.

Most GNU software, including some libraries, is covered by the ordinary GNU General Public License. This license, the GNU Lesser General Public License, applies to certain designated libraries, and is quite different from the ordinary General Public License. We use this license for certain libraries in order to permit linking those libraries into non-free programs.

When a program is linked with a library, whether statically or using a shared library, the combination of the two is legally speaking a combined work, a derivative of the original library. The ordinary

General Public License therefore permits such linking only if the entire combination fits its criteria of freedom. The Lesser General Public License permits more lax criteria for linking other code with the library.

We call this license the "Lesser" General Public License because it does Less to protect the user's freedom than the ordinary General Public License. It also provides other free software developers Less of an advantage over competing non-free programs. These disadvantages are the reason we use the ordinary General Public License for many libraries. However, the Lesser license provides advantages in certain special circumstances.

For example, on rare occasions, there may be a special need to encourage the widest possible use of a certain library, so that it becomes a de-facto standard. To achieve this, non-free programs must be allowed to use the library. A more frequent case is that a free library does the same job as widely used non-free libraries. In this case, there is little to gain by limiting the free library to free software only, so we use the Lesser General Public License.

In other cases, permission to use a particular library in non-free programs enables a greater number of people to use a large body of free software. For example, permission to use the GNU C Library in non-free programs enables many more people to use the whole GNU operating system, as well as its variant, the GNU/Linux operating system.

Although the Lesser General Public License is Less protective of the users' freedom, it does ensure that the user of a program that is linked with the Library has the freedom and the wherewithal to run that program using a modified version of the Library.

The precise terms and conditions for copying, distribution and modification follow. Pay close attention to the difference between a "work based on the library" and a "work that uses the library". The former contains code derived from the library, whereas the latter must be combined with the library in order to run.

TERMS AND CONDITIONS FOR COPYING, DISTRIBUTION AND MODIFICATION

0. This License Agreement applies to any software library or other program which contains a notice placed by the copyright holder or other authorized party saying it may be distributed under the terms of this Lesser General Public License (also called "this License"). Each licensee is addressed as "you".

A "library" means a collection of software functions and/or data prepared so as to be conveniently linked with application programs (which use some of those functions and data) to form executables.

The "Library", below, refers to any such software library or work which has been distributed under these terms. A "work based on the Library" means either the Library or any derivative work under copyright law: that is to say, a work containing the Library or a portion of it, either verbatim or with modifications and/or translated straightforwardly into another language. (Hereinafter, translation is included without limitation in the term "modification".)

"Source code" for a work means the preferred form of the work for making modifications to it. For a library, complete source code means all the source code for all modules it contains, plus any associated interface definition files, plus the scripts used to control compilation and installation of the library.

Activities other than copying, distribution and modification are not covered by this License; they are outside its scope. The act of running a program using the Library is not restricted, and output from such a program is covered only if its contents constitute a work based on the Library (independent of the use of the Library in a tool for writing it). Whether that is true depends on what the Library does and what the program that uses the Library does.

1. You may copy and distribute verbatim copies of the Library's complete source code as you receive it, in any medium, provided that you conspicuously and appropriately publish on each copy an appropriate copyright notice and disclaimer of warranty; keep intact all the notices that refer to this License and to the absence of any warranty; and distribute a copy of this License along with the Library.

You may charge a fee for the physical act of transferring a copy, and you may at your option offer warranty protection in exchange for a fee.

2. You may modify your copy or copies of the Library or any portion of it, thus forming a work based on the Library, and copy and distribute such modifications or work under the terms of Section 1 above, provided that you also meet all of these conditions:

- a) The modified work must itself be a software library.
- b) You must cause the files modified to carry prominent notices stating that you changed the files and the date of any change.
- c) You must cause the whole of the work to be licensed at no charge to all third parties under the terms of this License.
- d) If a facility in the modified Library refers to a function or a table of data to be supplied by an application program that uses the facility, other than as an argument passed when the facility is invoked, then you must make a good faith effort to ensure that, in the event an application does not supply such function or table, the facility still operates, and performs whatever part of its purpose remains meaningful.

(For example, a function in a library to compute square roots has a purpose that is entirely well-defined independent of the application. Therefore, Subsection 2d requires that any application-supplied function or table used by this function must be optional: if the application does not supply it, the square root function must still compute square roots.)

These requirements apply to the modified work as a whole. If identifiable sections of that work are not derived from the Library, and can be reasonably considered independent and separate works in themselves, then this License, and its terms, do not apply to those sections when you distribute them as separate works. But when you distribute the same sections as part of a whole which is a work based on the Library, the distribution of the whole must be on the terms of this License, whose permissions for other licensees extend to the entire whole, and thus to each and every part regardless of who wrote it.

Thus, it is not the intent of this section to claim rights or contest your rights to work written entirely by you; rather, the intent is to exercise the right to control the distribution of derivative or collective works based on the Library.

In addition, mere aggregation of another work not based on the Library with the Library (or with a work based on the Library) on a volume of a storage or distribution medium does not bring the other work under the scope of this License.

3. You may opt to apply the terms of the ordinary GNU General Public License instead of this License to a given copy of the Library. To do this, you must alter all the notices that refer to this License, so that they refer to the ordinary GNU General Public License, version 2, instead of to this License. (If a newer version than version 2 of the ordinary GNU General Public License has appeared, then you can specify that version instead if you wish.) Do not make any other change in these notices.

Once this change is made in a given copy, it is irreversible for that copy, so the ordinary GNU General Public License applies to all subsequent copies and derivative works made from that copy.

This option is useful when you wish to copy part of the code of the Library into a program that is not a library.

4. You may copy and distribute the Library (or a portion or derivative of it, under Section 2) in object code or executable form under the terms of Sections 1 and 2 above provided that you accompany it with the complete corresponding machine-readable source code, which must be distributed under the terms of Sections 1 and 2 above on a medium customarily used for software interchange.

If distribution of object code is made by offering access to copy from a designated place, then offering equivalent access to copy the source code from the same place satisfies the requirement to distribute the source code, even though third parties are not compelled to copy the source along with the object code.

5. A program that contains no derivative of any portion of the Library, but is designed to work with the Library by being compiled or linked with it, is called a "work that uses the Library". Such a work, in

isolation, is not a derivative work of the Library, and therefore falls outside the scope of this License.

However, linking a "work that uses the Library" with the Library creates an executable that is a derivative of the Library (because it contains portions of the Library), rather than a "work that uses the library". The executable is therefore covered by this License. Section 6 states terms for distribution of such executables.

When a "work that uses the Library" uses material from a header file that is part of the Library, the object code for the work may be a derivative work of the Library even though the source code is not. Whether this is true is especially significant if the work can be linked without the Library, or if the work is itself a library. The threshold for this to be true is not precisely defined by law.

If such an object file uses only numerical parameters, data structure layouts and accessors, and small macros and small inline functions (ten lines or less in length), then the use of the object file is unrestricted, regardless of whether it is legally a derivative work. (Executables containing this object code plus portions of the Library will still fall under Section 6.)

Otherwise, if the work is a derivative of the Library, you may distribute the object code for the work under the terms of Section 6. Any executables containing that work also fall under Section 6, whether or not they are linked directly with the Library itself.

6. As an exception to the Sections above, you may also combine or link a "work that uses the Library" with the Library to produce a work containing portions of the Library, and distribute that work under terms of your choice, provided that the terms permit modification of the work for the customer's own use and reverse engineering for debugging such modifications.

You must give prominent notice with each copy of the work that the Library is used in it and that the Library and its use are covered by this License. You must supply a copy of this License. If the work during execution displays copyright notices, you must include the copyright notice for the Library among them, as well as a reference directing the user to the copy of this License. Also, you must do one of these things:

- a) Accompany the work with the complete corresponding machine-readable source code for the Library including whatever changes were used in the work (which must be distributed under Sections 1 and 2 above); and, if the work is an executable linked with the Library, with the complete machine-readable "work that uses the Library", as object code and/or source code, so that the user can modify the Library and then relink to produce a modified executable containing the modified Library. (It is understood that the user who changes the contents of definitions files in the Library will not necessarily be able to recompile the application to use the modified definitions.)
- b) Use a suitable shared library mechanism for linking with the Library. A suitable mechanism is one that (1) uses at run time a copy of the library already present on the user's computer system, rather than copying library functions into the executable, and (2) will operate properly with a modified version of the library, if the user installs one, as long as the modified version is interface-compatible with the version that the work was made with.
- c) Accompany the work with a written offer, valid for at least three years, to give the same user the materials specified in Subsection 6a, above, for a charge no more than the cost of performing this distribution.
- d) If distribution of the work is made by offering access to copy from a designated place, offer equivalent access to copy the above specified materials from the same place.
- e) Verify that the user has already received a copy of these materials or that you have already sent this user a copy.

For an executable, the required form of the "work that uses the Library" must include any data and utility programs needed for reproducing the executable from it. However, as a special exception, the materials to be distributed need not include anything that is normally distributed (in either source or binary form) with the major components (compiler, kernel, and so on) of the operating system on which the executable runs, unless that component itself accompanies the executable.

It may happen that this requirement contradicts the license restrictions of other proprietary libraries that do not normally accompany the operating system. Such a contradiction means you cannot use both them and the Library together in an executable that you distribute.

7. You may place library facilities that are a work based on the Library side-by-side in a single library together with other library facilities not covered by this License, and distribute such a combined library, provided that the separate distribution of the work based on the Library and of the other library facilities is otherwise permitted, and provided that you do these two things:

- a) Accompany the combined library with a copy of the same work based on the Library, uncombined with any other library facilities. This must be distributed under the terms of the Sections above.
- b) Give prominent notice with the combined library of the fact that part of it is a work based on the Library, and explaining where to find the accompanying uncombined form of the same work.

8. You may not copy, modify, sublicense, link with, or distribute the Library except as expressly provided under this License. Any attempt otherwise to copy, modify, sublicense, link with, or distribute the Library is void, and will automatically terminate your rights under this License. However, parties who have received copies, or rights, from you under this License will not have their licenses terminated so long as such parties remain in full compliance.

9. You are not required to accept this License, since you have not signed it. However, nothing else grants you permission to modify or distribute the Library or its derivative works. These actions are prohibited by law if you do not accept this License. Therefore, by modifying or distributing the Library (or any work based on the Library), you indicate your acceptance of this License to do so, and all its terms and conditions for copying, distributing or modifying the Library or works based on it.

10. Each time you redistribute the Library (or any work based on the Library), the recipient automatically receives a license from the original licensor to copy, distribute, link with or modify the Library subject to these terms and conditions. You may not impose any further restrictions on the recipients' exercise of the rights granted herein. You are not responsible for enforcing compliance by third parties with this License.

11. If, as a consequence of a court judgment or allegation of patent infringement or for any other reason (not limited to patent issues), conditions are imposed on you (whether by court order, agreement or otherwise) that contradict the conditions of this License, they do not excuse you from the conditions of this License. If you cannot distribute so as to satisfy simultaneously your obligations under this License and any other pertinent obligations, then as a consequence you may not distribute the Library at all. For example, if a patent license would not permit royalty-free redistribution of the Library by all those who receive copies directly or indirectly through you, then the only way you could satisfy both it and this License would be to refrain entirely from distribution of the Library.

If any portion of this section is held invalid or unenforceable under any particular circumstance, the balance of the section is intended to apply, and the section as a whole is intended to apply in other circumstances.

It is not the purpose of this section to induce you to infringe any patents or other property right claims or to contest validity of any such claims; this section has the sole purpose of protecting the integrity of the free software distribution system which is implemented by public license practices. Many people have made generous contributions to the wide range of software distributed through that system in reliance on consistent application of that system; it is up to the author/donor to decide if he or she is willing to distribute software through any other system and a licensee cannot impose that choice.

This section is intended to make thoroughly clear what is believed to be a consequence of the rest of this License.

12. If the distribution and/or use of the Library is restricted in certain countries either by patents or by copyrighted interfaces, the original

copyright holder who places the Library under this License may add an explicit geographical distribution limitation excluding those countries, so that distribution is permitted only in or among countries not thus excluded. In such case, this License incorporates the limitation as if written in the body of this License.

13. The Free Software Foundation may publish revised and/or new versions of the Lesser General Public License from time to time. Such new versions will be similar in spirit to the present version, but may differ in detail to address new problems or concerns.

Each version is given a distinguishing version number. If the Library specifies a version number of this License which applies to it and "any later version", you have the option of following the terms and conditions either of that version or of any later version published by the Free Software Foundation. If the Library does not specify a license version number, you may choose any version ever published by the Free Software Foundation.

14. If you wish to incorporate parts of the Library into other free programs whose distribution conditions are incompatible with these, write to the author to ask for permission. For software which is copyrighted by the Free Software Foundation, write to the Free Software Foundation; we sometimes make exceptions for this. Our decision will be guided by the two goals of preserving the free status of all derivatives of our free software and of promoting the sharing and reuse of software generally.

NO WARRANTY

15. BECAUSE THE LIBRARY IS LICENSED FREE OF CHARGE, THERE IS NO WARRANTY FOR THE LIBRARY, TO THE EXTENT PERMITTED BY APPLICABLE LAW. EXCEPT WHEN OTHERWISE STATED IN WRITING THE COPYRIGHT HOLDERS AND/OR OTHER PARTIES PROVIDE THE LIBRARY "AS IS" WITHOUT WARRANTY OF ANY KIND, EITHER EXPRESSED OR IMPLIED, INCLUDING, BUT NOT LIMITED TO, THE IMPLIED WARRANTIES OF MERCHANTABILITY AND FITNESS FOR A PARTICULAR PURPOSE. THE ENTIRE RISK AS TO THE QUALITY AND PERFORMANCE OF THE LIBRARY IS WITH YOU. SHOULD THE LIBRARY PROVE DEFECTIVE, YOU ASSUME THE COST OF ALL NECESSARY SERVICING, REPAIR OR CORRECTION.

16. IN NO EVENT UNLESS REQUIRED BY APPLICABLE LAW OR AGREED TO IN WRITING WILL ANY COPYRIGHT HOLDER, OR ANY OTHER PARTY WHO MAY MODIFY AND/OR REDISTRIBUTE THE LIBRARY AS PERMITTED ABOVE, BE LIABLE TO YOU FOR DAMAGES, INCLUDING ANY GENERAL, SPECIAL, INCIDENTAL OR CONSEQUENTIAL DAMAGES ARISING OUT OF THE USE OR INABILITY TO USE THE LIBRARY (INCLUDING BUT NOT LIMITED TO LOSS OF DATA OR DATA BEING RENDERED INACCURATE OR LOSSES SUSTAINED BY YOU OR THIRD PARTIES OR A FAILURE OF THE LIBRARY TO OPERATE WITH ANY OTHER SOFTWARE), EVEN IF SUCH HOLDER OR OTHER PARTY HAS BEEN ADVISED OF THE POSSIBILITY OF SUCH DAMAGES.

END OF TERMS AND CONDITIONS

How to Apply These Terms to Your New Libraries

If you develop a new library, and you want it to be of the greatest possible use to the public, we recommend making it free software that everyone can redistribute and change. You can do so by permitting redistribution under these terms (or, alternatively, under the terms of the ordinary General Public License).

To apply these terms, attach the following notices to the library. It is safest to attach them to the start of each source file to most effectively convey the exclusion of warranty; and each file should have at least the "copyright" line and a pointer to where the full notice is found.

one line to give the library's name and an idea of what it does.
Copyright (C) *year name of author*

This library is free software; you can redistribute it and/or modify it under the terms of the GNU Lesser General Public License as published by the Free Software Foundation; either version 2.1 of the License, or (at your option) any later version.

This library is distributed in the hope that it will be useful, but WITHOUT ANY WARRANTY; without even the implied warranty of MERCHANTABILITY or FITNESS FOR A PARTICULAR PURPOSE. See the GNU Lesser General Public License for more details.

You should have received a copy of the GNU Lesser General Public License along with this library; if not, write to the Free Software Foundation, Inc., 51 Franklin Street, Fifth Floor, Boston, MA 02110-1301 USA

Also add information on how to contact you by electronic and paper mail.

You should also get your employer (if you work as a programmer) or your school, if any, to sign a "copyright disclaimer" for the library, if necessary. Here is a sample; alter the names:

Yoyodyne, Inc., hereby disclaims all copyright interest in the library 'Frob' (a library for tweaking knobs) written by James Random Hacker.

signature of Ty Coon, 1 April 1990
Ty Coon, President of Vice

That's all there is to it!

Note on source code distribution

For three years after the final factory shipment, you may request from Yamaha the source code for any portions of the product which are licensed under the GNU Lesser General Public License by writing to the following address:

Pro Audio Department, Audio Products Sales & Marketing Division,
Yamaha Corporation
10-1 Nakazawa-cho, Naka-ku, Hamamatsu, 430-8650, JAPAN

The source code will be provided at no charge; however, we may require you to reimburse Yamaha for the cost of delivering the source code to you.

- Note that we shall bear no responsibility whatsoever for any damage arising from changes (additions/ deletions) made to the software for this product by a third party other than Yamaha (or party authorized by Yamaha).
- Note that re-use of source code released to the public domain by Yamaha is unguaranteed, and Yamaha shall not bear any responsibility whatsoever for the source code.
- The source code can be downloaded from the following address: <http://www.yamahaproaudio.com/>

Hinweis für den Zugriff auf Quellcode

In einem Zeitraum von bis zu drei Jahren nach endgültiger Auslieferung können Sie von Yamaha den Quellcode für alle Teile des Produkts anfordern, die der geringfügigeren allgemeinen öffentlichen Lizenz (Lesser General Public License) GNU unterliegen, indem Sie ein Schreiben an folgende Adresse richten:

Pro Audio Department, Audio Products Sales & Marketing Division,
Yamaha Corporation
10-1 Nakazawa-cho, Naka-ku, Hamamatsu, 430-8650, JAPAN

Der Quellcode wird kostenlos zur Verfügung gestellt; es kann jedoch sein, dass wir Sie bitten, Yamaha für die durch die Lieferung entstandenen Kosten zu entschädigen.

- Bedenken Sie bitte, dass wir keine Verantwortung für Schäden übernehmen, die aus Änderungen (Hinzufügung/Löschung) an der Software für dieses Produkt entstehen, die von Dritten außer Yamaha selbst (oder von Yamaha hierfür autorisierten Parteien) vorgenommen wurden.
- Bedenken Sie, dass die Wiederverwendung von Quellcode, der von Yamaha an die Public Domain übergeben wurde, keiner

Garantie unterliegt und dass Yamaha keine Verantwortung für den Quellcode übernimmt.

- Der Quellcode kann von der folgenden Adresse heruntergeladen werden: <http://www.yamahaproaudio.com/>

Note concernant la distribution du code source

Au cours des trois années qui suivent la sortie définitive d'usine, vous pouvez demander à Yamaha le code source de toute partie du produit fournie sous licence dans le cadre d'une licence GNU Lesser General Public License en envoyant un courrier à l'adresse suivante:

Pro Audio Department, Audio Products Sales & Marketing Division,
Yamaha Corporation
10-1 Nakazawa-cho, Naka-ku, Hamamatsu, 430-8650, JAPAN

Le code source vous sera fourni gratuitement. Nous pouvons toutefois vous demander de rembourser à Yamaha les frais d'expédition du code.

- Notez que nous déclinons toute responsabilité pour les dommages résultant de modifications (ajouts/suppressions) apportées au logiciel de ce produit par un tiers autre que Yamaha (ou une partie autorisée par Yamaha).
- Notez que la réutilisation du code source distribué dans le domaine public par Yamaha n'est pas garantie et que Yamaha décline toute responsabilité pour le code source.
- Vous pouvez également télécharger le code source à l'adresse suivante: <http://www.yamahaproaudio.com/>

Nota sobre la distribución del código fuente

Durante tres años tras la salida final de fábrica, puede solicitar a Yamaha el código fuente de cualquier parte del producto para el que se conceda licencia según la Licencia Pública General Reducida de GNU, enviando solicitud escrita a:

Pro Audio Department, Audio Products Sales & Marketing Division,
Yamaha Corporation
10-1 Nakazawa-cho, Naka-ku, Hamamatsu, 430-8650, JAPAN

El código fuente se proporcionará sin cargo alguno; sin embargo, Yamaha podría solicitar el reembolso del coste de envío.

- Debe tenerse en cuenta que no admitiremos responsabilidad alguna por cualesquiera daños que puedan derivarse de los cambios (adiciones o eliminaciones) realizados en el software de este producto por un tercero que no sea Yamaha (o alguien autorizado por Yamaha).
- Asimismo, debe tenerse en cuenta que la reutilización del código fuente que Yamaha hace de dominio público no tiene garantía alguna, y Yamaha no asumirá responsabilidad respecto a este código.
- El código fuente se puede descargar de la siguiente dirección: <http://www.yamahaproaudio.com/>

Observação sobre a distribuição do código-fonte

Por três anos após a expedição final da fábrica, você pode solicitar à Yamaha o código-fonte de quaisquer partes do produto que estejam licenciadas sob a Licença Pública Geral GNU Lesser escrevendo para o seguinte endereço:

Pro Audio Department, Audio Products Sales & Marketing Division,
Yamaha Corporation
10-1 Nakazawa-cho, Naka-ku, Hamamatsu, 430-8650, JAPAN

O código-fonte será fornecido sem custos, porém, podemos solicitar que você reembolse a Yamaha pelos custos de envio.

- Observe que não nos responsabilizamos de forma alguma por quaisquer danos decorrentes de alterações (adições/subtrações) feitas no software para este produto por terceiros externos à Yamaha (ou por partes autorizadas pela Yamaha).

- Observe que a reutilização do código-fonte liberado ao domínio público pela Yamaha não tem garantia e a Yamaha não assume qualquer responsabilidade, de qualquer forma, pelo código-fonte.
- O código-fonte pode ser baixado no seguinte endereço:
<http://www.yamahaproaudio.com/>

Note sulla distribuzione del codice sorgente

Entro tre anni dalla consegna di fabbrica finale, è possibile richiedere a Yamaha il codice sorgente di qualsiasi parte del prodotto fornita con licenza GNU Lesser General Public License scrivendo al seguente indirizzo:

Pro Audio Department, Audio Products Sales & Marketing Division,
Yamaha Corporation
10-1 Nakazawa-cho, Naka-ku, Hamamatsu, 430-8650, JAPAN

Il codice sorgente verrà fornito senza spese, tuttavia Yamaha richiederà un rimborso per i relativi costi di spedizione.

- Yamaha non si assume alcuna responsabilità per eventuali danni derivanti da modifiche (aggiunte/eliminazioni) effettuate al software di questo prodotto da terze parti diverse da Yamaha (o da terze parti autorizzate da Yamaha).
- Il riutilizzo del codice sorgente rilasciato come dominio pubblico da parte di Yamaha non è garantito e Yamaha non si assume alcuna responsabilità relativa al codice sorgente.
- È possibile scaricare il codice sorgente dal seguente indirizzo:
<http://www.yamahaproaudio.com/>

Замечание о распространении исходного кода

В течение трех лет после отгрузки с завода можно запросить в компании Yamaha исходный код для любой категории программных продуктов, на которые распространяется Универсальная общественная лицензия ограниченного применения GNU, обратившись по следующему адресу:

Pro Audio Department, Audio Products Sales & Marketing Division,
Yamaha Corporation
10-1 Nakazawa-cho, Naka-ku, Hamamatsu, 430-8650, JAPAN

Исходный код поставляется бесплатно, однако вас могут попросить возместить корпорации Yamaha расходы по его пересылке.

- Следует отметить, что корпорация не несет ответственности за любой ущерб, возникший в результате изменений (дополнений/удалений), произведенных в программном обеспечении для данного продукта третьими лицами, не имеющими отношения к корпорации Yamaha (или не являющимися уполномоченными представителями корпорации Yamaha).
- Также следует отметить, что вторичное использование исходного кода, выпущенного для публичного использования корпорацией Yamaha, не является предметом гарантии и что Yamaha не несет ответственности за любое использование такого исходного кода.
- Исходный код можно загрузить с веб-сайта по адресу:
<http://www.yamahaproaudio.com/>

ソースコード配布について

本製品の最終出荷日から3年間は、製品のソースコードのうち GNU Lesser General Public License に基づいてライセンス供与された部分のソースコードを配布させていただきます。以下の住所にお問い合わせください。

〒430-8650 浜松市中区中沢町 10-1
ヤマハ(株)音響営業統括部 PA 営業部

ソースコードの配布自体は無償ですが、ソースコードの送料につきましてはご負担いただきます。

- 弊社(または弊社認定の関係者)以外の第三者による、この製品のソフトウェアに対する変更や追加、削除などによって発生したいかなる損害に対しても、弊社は一切責任を負いません。
- 弊社により一般に公開されたソースコードの再利用は保証されておりません。ソースコードに関して弊社は一切責任を負いません。
- また、ソースコードは以下の URL でも配布しております。
<http://www.yamahaproaudio.com/>

Important Notice: Guarantee Information for customers in European Economic Area (EEA) and Switzerland

Important Notice: Guarantee Information for customers in EEA* and Switzerland For detailed guarantee information about this Yamaha product, and Pan-EEA* and Switzerland warranty service, please either visit the website address below (Printable file is available at our website) or contact the Yamaha representative office for your country. * EEA: European Economic Area	English
Wichtiger Hinweis: Garantie-Information für Kunden in der EWR* und der Schweiz Für nähere Garantie-Information über dieses Produkt von Yamaha, sowie über den Pan-EWR*- und Schweizer Garantieservice, besuchen Sie bitte entweder die folgend angegebene Internetadresse (eine druckfähige Version befindet sich auch auf unserer Webseite), oder wenden Sie sich an den für Ihr Land zuständigen Yamaha-Vertrieb. *EWR: Europäischer Wirtschaftsraum	Deutsch
Remarque importante: informations de garantie pour les clients de l'EEE et la Suisse Pour des informations plus détaillées sur la garantie de ce produit Yamaha et sur le service de garantie applicable dans l'ensemble de l'EEE ainsi qu'en Suisse, consultez notre site Web à l'adresse ci-dessous (le fichier imprimable est disponible sur notre site Web) ou contactez directement Yamaha dans votre pays de résidence. * EEE : Espace Economique Européen	Français
Belangrijke mededeling: Garantie-informatie voor klanten in de EER* en Zwitserland Voor gedetailleerde garantie-informatie over dit Yamaha-product en de garantieservice in heel de EER* en Zwitserland, gaat u naar de onderstaande website (u vindt een afdrukbaar bestand op onze website) of neemt u contact op met de vertegenwoordiging van Yamaha in uw land. * EER: Europese Economische Ruimte	Nederlands
Aviso importante: información sobre la garantía para los clientes del EEE* y Suiza Para una información detallada sobre este producto Yamaha y sobre el soporte de garantía en la zona EEE* y Suiza, visite la dirección web que se incluye más abajo (la versión del archivo para imprimir esta disponible en nuestro sitio web) o póngase en contacto con el representante de Yamaha en su país. * EEE: Espacio Económico Europeo	Español
Avviso importante: informazioni sulla garanzia per i clienti residenti nell'EEA* e in Svizzera Per informazioni dettagliate sulla garanzia relativa a questo prodotto Yamaha e l'assistenza in garanzia nei paesi EEA* e in Svizzera, potete consultare il sito Web all'indirizzo riportato di seguito (è disponibile il file in formato stampabile) oppure contattare l'ufficio di rappresentanza locale della Yamaha. * EEA: Area Economica Europea	Italiano
Aviso importante: informações sobre as garantias para clientes da AEE* e da Suíça Para obter uma informação pormenorizada sobre este produto da Yamaha e sobre o serviço de garantia na AEE* e na Suíça, visite o site a seguir (o arquivo para impressão está disponível no nosso site) ou entre em contato com o escritório de representação da Yamaha no seu país. * AEE: Área Económica Europeia	Português
Σημαντική σημείωση: Πληροφορίες εγγύησης για τους πελάτες στον ΕΟΧ* και Ελλάδα Για λεπτομερείς πληροφορίες εγγύησης σχετικά με το παρόν προϊόν της Yamaha και την κάλυψη εγγύησης σε όλες τις χώρες του ΕΟΧ και την Ελλάδα, επισκεφτείτε την παρακάτω ιστοσελίδα (Εκτυπώσιμη μορφή είναι διαθέσιμη στην ιστοσελίδα μας) ή απευθυνθείτε στην αντιπροσωπεία της Yamaha στη χώρα σας. * ΕΟΧ: Ευρωπαϊκός Οικονομικός Χώρος	Ελληνικά
Viktigt: Garantiinformation för kunder i EES-området* och Schweiz För detaljerad information om denna Yamahaprodukt samt garantiservice i hela EES-området* och Schweiz kan du antingen besöka nedanstående webbadress (en utskriftsvänlig fil finns på webbplatsen) eller kontakta Yamahas officiella representant i ditt land. * EES: Europeiska Ekonomiska Samarbetsområdet	Svenska
Viktig merknad: Garantiinformasjon for kunder i EØS* og Sveits Detaljert garantiinformasjon om dette Yamaha-produktet og garantiservice for hele EØS-området* og Sveits kan fås enten ved å besøke nettstedene nedenfor (utskriftsversjon finnes på våre nettsider) eller kontakte Yamahas kontoret i landet der du bor. *EØS: Det europeiske økonomiske samarbeidsområdet	Norsk
Vigtig oplysning: Garantioplysninger til kunder i EØ* og Schweiz De kan finde detaljerede garantioplysninger om dette Yamaha-produkt og den fælles garantiserviceordning for EØ* (og Schweiz) ved at besøge det websted, der er angivet nedenfor (der findes en fil, som kan udskrives, på vores websted), eller ved at kontakte Yamahas nationale repræsentationskontor i det land, hvor De bor. * EØ: Det Europæiske Økonomiske Område	Dansk
Tärkeä ilmoitus: Takuutiedot Euroopan talousalueen (ETA)* ja Sveitsin asiakkaille Tämän Yamaha-tuotteen sekä ETA-alueen ja Sveitsin takuuta koskevat yksityiskohtaiset tiedot saatte alla olevasta nettiosoitteesta. (Tulostettava tiedosto saatavissa sivustollamme.) Voitte myös ottaa yhteyttä paikalliseen Yamaha-edustajaan. *ETA: Euroopan talousalue	Suomi
Ważne: Warunki gwarancyjne obowiązujące w EOG* i Szwajcarii Aby dowiedzieć się więcej na temat warunków gwarancyjnych tego produktu firmy Yamaha i serwisu gwarancyjnego w całym EOG* i Szwajcarii, należy odwiedzić wskazaną poniżej stronę internetową (Plik gotowy do wydruku znajduje się na naszej stronie internetowej) lub skontaktować się z przedstawicielstwem firmy Yamaha w swoim kraju. * EOG — Europejski Obszar Gospodarczy	Polski
Důležité oznámení: Záruční informace pro zákazníky v EHS* a ve Švýcarsku Podrobné záruční informace o tomto produktu Yamaha a záručním servisu v celém EHS* a ve Švýcarsku naleznete na níže uvedené webové adrese (soubor k tisku je dostupný na našich webových stránkách) nebo se můžete obrátit na zástupce firmy Yamaha ve své zemi. * EHS: Evropský hospodářský prostor	Česky
Fontos figyelemzetés: Garancia-információk az EGT* területén és Svájcban élő vásárlók számára A jelen Yamaha termékre vonatkozó részletes garancia-információk, valamint az EGT*-re és Svájcra kiterjedő garanciális szolgáltatás tekintetében keresse fel webhelyünket az alábbi címen (a webhelyen nyomtatható fájl is található), vagy pedig lépjen kapcsolatba az országában működő Yamaha képviselői irodával. * EGT: Európai Gazdasági Térség	Magyar
Oluline märkus: Garantiiteave Euroopa Majanduspiirkonna (EMP)* ja Šveitsi klientidele Täpsemat teabes saamiseks selle Yamaha toote garantii ning kogu Euroopa Majanduspiirkonna ja Šveitsi garantiiteeninduse kohta, külastage palun veebisaiti alljärgneval aadressil (meie saidil on saadaval printitav fail) või pöörduge Teie regiooni Yamaha esinduse poole. * EMP: Euroopa Majanduspiirkond	Eesti keel
Svarīgs paziņojums: garantijas informācija klientiem EEZ* un Šveicē Lai saņemtu detalizētu garantijas informāciju par šo Yamaha produktu, kā arī garantijas apkalpošanu EEZ* un Šveicē, lūdzmu, apmeklējiet zemāk norādīto tīmekļa vietnes adresi (tīmekļa vietnē ir pieejams drukājams fails) vai sazinieties ar jūsu valsti apkalpojošo Yamaha pārstāvniecību. * EEZ: Eiropas Ekonomikas zona	Latviešu
Dėmesio: informacija dėl garantijos pirkėjams EEE* ir Šveicarijoje Jei reikia išsamios informacijos apie šį „Yamaha“ produktą ir jo techninę priežiūrą visoje EEE* ir Šveicarijoje, apsilankykite mūsų svetainėje toliau nurodytu adresu (svetainėje yra spausdintinas failas) arba kreipkitės į „Yamaha“ atstovybę savo šaliai. *EEE – Europos ekonominė erdvė	Lietuvių kalba
Dôležité upozornenie: Informácie o záruke pre zákazníkov v EHP* a Švajčiarsku Podrobné informácie o záruke týkajúce sa tohto produktu od spoločnosti Yamaha a garančnom servise v EHP* a Švajčiarsku nájdete na webovej stránke uvedenej nižšie (na našej webovej stránke je k dispozícii súbor na tlač) alebo sa obráťte na zástupcu spoločnosti Yamaha vo svojej krajine. * EHP: Európsky hospodársky priestor	Slovenčina
Pomembno obvestilo: Informacije o garanciji za kupce v EGP* in Švici Za podrobnejše informacije o tem Yamahinem izdelku ter garancijskem servisu v celotnem EGP in Švici, obiščite spletno mesto, ki je navedeno spodaj (natisljiva datoteka je na voljo na našem spletnem mestu), ali se obrnite na Yamahinega predstavnika v svoji državi. * EGP: Evropski gospodarski prostor	Slovenščina
Важно съобщение: Информация за гаранцията за клиенти в ЕИП* и Швейцария За подробна информация за гаранцията за този продукт на Yamaha и гаранционното обслужване в паневропейската зона на ЕИП* и Швейцария или посетете посочения по-долу уеб сайт (на нашия уеб сайт има файл за печат), или се свържете с представителния офис на Yamaha във вашата страна. * ЕИП: Европейско икономическо пространство	Български език
Notificare importantă: Informații despre garanție pentru clienții din SEE* și Elveția Pentru informații detaliate privind acest produs Yamaha și serviciul de garanție Pan-SEE* și Elveția, vizitați site-ul la adresa de mai jos (fișierul imprimabil este disponibil pe site-ul nostru) sau contactați biroul reprezentanței Yamaha din țara dumneavoastră. * SEE: Spațiul Economic European	Limba română
Važna obavijest: Informacije o jamstvu za države EGP-a i Švicarske Za detaljne informacije o jamstvu za ovaj Yamahin proizvod te jamstvenom servisu za cijeli EGP i Švicarsku, molimo Vas da posjetite web-stranicu navedenu u nastavku ili kontaktirate ovlaštenog Yamahinog dobavljača u svojoj zemlji. * EGP: Europski gospodarski prostor	Hrvatski

<https://europe.yamaha.com/warranty/>

ADDRESS LIST

NORTH AMERICA

CANADA

Yamaha Canada Music Ltd.
135 Milner Avenue, Toronto, Ontario,
M1S 3R1, Canada
Tel: +1-416-298-1311

U.S.A.

Yamaha Corporation of America
6600 Orangethorpe Avenue, Buena Park, CA
90620, U.S.A.
Tel: +1-714-522-9011

CENTRAL & SOUTH AMERICA

MEXICO

Yamaha de México, S.A. de C.V.
Av. Insurgentes Sur 1647 Piso 9, Col. San José
Insurgentes, Delegación Benito Juárez, CDMX,
C.P. 03900, México
Tel: +52-55-5804-0600

BRAZIL

Yamaha Musical do Brasil Ltda.
Praça Professor José Lannes, 40-Cjs 21 e 22,
Brooklin Paulista Novo CEP 04571-100 – São
Paulo – SP, Brazil
Tel: +55-11-3704-1377

ARGENTINA

**Yamaha Music Latin America, S.A.,
Sucursal Argentina**
Olga Cossettini 1553, Piso 4 Norte,
Madero Este-C1107CEK,
Buenos Aires, Argentina
Tel: +54-11-4119-7000

PANAMA AND OTHER LATIN AMERICAN/CARIBBEAN REGIONS

Yamaha Music Latin America, S.A.
Edif. Torre Banco General, Piso 7, Urbanización
Marbella, Calle 47 y Aquilino de la Guardia,
Ciudad de Panamá, República de Panamá
Tel: +507-269-5311

EUROPE

THE UNITED KINGDOM/IRELAND

Yamaha Music Europe GmbH (UK)
Sherbourne Drive, Tilbrook, Milton Keynes,
MK7 8BL, U.K.
Tel: +44-1908-366700

GERMANY

Yamaha Music Europe GmbH
Siemensstrasse 22-34, 25462 Rellingen, Germany
Tel: +49-4101-303-0

SWITZERLAND/LIECHTENSTEIN

**Yamaha Music Europe GmbH, Branch
Switzerland in Thalwil**
Seestrasse 18a, 8800 Thalwil, Switzerland
Tel: +41-44-3878080

AUSTRIA/BULGARIA/ CZECH REPUBLIC/HUNGARY/ ROMANIA/SLOVAKIA/SLOVENIA

**Yamaha Music Europe GmbH
Branch Austria**
Schleiergasse 20, 1100 Wien, Austria
Tel: +43-1-60203900

POLAND

**Yamaha Music Europe
Sp.z o.o. Oddział w Polsce**
ul. Młynarska 48, 01-171 Warszawa, Poland
Tel: +48-22-880-08-88

MALTA

Olimpus Music Ltd.
Valletta Road, Mosta MST9010, Malta
Tel: +356-2133-2093

NETHERLANDS/BELGIUM/ LUXEMBOURG

Yamaha Music Europe Branch Benelux
Wattbaan 1 3439ML Nieuwegein, The Netherlands
Tel: +31-347-358040

FRANCE

Yamaha Music Europe
7 rue Ambroise Croizat, Zone d'activités de Pariest,
77183 Croissy-Beaubourg, France
Tel: +33-1-6461-4000

ITALY

Yamaha Music Europe GmbH, Branch Italy
Via Tinelli N.67/69 20855 Gerno di Lesmo (MB),
Italy
Tel: +39-039-9065-1

SPAIN/PORTUGAL

**Yamaha Music Europe GmbH Ibérica, Sucursal
en España**
Ctra. de la Coruña km. 17,200, 28231
Las Rozas de Madrid, Spain
Tel: +34-91-639-88-88

GREECE

Philippou Nakas S.A. The Music House
19th Klm. Leof. Lavriou 190 02 Peania – Attiki,
Greece
Tel: +30-210-6686168

SWEDEN/FINLAND/ICELAND

**Yamaha Music Europe GmbH Germany Filial
Scandinavia**
JA Wettergrensgata 1, 400 43 Göteborg, Sweden
Tel: +46-31-89-34-00

DENMARK

**Yamaha Music Denmark,
Filial of Yamaha Music Europe GmbH, Tyskland**
Generatorvej 8C, ST. TH., 2860 Søborg, Denmark
Tel: +45-44-92-49-00

NORWAY

**Yamaha Music Europe GmbH Germany -
Norwegian Branch**
c/o Box 30053, 400 43 Göteborg, Sweden
Tel: +47-6716-7800

CYPRUS

Yamaha Music Europe GmbH
Siemensstrasse 22-34, 25462 Rellingen, Germany
Tel: +49-4101-303-0

RUSSIA

Yamaha Music (Russia) LLC.
Room 37, entrance 7, bld. 7, Kievskaya street,
Moscow, 121059, Russia
Tel: +7-495-626-5005

OTHER EUROPEAN REGIONS

Yamaha Music Europe GmbH
Siemensstrasse 22-34, 25462 Rellingen, Germany
Tel: +49-4101-3030

AFRICA

Yamaha Music Gulf FZE
JAFZA-16, Office 512, P.O.Box 17328,
Jebel Ali FZE, Dubai, UAE
Tel: +971-4-801-1500

MIDDLE EAST

TURKEY

Ertekin Elektronik tic. ve san. as
Kagithane Ofis ParkBaglar Cad.
No: 14 D/6 Kagithane 34406
ISTANBUL / TÜRKIYE
Tel: +90-212-312-24-24

OTHER REGIONS

Yamaha Music Gulf FZE
JAFZA-16, Office 512, P.O.Box 17328,
Jebel Ali FZE, Dubai, UAE
Tel: +971-4-801-1500

ASIA

MAINLAND CHINA

Yamaha Music & Electronics (China) Co.,Ltd.
2F, Yunhedasha, 1818 Xinzha-lu, Jingan-qu,
Shanghai, China
Tel: +86-400-051-7700

INDIA

Yamaha Music India Private Limited
P-401, JMD Megapolis, Sector-48, Sohna Road,
Gurugram-122018, Haryana, India
Tel: +91-124-485-3300

INDONESIA

PT Yamaha Musik Indonesia Distributor
Yamaha Music Center Bldg. Jalan Jend. Gatot
Subroto Kav. 4, Jakarta 12930, Indonesia
Tel: +62-21-520-2577

KOREA

Yamaha Music Korea Ltd.
11F, KB Life Tower, 298, Gangnam-daero,
Gangnam-gu, Seoul, 06253, Korea
Tel: +82-2-3467-3300

MALAYSIA

Yamaha Music (Malaysia) Sdn. Bhd.
No.8, Jalan Perbandaran, Kelana Jaya, 47301
Petaling Jaya, Selangor, Malaysia
Tel: +60-3-78030900

SINGAPORE

Yamaha Music (Asia) Private Limited
Block 202 Hougang Street 21, #02-00,
Singapore 530202, Singapore
Tel: +65-6740-9200

TAIWAN

Yamaha Music & Electronics Taiwan Co.,Ltd.
2F., No.1, Yuandong Rd., Banqiao Dist.,
New Taipei City 22063, Taiwan
Tel: +886-2-7741-8888

THAILAND

Siam Music Yamaha Co., Ltd.
3, 4, 15, 16th Fl., Siam Motors Building,
891/1 Rama 1 Road, Wangmai,
Pathumwan, Bangkok 10330, Thailand
Tel: +66-2215-2622

VIETNAM

Yamaha Music Vietnam Company Limited
15th Floor, Nam A Bank Tower, 201-203 Cach
Mang Thang Tam St., Ward 4, Dist.3,
Ho Chi Minh City, Vietnam
Tel: +84-8-3818-1122

OTHER ASIAN REGIONS

<http://asia.yamaha.com/>

OCEANIA

AUSTRALIA

Yamaha Music Australia Pty. Ltd.
Level 1, 80 Market Street, South Melbourne,
VIC 3205, Australia
Tel: +61-3-9693-5111

REGIONS AND TRUST TERRITORIES IN PACIFIC OCEAN

<http://asia.yamaha.com/>

Yamaha Pro Audio global website
<https://www.yamahaproaudio.com/>
Yamaha Downloads
<https://download.yamaha.com/>

© 2014 Yamaha Corporation
Published 01/2023
MWES-E1



VGQ0840