



PSR-S970

PSR-S770

Digital Workstation

Reference Manual

This Reference Manual explains advanced features of the PSR-S970/S770.
Please read the Owner's Manual first, before reading this Reference Manual.



EN

Table of Contents

Each chapter in this Reference Manual corresponds to the relevant chapters in the Owner's Manual.

1	Voices	3	7	Registration Memory	83
	Voice Types (Characteristics).....	3		Editing the Registration Memory.....	83
	Selecting GM&XG or Other Voices.....	5		Disabling Recall of Specific Items (Freeze).....	84
	Touch Response and Effect-Related Settings.....	6		Calling Up Registration Memory Numbers in Order (Registration Sequence).....	85
	Pitch-Related Settings.....	9	8	Microphone/Guitar Input	88
	Editing Parameters Assigned to the LIVE CONTROL Knobs.....	11		Making and Saving the Microphone/Guitar Settings (EQ/CMP).....	88
	Editing Voices (Voice Set).....	15		Setting and Editing Vocal Harmony Types (PSR-S970)...	91
	Editing Organ Flutes Voices.....	20		Editing the Synth Vocoder Types (PSR-S970).....	98
	Adding New Contents—Expansion Packs.....	22	9	Mixing Console	102
2	Styles	24		Editing VOL/VOICE Parameters.....	102
	Chord Fingering Types.....	25		Editing FILTER Parameters.....	103
	Style Playback Related Settings.....	27		Editing TUNE Parameters.....	104
	Memorizing Original Settings to One Touch Setting.....	29		Editing EFFECT Parameters.....	105
	Creating/Editing Styles (Style Creator).....	30		Editing EQ Parameters.....	109
3	Songs	49		Editing Master Compressor (CMP) Parameters.....	111
	Editing Music Notation (Score) Settings.....	49		Block Diagram.....	113
	Editing Lyrics/Text Display Settings.....	52	10	Connections	114
	Using the Auto Accompaniment Features with Song Playback.....	53		Footswitch/Foot Controller Settings.....	114
	Song Playback Related Parameters (Guide Function, Channel settings, Repeat settings).....	54		MIDI Settings.....	118
	Creating/Editing Songs (Song Creator).....	58		Connecting with an iPhone/iPad via Wireless LAN.....	124
4	USB Audio Player/Recorder	75	11	Other Functions	126
5	Multi Pads	75		UTILITY.....	126
	Creating Multi Pads (Multi Pad Creator).....	75		SYSTEM.....	130
	Editing Multi Pads.....	77	Index		133
6	Music Finder	79			
	Creating a Set of Favorite Records.....	79			
	Editing Records.....	80			
	Saving the Records as a Single File.....	81			

Using the PDF manual

- To quickly jump to items and topics of interest, click on the desired items in the “Bookmarks” index to the left of the main display window. (Click the “Bookmarks” tab to open the index if it is not displayed.)
- Click the page numbers that appear in this manual to go directly to the corresponding page.
- Select “Find” or “Search” from the Adobe Reader “Edit” menu and enter a keyword to locate related information anywhere in the document.

NOTE The names and positions of menu items may vary according to the version of Adobe Reader being used.

- The illustrations and LCD screens as shown in this manual are for instructional purposes only, and may appear somewhat different from those on your instrument.
- The displays are taken from the PSR-S970, and are in English.
- The “Data List” and “iPhone/iPad Connection Manual” documents can be downloaded from the Yamaha website: <http://download.yamaha.com/>
- The company names and product names in this manual are the trademarks or registered trademarks of their respective companies.

Contents

Voice Types (Characteristics)	3
Selecting GM&XG or Other Voices	5
Touch Response and Effect-Related Settings	6
• Setting the Touch Response of the Keyboard	6
• Making Detailed Settings for Harmony/Arpeggio	7
Pitch-Related Settings	9
• Fine-tuning the Pitch of the Entire Instrument	9
• Scale Tuning	9
• Changing the Part Assignment of the TRANSPOSE Buttons	10
Editing Parameters Assigned to the LIVE CONTROL Knobs	11
Editing Voices (Voice Set)	15
• Editable Parameters in the VOICE SET Displays	16
• Disabling Automatic Selection of Voice Sets (Effects, etc.)	19
Editing Organ Flutes Voices	20
Adding New Contents—Expansion Packs	22
• Installing the Expansion Pack data from the USB Flash Drive	22
• Uninstalling the Expansion Pack data	22
• Saving the Instrument Info File to the USB Flash Drive	23

Voice Types (Characteristics)

The particular type of Voice is indicated at the upper left of the Voice name in the Voice Selection display. The defining characteristics of these Voices and their performance advantages are described below.



S.Art! (Super Articulation)	<p>These Voices provide many benefits with great playability and expressive control in real time.</p> <p>For example, with the Saxophone Voice, if you play a C and then a D in a very legato way, you will hear the note change seamlessly, as though a saxophone player played it in a single breath.</p> <p>Similarly with the Concert Guitar Voice and play the D note strongly, the D note would sound as a “hammer on,” without the string being plucked again.</p> <p>Depending on how you play, other effects such as “shaking” or breath noises (for the Trumpet Voice), or finger noises (for the Guitar Voice) are produced.</p> <p>For details on how to best play each S.Art! Voice, call up the information window (pressing the [6 ▼] (INFO) button in the Voice Selection display).</p>
Live!	<p>These acoustic instrument sounds were sampled in stereo, to produce a truly authentic, rich sound—full of atmosphere and ambience.</p>
Cool!	<p>These Voices use sophisticated programming to capture the dynamic textures and subtle nuances of electric instruments.</p>
Sweet!	<p>These acoustic instrument sounds also benefit from Yamaha’s sophisticated technology—and feature a finely detailed and natural sound.</p>

Drums	Various drum and percussion sounds are assigned to individual keys, letting you play the sounds from the keyboard. For information about what sound is assigned to each key, refer to the “Drum/SFX Kit List” in the Data List on the website.
Live! Drums	These are high-quality drum sounds that take full advantage of Stereo Sampling and Dynamic Sampling.
SFX	Various special effect sounds and percussion sounds are assigned to individual keys, letting you play the sounds from the keyboard. For information about what sound is assigned to each key, refer to the “Drum/SFX Kit List” in the Data List on the website.
Live! SFX	These are various high-quality special effect sounds and percussion sounds that take full advantage of Stereo Sampling and Dynamic sampling.
Organ Flutes!	This authentic organ Voice lets you use the Voice Set to adjust the various footages and craft your own original organ sounds. See page 20 for details.
MegaVoice	<p>These Voices make special use of velocity switching. Each velocity range (the measure of your playing strength) has a completely different sound. For example, a guitar MegaVoice includes the sounds of various performance techniques. In conventional instruments, different Voices having those sounds would be called up via MIDI and played in combination to achieve the desired effect. However, now with MegaVoices, a convincing guitar part can be played with just a single Voice, using specific velocity values to play the desired sounds. Because of the complex nature of these Voices and the precise velocities need to play the sounds, they’re not intended for playing from the keyboard. They are, however, very useful and convenient when creating MIDI data—especially when you want to avoid using several different Voices just for a single instrument part.</p> <p>The MegaVoices are in the “MegaVoices” folder in the Voice Selection display. For instructions on selecting MegaVoices, refer to the “Selecting GM&XG or Other Voices” on page 5.</p>

NOTE S.Art! and MegaVoices are not compatible with other instrument models. For this reason, any Song or Style you’ve created on this instrument using these Voices will not sound properly when played back on the instruments which do not have these types of Voices.

NOTE S.Art! and MegaVoices sound differently depending on keyboard range, velocity, touch, etc. Hence, if you turn on the [HARMONY/ARPEGGIO] button, change the transpose setting or change the Voice Set parameters, unexpected or undesired sounds may result.

For a list of preset Voices of this instrument, refer to the “Voice List” in the Data List on the website.

Selecting GM&XG or Other Voices

This instrument features Voices provided specially for Style playback and XG/GM compatibility. These Voices cannot be called up directly from the VOICE category selection buttons. However, they can be called up as described below.

- 1 Turn on the **PART SELECT** button corresponding to the part you want to use.
- 2 Press one of the **VOICE** category selection buttons (other than the [ORGAN FLUTES] and [EXPANSION/USER] buttons) to call up the Voice Selection display.
- 3 Press the [8 ▲] (UP) button to call up the Voice categories.

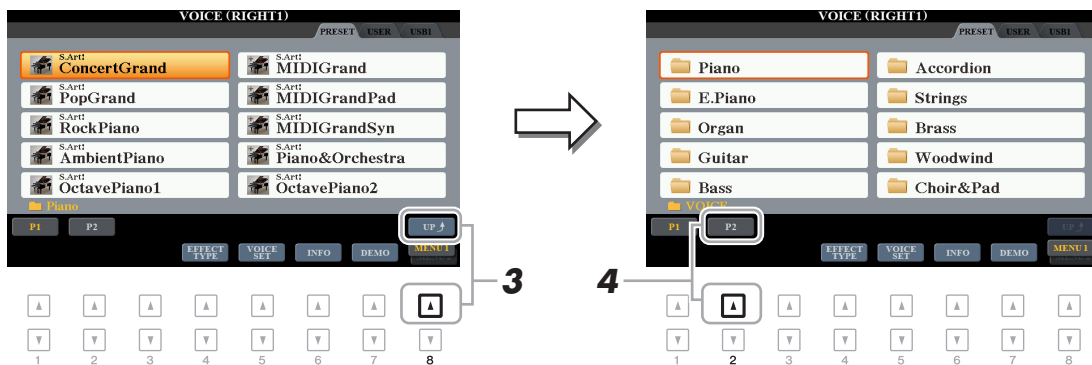

- 4 Press the [2 ▲] (P2) button to display page 2.
- 5 Press the desired [A]–[J] button to call up the Voice Selection display of GM&XG Voices, GM2 Voices, etc.

NOTE You can find the "Legacy" folder in this display. This folder contains previous Yamaha keyboards' Voices (such as PSR-S950, PSR-S750, etc.) for data compatibility with other models.

NOTE The "MegaVoices" folder contains the MegaVoices (page 4).

- 6 Select the desired Voice.

Touch Response and Effect-Related Settings

Setting the Touch Response of the Keyboard

Touch Response determines how the sound responds to your playing strength. The selected Touch Response type becomes the common setting for all Voices.

NOTE Some Voices are purposely designed without Touch Response, in order to emulate the true characteristics of the actual instrument (for example, conventional organs, which have no touch response).

1 Call up the operation display.

[FUNCTION] → TAB [◀] MENU 1 → [D] CONTROLLER → TAB [▶] KEYBOARD/PANEL

2 Use the [A] button to select “1 TOUCH RESPONSE.”

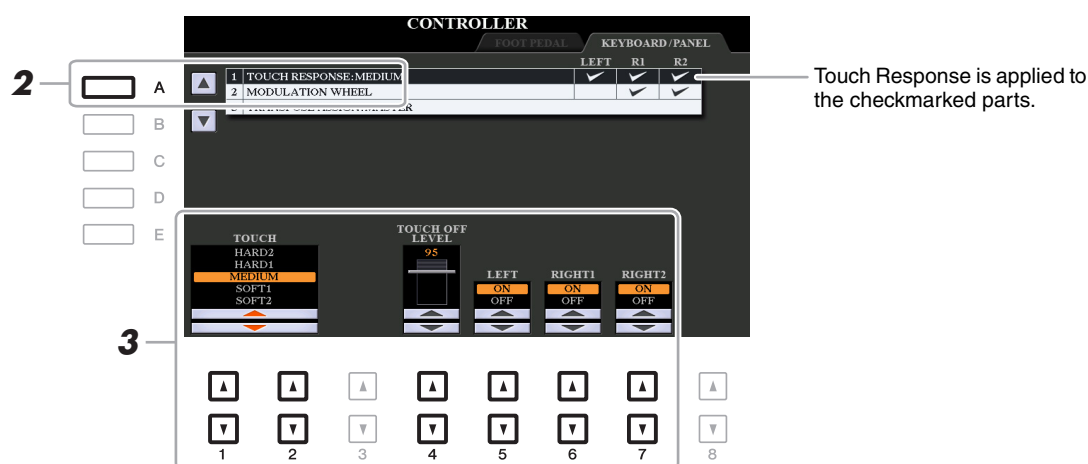

3 Use the [1 ▲▼], [2 ▲▼] and [4 ▲▼]–[7 ▲▼] buttons to set the Touch Response.

[1 ▲▼]/ [2 ▲▼]	TOUCH	Determines the Touch Response type. HARD 2: Requires strong playing to produce high volume. Best for players with a heavy touch. HARD 1: Requires moderately strong playing for higher volume. MEDIUM: Standard Touch Response. SOFT 1: Produces high volume with moderate playing strength. SOFT 2: Produces relatively high volume even with light playing strength. Best for players with a light touch.
[4 ▲▼]	TOUCH OFF LEVEL	Determines the fixed volume level when Touch is set to “OFF.”
[5 ▲▼]– [7 ▲▼]	LEFT–RIGHT2	Turns Touch on or off for each keyboard part.

Making Detailed Settings for Harmony/Arpeggio

This lets you make detailed settings, including volume level.

1 Call up the operation display.

[FUNCTION] → TAB [◀] MENU 1 → [B] HARMONY/ARPEGGIO

2 Select the desired Harmony/Arpeggio category and type by using the [1 ▲▼]–[6 ▲▼] buttons.



3 Use the [7 ▲▼] (DETAIL) buttons to call up the detailed setting window.

4 Use the [3 ▲▼]–[8 ▲▼] buttons to make various Harmony/Arpeggio settings.

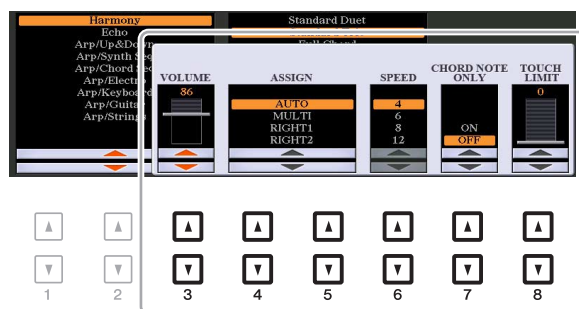

When any one of the Arpeggio types is selected, only the parameters indicated by “*” in the list below can be set. None of the parameters in the list below are available when the Harmony category “Multi Assign” type is selected.

[3 ▲▼]	VOLUME*	Determines the volume level of the Harmony/Arpeggio notes generated by the Harmony/Arpeggio function. NOTE When you are using certain Voices, such as Organ Voices, in which the TOUCH SENSE DEPTH is set to 0 in the VOICE SET display (page 16), the volume does not change.
[4 ▲▼]/ [5 ▲▼]	ASSIGN*	Determines the keyboard part to which the effect is assigned. AUTO: Applies the effect to the part (RIGHT 1/2) for which PART ON/OFF is on. If the Harmony/Echo category is selected, the RIGHT 1 part is given priority over the RIGHT 2 part when both parts are on. MULTI: This parameter is available when the Harmony/Echo category is selected. When both parts are on, the note played on the keyboard is sounded by the RIGHT 1 part and the harmonies (effect) are divided to the RIGHT 1 and RIGHT 2 parts. When only one part is on, the note played on the keyboard and effect are sounded by that part. RIGHT 1, RIGHT 2: Applies the effect to the selected part (RIGHT 1 or RIGHT 2).

[6 ▲▼]	SPEED	This parameter is only available when the “Echo” category (Echo, Tremolo, or Trill) is selected. It determines the speed of the Echo, Tremolo, and Trill effects.
[7 ▲▼]	CHORD NOTE ONLY	This parameter is only available when the “Harmony” category is selected. When this is set to “ON,” the Harmony effect is applied only to the note (played in the right-hand section of the keyboard) that belongs to a chord played in the chord section of the keyboard.
[8 ▲▼]	TOUCH LIMIT	It determines the lowest velocity value at which the Harmony, Echo, Tremolo, or Trill note will sound. This allows you to selectively apply the harmony by your playing strength, letting you create harmony accents in the melody. The harmony effect is applied when you play the key strongly (above the set value).

NOTE The settings for the Arpeggio Quantize function and the Arpeggio Hold function can be made on the display called up via [FUNCTION] → TAB [◀] MENU 1 → [J] UTILITY → TAB [◀][▶] CONFIG 2 (page 128).

Pitch-Related Settings

Fine-tuning the Pitch of the Entire Instrument

You can fine-tune the pitch of the entire instrument such as keyboard, Style and Song parts (except the keyboard part played by the Drum Kit or SFX Kit Voices, and audio playback)—a useful feature when playing the PSR-S970/S770 along with other instruments or CD music.

1 Call up the operation display.

[FUNCTION] → TAB [◀] MENU 1 → [E] MASTER TUNE/SCALE TUNE → TAB [◀] MASTER TUNE

2 Use the [4 ▲▼]/[5 ▲▼] buttons to set the tuning in 0.2 Hz steps.

Press both [▲] and [▼] buttons (of 4 or 5) simultaneously to reset the value to the factory setting of 440.0 Hz.

Scale Tuning

You can select various scales for playing in custom tunings for specific historical periods or music genres.

1 Call up the operation display.

[FUNCTION] → TAB [◀] MENU 1 → [E] MASTER TUNE/SCALE TUNE → TAB [▶] SCALE TUNE

2 Use the [A]/[B] buttons to select the desired scale.

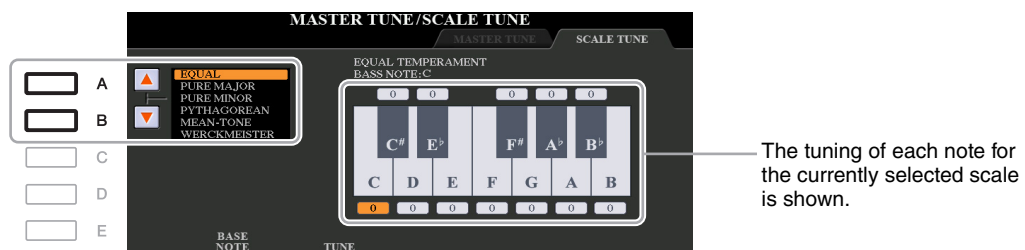

■ Preset Scale types

EQUAL	The pitch range of each octave is divided equally into twelve parts, with each half-step evenly spaced in pitch. This is the most commonly used tuning in music today.
PURE MAJOR, PURE MINOR	These tunings preserve the pure mathematical intervals of each scale, especially for triad chords (root, third, fifth). You can hear this best in actual vocal harmonies—such as choirs and a cappella singing.
PYTHAGOREAN	This scale was devised by the famous Greek philosopher and is created from a series of perfect fifths, which are collapsed into a single octave. The 3rd in this tuning are slightly unstable, but the 4th and 5th are beautiful and suitable for some leads.
MEAN-TONE	This scale was created as an improvement on the Pythagorean scale, by making the major third interval more “in tune.” It was especially popular from the 16th century to the 18th century. Handel, among others, used this scale.
WERCKMEISTER, KIRNBERGER	This composite scale combines the Werckmeister and Kirnberger systems, which were themselves improvements on the mean-tone and Pythagorean scales. The main feature of this scale is that each key has its own unique character. The scale was used extensively during the time of Bach and Beethoven, and even now it is often used when performing period music on the harpsichord.
ARABIC1, ARABIC2	Use these tunings when playing Arabic music.

3 Change the following settings as necessary.

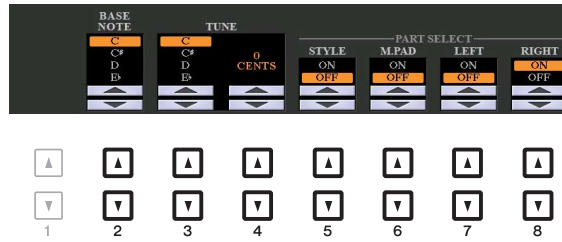

[2 ▲▼]	BASE NOTE	Determines the base note for each scale. When the base note is changed, the pitch of the keyboard is transposed, yet maintains the original pitch relationship between the notes.
[3 ▲▼]/ [4 ▲▼]	TUNE	Select the desired note to be tuned by using the [3 ▲▼] buttons and tune it in cents by using the [4 ▲▼] buttons. NOTE In musical terms a “cent” is 1/100th of a semitone. (100 cents equal one semitone.)
[5 ▲▼]- [8 ▲▼]	PART SELECT	Determines whether the Scale Tune setting is applied to each part or not.

NOTE To register the Scale Tune settings to Registration Memory, be sure to checkmark the SCALE item in the REGISTRATION MEMORY CONTENTS display called up via the [MEMORY] button.

Changing the Part Assignment of the TRANSPOSE Buttons

You can determine to which parts the TRANSPOSE [-]/[+] buttons are applied.

1 Call up the operation display.

[FUNCTION] → TAB [◀] MENU 1 → [D] CONTROLLER → TAB [▶] KEYBOARD/PANEL

2 Use the [B] button to select “3 TRANSPOSE ASSIGN.”

3 Press the [4 ▲▼]/[5 ▲▼] buttons to select the desired part assignment.

KEYBOARD	The TRANSPOSE [-]/[+] buttons affect the pitch of keyboard played Voices, Style playback (controlled by the performance in the chord section of the keyboard), and Multi Pad playback (when Chord Match is on, and left-hand chords are indicated)—but they do not affect Song playback.
SONG	The TRANSPOSE [-]/[+] buttons affect only the pitch of Song playback.
MASTER	The TRANSPOSE [-]/[+] buttons affect the overall pitch of the instrument, except audio playback.

The assignment can be confirmed by the pop-up display called up via the TRANSPOSE [-]/[+] buttons.



Editing Parameters Assigned to the LIVE CONTROL Knobs

The eight combinations of functions assigned to the LIVE CONTROL knobs are provided by default, however, you can change the functions as desired from a variety of options.

- 1 Press the [ASSIGN] button to call up the LIVE CONTROL display.

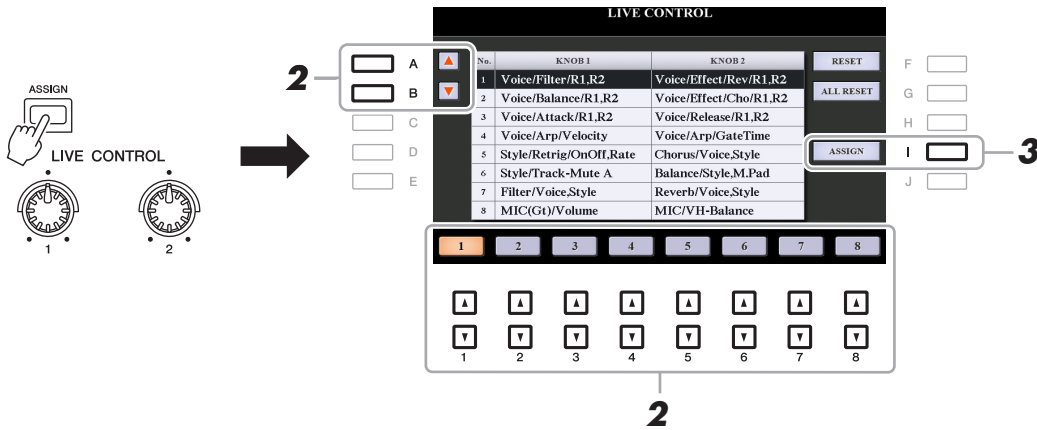

- 2 Use the [A]/[B] buttons or the [1 ▲▼]–[8 ▲▼] buttons to select the number of the functions you want to change.
- 3 Press the [I] (ASSIGN) button to call up the PARAMETER ASSIGN window.

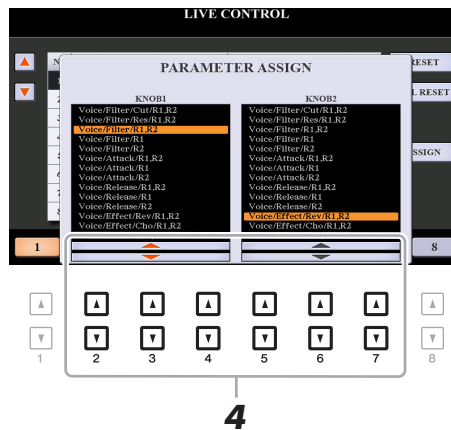

- 4 Use the [2 ▲▼]–[4 ▲▼] buttons (for knob 1) and the [5 ▲▼]–[7 ▲▼] buttons (for knob 2) to select the functions to be assigned.
For information on available functions, see [pages 12–14](#).
- 5 Press the [EXIT] button to close the PARAMETER ASSIGN window.
- 6 If necessary, repeat steps 2–5 to change the functions for other numbers.

NOTE The settings here are maintained even when you turn off the power.

NOTE Depending on the panel settings or how you move the knob, you may not notice any change to the parameter value, or the knob may not work as expected, even if you rotate it.

■ Assignable Knob Functions

Voice/Filter/Cut/R1,R2	Adjusts the cutoff frequency of the filter for the RIGHT 1 and 2 parts. Rotating the knob to the right makes the sound brighter.
Voice/Filter/Res/R1,R2	Adjusts the resonance of the filter for the RIGHT 1 and 2 parts. Rotating the knob to the right makes the sound more pronounced.
Voice/Filter/R1,R2	Adjusts the cutoff frequency of the filter and the resonance for the RIGHT 1 and/or 2 parts to change the timbre or tone of the sound.
Voice/Filter/R1	
Voice/Filter/R2	
Voice/Attack/R1,R2	Adjusts the length of time until the RIGHT 1 and/or 2 parts reach their maximum level after the key is played. Rotating the knob to the right increases it.
Voice/Attack/R1	
Voice/Attack/R2	
Voice/Release/R1,R2	Adjusts the length of time until the RIGHT 1 and/or 2 parts decay to silence after the key is released. Rotating the knob to the right increases it.
Voice/Release/R1	
Voice/Release/R2	
Voice/Effect/Rev/R1,R2	Adjusts the Reverb depth for the RIGHT 1 and 2 parts. Rotating the knob to the right makes it deeper.
Voice/Effect/Cho/R1,R2	Adjusts the Chorus depth for the RIGHT 1 and 2 parts. Rotating the knob to the right makes it deeper.
Voice/Effect/Rev,Cho/R1	Adjusts both the Reverb depth and Chorus depth for the RIGHT 1 or 2 part. Rotating the knob to the right makes it deeper.
Voice/Effect/Rev,Cho/R2	
Voice/Balance/R1,R2	Adjusts the volume balance between the RIGHT 1 and 2 parts. Rotating the knob to the left increases the RIGHT 1 volume, while rotating it to the right increases the RIGHT 2 volume.
Voice/Arp/Velocity	Adjusts the volume of Arpeggio. Rotating the knob to the right increases it.
Voice/Arp/GateTime	Adjusts the length of each note of Arpeggio. Rotating the knob to the right increases it.
Voice/Arp/UnitMultiply	Adjust the speed of Arpeggio. Rotating the knob to the right makes it faster.
Style/Filter/Cutoff	Adjusts the cutoff frequency of the filter for the Style. Rotating the knob to the right makes the sound brighter.
Style/Filter/Resonance	Adjusts the resonance of the filter for the Style. Rotating the knob to the right makes the sound more pronounced.
Style/Filter/Cutoff,Res	Adjusts the cutoff frequency of the filter and the resonance for the Style to change the timbre or tone of the sound.
Style/Effect/Reverb	Adjusts the Reverb depth for the Style. Rotating the knob to the right makes it deeper.
Style/Effect/Chorus	Adjusts the Chorus depth for the Style. Rotating the knob to the right makes it deeper.
Style/Effect/Rev,Cho	Adjusts both the Reverb and Chorus depth for the Style. Rotating the knob to the right makes it deeper.

Style/Retrig/Rate	Adjusts the Style Retrigger length. The first part of the current Style is repeated in the specified length. Rotating the knob to the right decreases it.
Style/Retrig/OnOff	Turns the Style Retrigger function on/off. Rotating the knob to the right turns it on, while rotating it to the left turns it off.
Style/Retrig/OnOff,Rate	Turns the Style Retrigger function on/off and adjusts its length. Rotating the knob to the left-most turns the function off; rotating it to the right turns the function on and decreases the length.
Style/Track-Mute A	Turns playback of the Style channels on/off. Rotating the knob to the left-most position turns on only the Rhythm 2 channel, and the other channels are turned off. By rotating the knob clockwise from that position, channels are turned on in the order of Rhythm 1, Bass, Chord 1, Chord 2, Pad, Phrase 1, Phrase 2, and all channels are turned on when the knob reaches to the right-most position. Turning the channels on/off lets you easily change the rhythmic feel.
Style/Track-Mute B	Turns playback of the Style channels on/off. Rotating the knob to the left-most position turns on only the Chord 1 channel, and the other channels are turned off. By rotating the knob clockwise from that position, channels are turned on in the order of Chord 2, Pad, Bass, Phrase 1, Phrase 2, Rhythm 1, Rhythm 2, and all channels are turned on when the knob reaches to the right-most position. Turning on/off the channels lets you easily change the rhythmic feel.
MIC(Gt)/Effect/Reverb	Adjusts the Reverb depth for the microphone or the guitar input sound. Rotating the knob to the right makes it deeper.
MIC(Gt)/Effect/Chorus	Adjusts the Chorus depth for the microphone or the guitar input sound. Rotating the knob to the right makes it deeper.
MIC(Gt)/Effect/DSP	Adjusts the DSP effect depth for the microphone or the guitar input sound. Rotating the knob to the right makes it deeper. NOTE Depending on the selected DSP type or how the microphone or the guitar is connected, the sound may not be changed.
MIC(Gt)/Volume	Adjusts the volume of the microphone or guitar sound input from the [MIC/GUITAR INPUT] jack. Rotating the knob to the right increases it.
MIC/VH-Balance (PSR-S970)	Adjusts the volume balance between the lead vocal (your own voice) and Vocal Harmony. Rotating the knob to the left increases the lead vocal volume, while rotating it to the right increases the Vocal Harmony volume.
Audio/Volume	Controls the Audio playback volume. As you rotate the knob to the right, it increases.
AUX/Volume	Controls the input volume from the [AUX IN] jack. Rotating the knob to the right increases it.
Balance/Voice,Style	Adjusts the volume balance between the Voice and Style playback. Rotating the knob to the left increases the Style volume, while rotating it to the right increases the Voice volume.
Balance/Style,M.Pad	Adjusts the volume balance between the Style and Multi Pad playback. Rotating the knob to the left increases the Style volume, while rotating it to the right increases the Multi Pad volume.
Balance/Audio,AUX	Adjusts the volume balance between the Audio playback and sound input from the [AUX IN] jack. Rotating the knob to the left increases the Audio playback volume, while rotating it to the right increases the input volume from the [AUX IN] jack.

Balance/Song,Audio	Adjusts the volume balance between the Song and Audio playback. Rotating the knob to the left increases the Song volume, while rotating it to the right increases the Audio (USB Audio Player) volume.
Balance/Song,AUX	Adjusts the volume balance between the Song playback and sound input from the [AUX IN] jack. Rotating the knob to the left increases the Song playback volume, while rotating it to the right increases the input volume from the [AUX IN] jack.
Balance/MIDI,AudioAUX	Adjusts the volume balance between the playback of MIDI data (Song, Style, Multi Pad) and Audio (USB Audio Player and input from the [AUX IN] jack). Rotating the knob to the left increases the MIDI volume, while rotating it to the right increases the Audio volume.
Filter/Voice,Style	Adjusts the cutoff frequency of the filter and the resonance for all keyboard parts and the Style to change the timbre or tone of the sound.
Reverb/Voice,Style	Adjusts the Reverb depth for all keyboard parts and the Style. Rotating the knob to the right makes it deeper.
Chorus/Voice,Style	Adjusts the Chorus depth for all keyboard parts and the Style. Rotating the knob to the right makes it deeper.
Master Tempo	Changes the tempo of the currently selected Style or Song. Rotating the knob to the left makes it slower, while rotating it to the right makes it faster. Setting range is from 50% of the default tempo value to 150%.
<No Assign>	No function is assigned.

Editing Voices (Voice Set)

The Voice Set function allows you to create your own Voices by editing some parameters of the existing Voices. Once you've created a Voice, you can save it as a file to internal memory (USER drive) or a USB flash drive for future recall.

1 Select the desired Voice (other than an Organ Flutes Voice).

Organ Flutes Voices have a different editing method than described here. For instructions on editing the Organ Flutes Voices, see [page 20](#).

2 In the Voice Selection display, press the [5 ▼] (VOICE SET) button of MENU 1 to call up the VOICE SET display.

3 Use the TAB [◀][▶] buttons to call up the relevant setting page.

For information on the available parameters in each page, see the “Editable Parameters in the VOICE SET Displays” on [page 16](#).

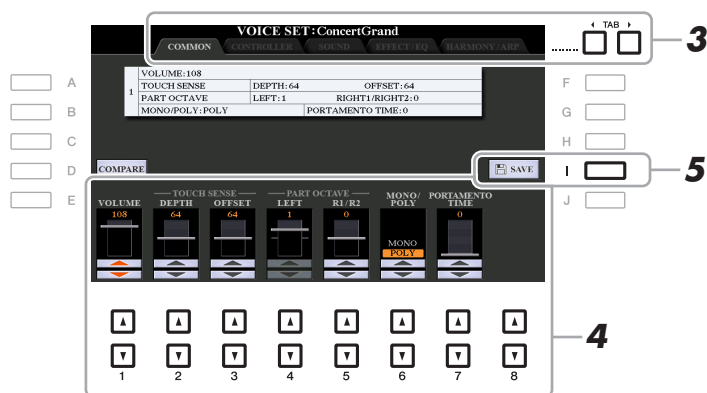

4 As necessary, use the [A]/[B] buttons to select the item (parameter) to be edited and edit the Voice by using the [1 ▲▼]–[8 ▲▼] buttons.

By pressing the [D] (COMPARE) button, you can compare the sound of the edited Voice with the original (unedited) Voice.

5 Press the [I] (SAVE) button to save your edited Voice.

For details on the Save operation, refer to “Basic Operations” in the Owner’s Manual.

NOTICE

The settings will be lost if you select another Voice or turn off the power to the instrument without carrying out the Save operation.



Editable Parameters in the VOICE SET Displays

The Voice Set parameters are organized into five different pages. The parameters in each page are described separately, below.

NOTE The available parameters differ depending on the Voice.

COMMON Page

[1 ▲▼]	VOLUME	Adjusts the volume of the current edited Voice.
[2 ▲▼]/ [3 ▲▼]	TOUCH SENSE	<p>Adjusts the touch sensitivity (velocity sensitivity), or how greatly the volume responds to your playing strength.</p> <div style="display: flex; justify-content: space-around;"> <div style="width: 45%;"> <p>TOUCH SENSE DEPTH Changes to velocity curve according to VelDepth (with Offset set to 64)</p> <p>Actual Velocity for tone generator</p> </div> <div style="width: 45%;"> <p>TOUCH SENSE OFFSET Changes to velocity curve according to VelOffset (with Depth set to 64)</p> <p>Actual Velocity for tone generator</p> </div> </div> <p>DEPTH: Determines the velocity sensitivity, or how much the level of the Voice changes in response to your playing strength (velocity).</p> <p>OFFSET: Determines the amount by which received velocities are adjusted for the actual velocity effect.</p>
[4 ▲▼]/ [5 ▲▼]	PART OCTAVE	Shifts the octave range of the edited Voice up or down in octaves. When the edited Voice is used as any of the RIGHT 1–2 parts, the R1/R2 parameter is available; when the edited Voice is used as the LEFT part, the LEFT parameter is available.
[6 ▲▼]	MONO/POLY	Determines whether the edited Voice is played monophonically or polyphonically. This setting can also be made from the VOICE EFFECT [MONO] button on the panel.
[7 ▲▼]	PORTAMENTO TIME	<p>Determines the pitch transition time when the edited Voice is set to MONO above.</p> <p>NOTE Portamento is a function that creates a smooth transition in pitch from the first note played on the keyboard to the next.</p>



■ CONTROLLER Page

MODULATION

The [MODULATION] wheel can be used to modulate the parameters below as well as the pitch (vibrato). Here, you can set the degree to which the [MODULATION] wheel modulates each of the following parameters.

[2 ▲▼]	FILTER	Determines the degree to which the [MODULATION] wheel modulates the Filter Cutoff Frequency. For details about the filter, see below.
[3 ▲▼]	AMPLITUDE	Determines the degree to which the [MODULATION] wheel modulates the amplitude (volume).
[5 ▲▼]	LFO PMOD	Determines the degree to which the [MODULATION] wheel modulates the pitch, or the vibrato effect.
[6 ▲▼]	LFO FMOD	Determines the degree to which the [MODULATION] wheel modulates the Filter modulation, or the wah effect.
[7 ▲▼]	LFO AMOD	Determines the degree to which the [MODULATION] wheel modulates the amplitude, or the tremolo effect.

■ SOUND Page

FILTER

Filter is a processor that changes the timbre or tone of a sound by either blocking or passing a specific frequency range. The parameters below determine the overall timbre of the sound by boosting or cutting a certain frequency range. In addition to making the sound either brighter or mellower, Filter can be used to produce electronic, synthesizer-like effects.

[1 ▲▼]	BRIGHT. (Brightness)	Determines the cutoff frequency or effective frequency range of the filter (see diagram). Higher values result in a brighter sound.	
[2 ▲▼]	HARMO. (Harmonic Content)	Determines the emphasis given to the cutoff frequency (resonance), set in BRIGHT. above (see diagram). Higher values result in a more pronounced effect.	

EG

The EG (Envelope Generator) settings determine how the level of the sound changes in time. This lets you reproduce many sound characteristics of natural acoustic instruments—such as the quick attack and decay of percussion sounds, or the long release of a sustained piano tone.

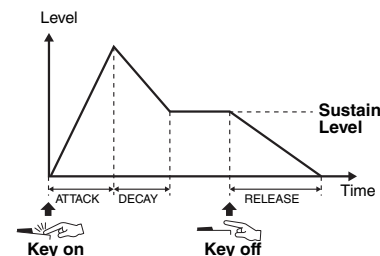

[3 ▲▼]	ATTACK	Determines how quickly the sound reaches its maximum level after the key is played. The lower the value, the quicker the attack.
[4 ▲▼]	DECAY	Determines how quickly the sound reaches its sustain level (a slightly lower level than maximum). The lower the value, the quicker the decay.
[5 ▲▼]	RELEASE	Determines how quickly the sound decays to silence after the key is released. The lower the value, the quicker the decay.

VIBRATO

Vibrato is a quavering, vibrating sound effect that is produced by regularly modulating the pitch of the Voice.

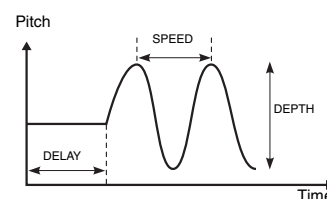

[6 ▲▼]	DEPTH	Determines the intensity of the Vibrato effect. Higher settings result in a more pronounced Vibrato.
[7 ▲▼]	SPEED	Determines the speed of the Vibrato effect.
[8 ▲▼]	DELAY	Determines the amount of time that elapses between the playing of a key and the start of the Vibrato effect. Higher settings increase the delay of the Vibrato onset.

■ EFFECT/EQ Page**1 REVERB DEPTH/CHORUS DEPTH/DSP DEPTH/PANEL SUSTAIN**

[1 ▲▼]/ [2 ▲▼]	REVERB DEPTH	Adjusts the reverb depth.
[3 ▲▼]/ [4 ▲▼]	CHORUS DEPTH	Adjusts the chorus depth.
[5 ▲▼]	DSP ON/OFF	Determines whether the DSP effect is on or off. This setting can also be made from the VOICE EFFECT [DSP] button on the panel.
[6 ▲▼]	DSP DEPTH	Adjusts the DSP depth. If you want to re-select the DSP type, you can do so in the “2 DSP” menu explained on page 19 .
[7 ▲▼]	PANEL SUSTAIN	Determines the sustain level applied to the edited Voice when the VOICE EFFECT [SUSTAIN] button on the panel is turned on.

2 DSP

[1 ▲▼]/ [2 ▲▼]	CATEGORY	Selects the DSP effect category and type. Select a type after selecting a category.
[3 ▲▼]/ [4 ▲▼]	TYPE	
[6 ▲▼]	VARIATION ON/OFF	Turns the DSP Variation on or off for the selected Voice. This setting can also be made from the VOICE EFFECT [DSP VARI.] button on the panel.
[5 ▲▼]/ [7 ▲▼]	DETAIL	Calls up a detailed setting display. Press the [5 ▲▼] button for editing the standard parameter value, and the [7 ▲▼] button for editing the Variation parameter value.
[2 ▲▼] -[4 ▲▼]	PARAMETER	Selects the DSP variation parameter to be set.
[5 ▲▼] -[6 ▲▼]	VALUE	Adjusts the value of the DSP variation parameter.

3 EQ

Determines the Frequency and Gain of the low and high EQ bands. Use the [2 ▲▼]–[4 ▲▼] buttons for the low EQ band, and the [5 ▲▼]–[7 ▲▼] buttons for the high EQ band.

■ HARMONY/ARP Page

Same as the display called up via [FUNCTION] → TAB [◀] MENU 1 → [B] HARMONY/ARPEGGIO (pages 7–8), with the exception of the following points:

- The details set via the [7 ▲▼] (DETAIL) buttons are shown on the top of the display.
- The [D] (COMPARE) and [I] (SAVE) buttons are available (see steps 4–5 on page 15).

Disabling Automatic Selection of Voice Sets (Effects, etc.)

Each Voice is linked to its default VOICE SET parameter settings. Usually these settings are automatically called up when a Voice is selected. However, you can also disable this feature by the operation in the relevant display as explained below. For example, if you want to change the Voice yet keep the same effect, set the EFFECT parameter to OFF (in the display explained below).

1 Call up the operation display.

[FUNCTION] → TAB [◀] MENU 1 → [F] VOICE SET FILTER

2 Use the [A]/[B] buttons to select a keyboard part.

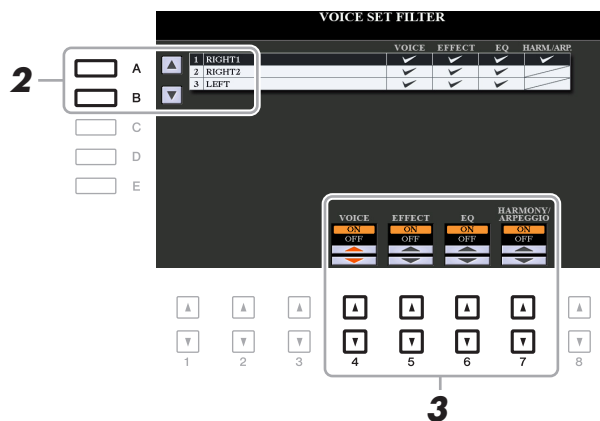

3 Use the [4 ▲▼]–[7 ▲▼] buttons to turn each item for the selected Part on or off.

When the button is set to ON, the corresponding parameter settings are called up automatically together with the Voice selection. For information on which parameters are linked to each item, see below.

[4 ▲▼]	VOICE	Corresponds to the parameter settings of the COMMON, CONTROLLER, and SOUND pages.
[5 ▲▼]	EFFECT	Corresponds to the parameter settings of 1 and 2 in the EFFECT/EQ page.
[6 ▲▼]	EQ	Corresponds to the parameter settings of 3 in the EFFECT/EQ page.
[7 ▲▼]	HARMONY/ ARPEGGIO	Corresponds to the HARMONY/ARP page.

Editing Organ Flutes Voices

The Organ Flute Voices can be edited by adjusting the footage levers, adding the attack sound, applying effects and equalizer, etc.

1 Select the desired Organ Flutes Voice.

- 1-1 Press the [ORGAN FLUTES] button.
- 1-2 Press the [I] (PRESET) button to call up the Voice Selection display.
- 1-3 Press one of the [A]–[J] buttons to select the desired Voice.

2 Press the [5 ▼] (VOICE SET) button to call up the VOICE SET display.

3 Use the TAB [◀][▶] buttons to call up the relevant setting page (FOOTAGE, VOLUME/ATTACK or EFFECT/EQ).

For information on the available parameters in each page, see [pages 20–21](#).

4 Edit the Organ Flutes Voice.

5 Press the [I] (PRESET) button to call up the Organ Flutes Voice Selection display.

6 Save your edited Voice.

For instructions on the Save operation, refer to “Basic Operations” in the Owner’s Manual.

NOTICE

The settings will be lost if you select another Voice or turn off the power to the instrument without carrying out the Save operation.

■ FOOTAGE Page

Refer to the Owner’s Manual, chapter 1.



NEXT PAGE

■ VOLUME/ATTACK Page



Same as the FOOTAGE page.

[1 ▲▼]	VOLUME	Adjusts the overall volume of the Organ Flutes. The longer the graphic bar, the greater the volume.
[2 ▲▼]	RESP. (Response)	Affects both the attack and release (page 18) portion of the sound, increasing or decreasing the response time of the initial swell and release, based on the FOOTAGE controls. The higher the value, the slower the swell and release.
[3 ▲▼]	VIBRATO SPEED	Determines the speed of the vibrato effect controlled by the Vibrato On/Off ([F]/[G] buttons) and Vibrato Depth ([H] button).
[4 ▲▼]	MODE	The MODE control selects between two modes: FIRST and EACH. In the FIRST mode, attack (percussive sound) is applied only to the first notes played and held simultaneously; while the first notes are held, any subsequently played notes have no attack applied. In the EACH mode, attack is applied equally to all notes.
[5 ▲▼]– [7 ▲▼]	4', 2 2/3', 2'	These determine the attack sound volume of the Organ Flutes Voice. The 4', 2-2/3' and 2' controls increase or reduce the volume of attack sound at the corresponding footages. The longer the graphic bar, the greater the attack sound volume.
[8 ▲▼]	LENGTH	Affects the attack portion of the sound producing a longer or shorter decay immediately after the initial attack. The longer the graphic bar, the longer the decay.

■ EFFECT/EQ Page

Same parameters as in the VOICE SET “EFFECT/EQ” page explained on [page 18](#), except that PANEL SUSTAIN is not available for the Organ Flutes Voices.

Adding New Contents—Expansion Packs

Installing Expansion Packs lets you add a variety of optional Voices and Styles to the “Expansion” folder in the USER drive. This section covers the operations which may be necessary to add new contents to the instrument.

Installing the Expansion Pack data from the USB Flash Drive

The file which contains the bundled Expansion Packs (“***.ppi” or “***.cpi”) to be installed to the instrument is referred to as “Pack Installation file.” Only one Pack Installation file can be installed to the instrument. If you want to install multiple Expansion Packs, bundle the packs together on your computer by using the “Yamaha Expansion Manager” software. For information on how to use the software, refer to the accompanying manual.

NOTICE

You will need to restart the instrument after installation has been completed. Make sure to save all data currently being edited beforehand, otherwise it will be lost.

- 1** Connect the USB flash drive in which the desired Pack Installation file (“***.ppi” or “***.cpi”) is saved to the [USB TO DEVICE] terminal.
- 2** Call up the operation display.
[FUNCTION] → TAB [▶] MENU 2 → [F] PACK INSTALLATION
- 3** Use the [A]–[J] buttons to select the desired Pack Installation file.
- 4** Press the [6 ▼] (INSTALL) button.
- 5** Follow the on-display instructions.

This installs the selected Pack data to the “Expansion” folder in the USER drive.

Song, Style or Registration Memory containing Expansion Voices or Styles

Song, Style or Registration Memory containing any Expansion Voices or Styles will not sound properly or cannot be called up, if the Expansion Pack data does not exist in the instrument.

We recommend that you write down the name of the Expansion Pack when you create the data (Song, Style or Registration Memory) using Expansion Voices or Styles, so that you can easily find and install the Expansion Pack when necessary.

Uninstalling the Expansion Pack data

You can uninstall the Expansion Pack data by carrying out the Reset operation for FILES & FOLDERS (see [page 132](#)).

NOTICE

When you reset FILES & FOLDERS, not only the Expansion Pack data, but all other files and folders in the USER drive are deleted.

Saving the Instrument Info File to the USB Flash Drive

If you use the “Yamaha Expansion Manager” software to manage the Pack data, you may need to retrieve the Instrument Info file from the instrument as described below. For information on how to use the software, refer to the accompanying manual.

1 Connect the USB flash memory to the [USB TO DEVICE] terminal.

NOTE Before using a USB flash drive, be sure to read “Connecting USB Devices” in the Owner’s Manual, chapter 10.

2 Call up the operation display.

[FUNCTION] → TAB [▶] MENU 2 → [G] SYSTEM → TAB [◀] OWNER



3 Press the [D] (EXPORT INSTRUMENT INFO) button.

4 Follow the on-display instructions.

This saves the Instrument Info file to the root directory in the USB flash drive. The saved file is named “PSR-S970_InstrumentInfo.n27” or “PSR-S770_InstrumentInfo.n27.”

Contents

Chord Fingering Types	25
• Chord Types Recognized in the Fingered Mode	26
Style Playback Related Settings	27
Memorizing Original Settings to One Touch Setting	29
Creating/Editing Styles (Style Creator)	30
• Basic Procedure for Creating a Style	30
• Realtime Recording	32
• Step Recording (EDIT)	36
• Style Assembly (ASSEMBLY)	36
• Editing the Rhythmic Feel (GROOVE)	38
• Editing Data for Each Channel (CHANNEL)	40
• Making Style File Format Settings (PARAMETER)	41
• Editing the Rhythm Part of a Style (Drum Setup)	46

Style Types (Characteristics)

The particular type of Style is indicated at the upper left of the Style name in the Style Selection display. The defining characteristics of these Styles and their performance advantages are described below.







- **Pro:** These Styles provide professional and exciting arrangements combined with perfect playability. The resulting accompaniment exactly follows the chords of the player. As a result, your chord changes and colorful harmonies are instantly transformed into lifelike musical accompaniment.
- **Session:** These Styles provide even greater realism and authentic backing by mixing in original chord types and changes, as well as special riffs with chord changes, with the Main sections. These have been programmed to add “spice” and a professional touch to your performances of certain songs and in certain genres. Keep in mind, however, that the Styles may not necessarily be appropriate—or even harmonically correct—for all songs and for all chord playing. In some cases for example, playing a simple major triad for a country song may result in a “jazzy” seventh chord, or playing an on-bass chord may result in inappropriate or unexpected accompaniment.
- **Free Play:** These Styles are characterized by rubato performance. You can perform freely with remarkably expressive accompaniment, without being constrained by a strict tempo.
- **DJ:** Indicates the DJ Style. For more information on DJ Styles, refer to the Owner’s Manual.
- **+Audio (PSR-S970):** Indicates the Audio Style. For more information on Audio Styles, refer to the Owner’s Manual.

For the Preset Style List, refer to the Data List on the website.

Chord Fingering Types

The Chord Fingering type determines how chords are specified for Style playback. The type can be changed from: [FUNCTION] → TAB [◀] MENU 1 → [A] SPLIT POINT/CHORD FINGERING → TAB [▶] CHORD FINGERING.

SINGLE FINGER	<p>Makes it simple to produce orchestrated accompaniment using major, seventh, minor and minor-seventh chords by pressing only one, two or three keys on the Chord section of the keyboard.</p> <div style="display: flex; justify-content: space-around;"> <div style="text-align: center;">  <p>C For a major chord, press the root key only.</p> </div> <div style="text-align: center;">  <p>C7 For a seventh chord, simultaneously press the root key and a white key to its left.</p> </div> </div> <div style="display: flex; justify-content: space-around; margin-top: 10px;"> <div style="text-align: center;">  <p>Cm For a minor chord, simultaneously press the root key and a black key to its left.</p> </div> <div style="text-align: center;">  <p>Cm7 For a minor-seventh chord, simultaneously press the root key and both a white and black key to its left.</p> </div> </div>
MULTI FINGER	Automatically detects Single Finger or Fingered chord fingerings, so you can use either type of fingering without having to switch fingering types.
FINGERED	Lets you specify the chord by pressing the notes making up a chord in the left hand section of the keyboard when [ACMP] is turned on or the Left part is turned on. For information on which notes to press for each chord, refer to page 26 , or use the Chord Tutor function on the right-half of this display.
FINGERED ON BASS	Accepts the same fingerings as Fingered, but the lowest note played in the Chord section of the keyboard is used as the bass note, allowing you to play “on bass” chords. (In the Fingered type, the root of the chord is always used as the bass note.)
FULL KEYBOARD	Detects chords in the entire key range. Chords are detected in a way similar to Fingered, even if you split the notes between your left and right hands—for example, playing a bass note with your left hand and a chord with your right, or by playing a chord with your left hand and a melody note with your right.
AI FINGERED	Basically the same as Fingered, with the exception that less than three notes can be played to indicate the chords (based on the previously played chord, etc.).
AI FULL KEYBOARD	This type is similar to Full Keyboard, with the exception that less than three notes can be played to indicate the chords (based on the previously played chord, etc.). 9th, 11th and 13th chords cannot be played.

NOTE “AI” stands for “Artificial Intelligence.”

Chord Types Recognized in the Fingered Mode

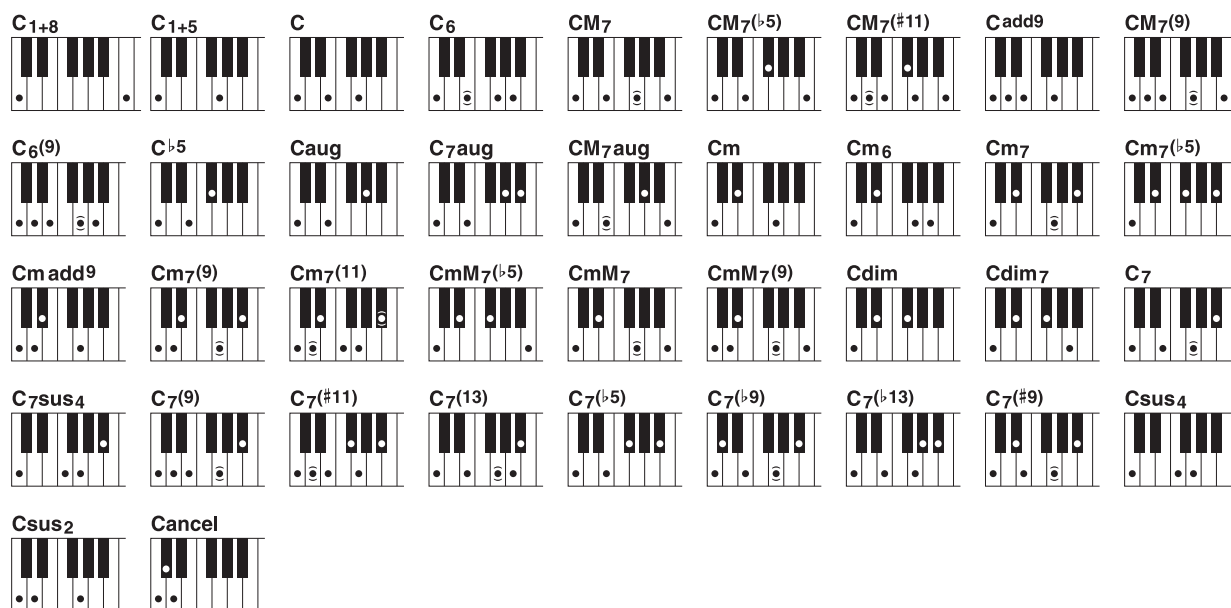

2

Styles

Chord Name [Abbreviation]	Normal Voicing*	Display for root "C"
1+8	1+8	C1+8
1+5	1+5	C1+5
Major [M]	1+3+5	C
Sixth [6]	1+(3)+5+6	C6
Major seventh [M7]	1+3+(5)+7	CM7
Major seventh flatted fifth [M7b5]	1+3+ \flat 5+7	CM7(\flat 5)
Major seventh add sharp eleventh [M7(#11)]	1+(2)+3+ \sharp 4+5+7	CM7(#11)
Add ninth [(add9)]	1+2+3+5	Cadd9
Major seventh ninth [M7_9]	1+2+3+(5)+7	CM7(9)
Sixth ninth [6_9]	1+2+3+(5)+6	C6(9)
Flatted fifth [(b5)]	1+3+ \flat 5	C \flat 5
Augmented [aug]	1+3+ \sharp 5	Caug
Seventh augmented [7aug]	1+3+ \sharp 5+ \flat 7	C7aug
Major seventh augmented [M7aug]	1+(3)+ \sharp 5+7	CM7aug
Minor [m]	1+ \flat 3+5	Cm
Minor sixth [m6]	1+ \flat 3+5+6	Cm6
Minor seventh [m7]	1+ \flat 3+(5)+ \flat 7	Cm7
Minor seventh flatted fifth [m7b5]	1+ \flat 3+ \flat 5+ \flat 7	Cm7(\flat 5)
Minor add ninth [m(9)]	1+2+ \flat 3+5	Cm add9
Minor seventh ninth [m7(9)]	1+2+ \flat 3+(5)+ \flat 7	Cm7(9)
Minor seventh eleventh [m7(11)]	1+(2)+ \flat 3+4+5+(\flat 7)	Cm7(11)
Minor major seventh flatted fifth [mM7b5]	1+ \flat 3+ \flat 5+7	CmM7(\flat 5)
Minor major seventh [mM7]	1+ \flat 3+(5)+7	CmM7
Minor major seventh ninth [mM7(9)]	1+2+ \flat 3+(5)+7	CmM7(9)
Diminished [dim]	1+ \flat 3+ \flat 5	Cdim
Diminished seventh [dim7]	1+ \flat 3+ \flat 5+6	Cdim7
Seventh [7]	1+3+(5)+ \flat 7	C7
Seventh suspended fourth [7sus4]	1+4+5+ \flat 7	C7sus4
Seventh ninth [7(9)]	1+2+3+(5)+ \flat 7	C7(9)
Seventh add sharp eleventh [7(#11)]	1+(2)+3+ \sharp 4+5+ \flat 7	C7(#11)
Seventh add thirteenth [7(13)]	1+3+(5)+6+ \flat 7	C7(13)
Seventh flatted fifth [7b5]	1+3+ \flat 5+ \flat 7	C7(\flat 5)
Seventh flatted ninth [7b9]	1+ \flat 2+3+(5)+ \flat 7	C7(\flat 9)
Seventh add flatted thirteenth [7(b13)]	1+3+5+ \flat 6+ \flat 7	C7(\flat 13)
Seventh sharp ninth [7(#9)]	1+ \sharp 2+3+(5)+ \flat 7	C7(#9)
Suspended fourth [sus4]	1+4+5	Csus4
One plus two plus five [sus2]	1+2+5	Csus2
cancel	1+ \flat 2+2	Cancel

* Notes in parentheses can be omitted.

Style Playback Related Settings

The instrument has a variety of settings for Style playback which can be accessed in the display below.

1 Call up the operation display.

[FUNCTION] → TAB [◀] MENU 1 → [G] STYLE SETTING

2 Use the [B]/[C] and [1 ▲▼]–[8 ▲▼] buttons for each setting.

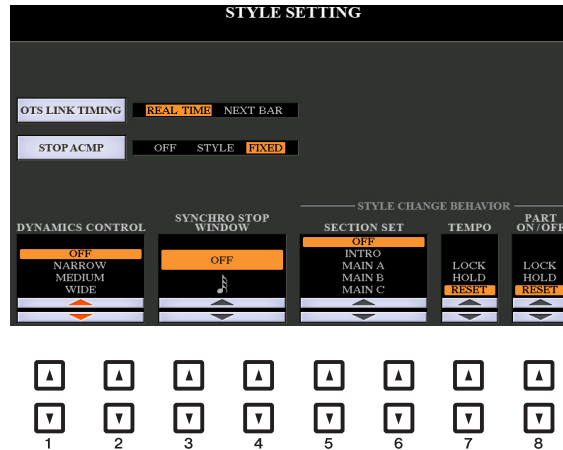

[B]	OTS LINK TIMING	<p>This applies to the OTS Link function. This parameter determines the timing in which the One Touch Settings change with the MAIN VARIATION [A]–[D] change. (The [OTS LINK] button must be on.)</p> <p>REAL TIME: One Touch Setting is immediately called up when you press a MAIN VARIATION button.</p> <p>NEXT BAR: One Touch Setting is called up at the next measure, after you press a MAIN VARIATION button.</p>
[C]	STOP ACMP	<p>When [ACMP] is turned on and [SYNC START] is off, you can play chords in the chord section of the keyboard with the Style stopped, and still hear the accompaniment chord. In this condition—called “Stop Accompaniment”—any valid chord fingerings are recognized and the chord root/type are shown in the display. Here, you can determine whether the chord played in the chord section will sound or not in the Stop Accompaniment status.</p> <p>OFF: The chord played in the chord section will not sound.</p> <p>STYLE: The chord played in the chord section will sound via the Voices for the Pad channel and the Bass channel of the selected Style.</p> <p>FIXED: The chord played in the chord section will sound via the specified Voice, regardless of the selected Style.</p> <p>NOTE When the selected Style contains MegaVoices, unexpected sounds may result when this is set to “STYLE.”</p> <p>NOTE When you record a Song, the chord detected by playing the Stop Accompaniment can be recorded regardless of the setting here. Please note that both the sounding Voice and chord data is recorded when set to “STYLE,” and only the chord data is recorded when set to “OFF” or “FIXED.”</p>

[1 ▲▼]/ [2 ▲▼]	DYNAMICS CONTROL	<p>This determines how the Style playback volume changes depending on the playing strength.</p> <p>OFF: The volume is kept the same regardless of playing strength.</p> <p>NARROW: The volume changes over a narrow range.</p> <p>MEDIUM: The volume changes over a medium range.</p> <p>WIDE: The volume changes over a wide range.</p>
[3 ▲▼]/ [4 ▲▼]	SYNCHRO STOP WINDOW	<p>This determines how long you can hold a chord before the Synchro Stop function is automatically cancelled. When the [SYNC STOP] button is turned on and this is set to a value other than “OFF,” this automatically cancels the Synchro Stop function if you hold a chord for longer than the time set here. This conveniently resets Style playback control to normal, letting you release the keys and still have the Style play. In other words, if you release the keys sooner than the time set here, the Synchro Stop function works.</p>
[5 ▲▼]/ [6 ▲▼]	SECTION SET	<p>Determines the default section that is automatically called up when selecting different Styles (when Style playback is stopped). When set to “OFF” and Style playback is stopped, the active section is maintained even if the different Style is selected. When any of the MAIN A–D sections is not included in the Style data, the nearest section is automatically selected. For example, when MAIN D is not contained in the selected Style, MAIN C will be called up.</p>
[7 ▲▼]	TEMPO	<p>This determines whether the tempo setting of the Style changes or not when you change Styles.</p> <p>LOCK: The previous tempo setting is always maintained.</p> <p>HOLD: During Style playback, the previous tempo setting is maintained. When Style playback is stopped, the tempo changes to that of the default tempo for the selected Style.</p> <p>RESET: The tempo always changes to that of the default tempo for the selected Style.</p>
[8 ▲▼]	PART ON/OFF	<p>This determines whether the Style Channel On/Off status changes or not when you change Styles.</p> <p>LOCK: The Channel On/Off status of the previous Style is always maintained.</p> <p>HOLD: During Style playback, the Channel On/Off status of the previous Style is maintained. When Style playback is stopped, all Style Channels are set to On.</p> <p>RESET: All Style Channels are set to On.</p>

Memorizing Original Settings to One Touch Setting

You can memorize your original panel settings to a One Touch Setting. The newly created One Touch Setting will be saved in the USER drive or a USB flash drive as a Style, and you can call up the One Touch Setting as a part of the Style.

- 1** Select the desired Style to memorize your One Touch Setting.
- 2** Make the desired panel settings, such as those for Voices and effects.
- 3** Press the [MEMORY] button in the REGISTRATION MEMORY section.

The REGISTRATION MEMORY CONTENTS display appears. However you do not need to make any settings here, since the On/Off settings in this display do not affect the One Touch Setting function.

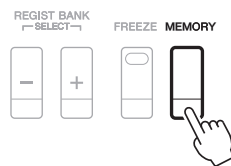

- 4** Press one of the ONE TOUCH SETTING [1]–[4] buttons to which you wish to memorize your panel settings.

A message appears. If you are sure you want to memorize the current settings to the selected button, press the [F] (YES) button. If you want to change the settings, press the [G] (NO) button, then repeat steps 2–4 as necessary.

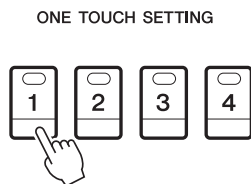

NOTE For ONE TOUCH SETTING buttons to which your original panel settings have not been memorized, the OTS settings of the original Style will be maintained.

- 5** Press the [F] (YES) button to call up the Style Selection display and save the One Touch Setting as a Style.

For instructions on the Save operation, refer to “Basic Operations” in the Owner’s Manual.

NOTICE

The memorized panel settings (One Touch Settings) will be lost if you change the Style or turn the power off without carrying out the Save operation.

Creating/Editing Styles (Style Creator)

A Style is made up of the different Sections (Intro, Main, Ending, etc.) and each Section has separate channels (rhythm pattern, bass line, chord backing, pad, or phrase, each of which is referred to as a “Source Pattern”). With the Style Creator function, you can create an original Style by separately recording the channels, or by copying pattern data from other existing Styles.

(PSR-S970) Limitations on the Audio part:

- If you select a preset Audio Style as starting data, the Audio part is to be used as is. The Audio part cannot be deleted, edited and created from scratch.
- The created Style containing the Audio part can be used only via an instrument that supports Audio Styles as well as the SFF GE format.
- The Audio part cannot be copied from another Style or Section in the ASSEMBLY page. If you want to use a specific Audio part, make sure to select the corresponding Audio Style before calling up the Style Creator display.

2

Styles

Basic Procedure for Creating a Style

1 Select the desired Style to be used as the basis for the new Style.

2 Call up the Style Creator display.

[FUNCTION] → TAB [▶] MENU 2 → [A] STYLE CREATOR

3 From the BASIC page, select a Section.

(If the RECORD display is shown in the lower half section of the display, press the [EXIT] button.) Press the [A] button to select “1 SECTION;” then use the [3 ▲▼]/[4 ▲▼] buttons to select a Section. Carry out the following operations as necessary.

- If you create a Style entirely from scratch, press the [C] (NEW STYLE) button to call up an empty new Style.
- For the current Section, select the pattern length via the [5 ▲▼]/[6 ▲▼] buttons. After selecting, press the [D] (EXECUTE) button to actually enter the specified length.
Note that if an Audio Style is selected as the basic data (PSR-S970), changing the pattern length deletes the corresponding Audio part.
- For the entire current Style, use the [A]/[B] buttons to select “2 TEMPO/BEAT;” then set the Tempo via the [3 ▲▼]/[4 ▲▼] buttons, and the Time Signature via the [5 ▲▼]/[6 ▲▼] buttons.

NOTE Even when you are editing an existing Style, changing the Time Signature (BEAT) clears the data from all sections, and you will need to create the Style from scratch.

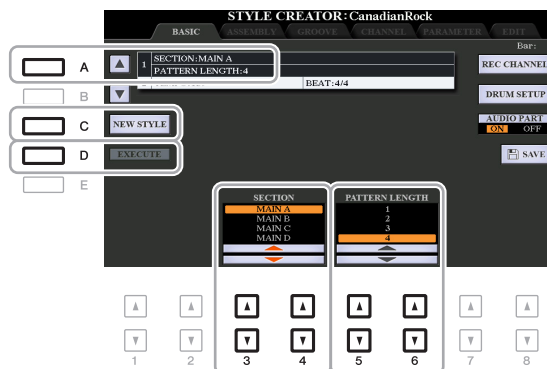

NEXT PAGE

4 Create the Source Pattern for each channel.

- **Realtime Recording on the BASIC page (page 32)**
Lets you record the Style by simply playing the keyboard.
- **Step Recording on the EDIT page (page 36)**
Lets you enter each note individually.
- **Style Assembly on the ASSEMBLY page (page 36)**
Lets you copy various patterns from other preset Styles or Styles you have already created.

5 Edit the already recorded channel data.

- **Editing the channel data on the GROOVE (page 38), CHANNEL (page 40), and EDIT (page 36) pages**
Lets you change the rhythmic feel, quantizing and velocity, etc.
- **Editing the SFF parameters on the PARAMETER page (page 41)**
Lets you edit the SFF (Style File Format) related parameters of the already recorded channels.
- **Editing the rhythm part on the BASIC page by using the Drum Setup function (page 46)**
Lets you edit the rhythm part of the Style, such as changing the sounds of the individual instruments.

6 Repeat steps 3–5 as desired.

7 Press the [I] or [J] (SAVE) button on any of the pages to save the created Style.

For instructions, refer to “Basic Operations” in the Owner’s Manual.

NOTICE

The created Style will be lost if you change to another Style or turn off the power to the instrument without carrying out the Save operation.

Realtime Recording

In the BASIC page, you can record your original rhythm pattern from the keyboard.

Realtime Recording Characteristics in the Style Creator

- **Loop Recording**

Style playback repeats the rhythm patterns of several measures in a “loop,” and Style recording is also done using loops. For example, if you start recording with a two-measure MAIN section, the two measures are repeatedly recorded. Notes that you record will play back from the next repetition (loop), letting you record while hearing previously recorded material.

- **Overdub Recording**

This method records new material to a channel already containing recorded data, without deleting the original data. In Style recording, the recorded data is not deleted, except when using functions such as Rhythm Clear (page 33) and Delete (pages 33, 35). For example, if you start recording with a two-measure MAIN section, the two measures are repeated many times. Notes that you record will play back from the next repetition, letting you overdub new material to the loop while hearing previously recorded material. When creating a Style based on an existing internal Style, overdub recording is applied only to the rhythm channels. For all other channels (except rhythm), you need to delete the original data before recording.

2

Styles

■ Recording Rhythm Channels 1–2

The procedure below applies to step 4 in the Basic Procedure on page 31.

- **(PSR-S970) If you select an Audio Style as the basic data:**

Playback of the Audio part can be turned on or off via the [H] (AUDIO PART) button, but it cannot be edited or deleted. Note that the rhythm pattern of this part will be used in the new Style you intend to create. If you want to create a rhythm phrase in addition to the Audio part, follow the steps below.

1 From the BASIC page, while holding down the [F] (REC CHANNEL) button, press the [1 ▼] or [2 ▼] button to select the desired channel as the recording target.

A Rhythm channel can be selected as the recording target no matter whether already recorded data is included or not. If already recorded data is included in the selected channel, you can record notes additionally to the existing data.

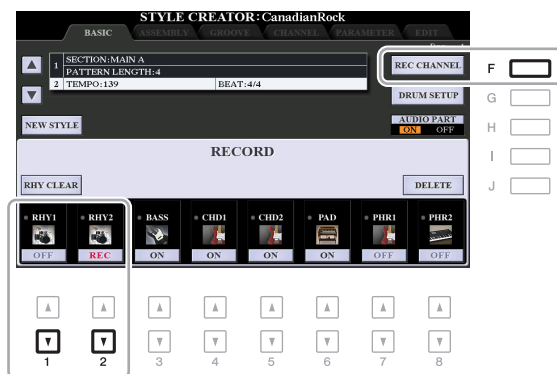

 NEXT PAGE

2 If necessary, select a Voice then practice the rhythm pattern to be recorded.

Press the [1 ▲] or [2 ▲] button (selected channel) to call up the Voice Selection display then select the desired Voice such as a Drum Kit. After selecting, press the [EXIT] button to return to the original Style Creator display. With the selected Voice, practice the rhythm pattern to be recorded.

• Available Voices for recording

For the RHY1 channel, any except the Organ Flutes Voices can be used for recording.

For the RHY2 channel, only Drum/SFX Kits can be used for recording.

NOTE For information on which key to play for each Drum/SFX sound, refer to the "Drum/SFX Kit List" in the Data List on the website.

3 Press the STYLE CONTROL [START/STOP] button to start recording.

As the already recorded data plays back, use the [1 ▼]–[8 ▼] buttons to turn each channel on or off as desired. If you selected an Audio Style as starting data (PSR-S970), turn the Audio part on or off via the [H] button.

If necessary, you can delete channel data. While holding down the [J] (DELETE) button, press one of the [1 ▲]–[8 ▲] (desired channel) buttons.

4 As soon as loop playback returns to the first beat in the first measure, start playing the rhythm pattern to be recorded.

If the rhythm is difficult to play in real time, break it up into individual parts and play each separately as the playback loops, as shown in the example below.

The diagram illustrates three sequential drum loops, each shown in a separate box with a downward arrow indicating the progression:

- Loop 1st round:** Shows a single staff for Bass Drum with a rhythmic pattern of quarter notes and eighth notes.
- Loop 2nd round:** Shows two staves: Snare Drum and Bass Drum. The Snare Drum part has a rhythmic pattern of eighth notes, while the Bass Drum part has the same pattern as in the first loop.
- Loop 3rd round:** Shows three staves: Hi-Hat, Snare Drum, and Bass Drum. The Hi-Hat part has a rhythmic pattern of eighth notes, the Snare Drum part has the same pattern as in the second loop, and the Bass Drum part has the same pattern as in the first loop.

Deleting mistakenly recorded notes (Rhythm Clear)

If you make a mistake or play any wrong notes, you can delete those specific notes. While holding down the [E] (RHY CLEAR) button, press the corresponding key on the keyboard.

5 Press the [START/STOP] button to stop playback.

If you want to add more notes, press the [START/STOP] button again to continue recording.

6 Press the appropriate [1 ▼] or [2 ▼] button to disable recording.

NOTICE

The created Style will be lost if you change to another Style or turn off the power to the instrument without carrying out the Save operation (step 7 on page 31).

■ Recording to the Bass, Chord 1–2, Pad and Phrase 1–2 Channels

The procedure below applies to step 4 in the Basic Procedure on [page 31](#).

1 From the BASIC page, while holding down the [F] (REC CHANNEL) button, press one of the [3 ▼]–[8 ▼] buttons to select the desired channel as the recording target.

If a preset Style is selected, a confirmation message appears, prompting you whether or not to delete the already recorded data of the selected channel. Press the [G] (YES) button to delete data and the selected channel is specified as the recording target. Note that channel data other than the Rhythm channels of the preset Style cannot be overdubbed.



2 If necessary, select a Voice then practice the bass line, chord backing, or phrase to be recorded.

Press one of the [3 ▲]–[8 ▲] buttons (selected channel) to call up the Voice Selection display then select the desired Voice. After selecting, press the [EXIT] button to return to the original display. With the selected Voice, practice the phrase or chord backing to be recorded.

- **Available Voices for recording**

Any except for the Organ Flutes Voice/Drum Kit/SFX kit Voices can be used for recording.

- **Record a phrase in CM7 (for playing appropriate notes while chords change during performance)**
Rules when recording a Main or Fill

With the default initial settings, the Source Root/Chord ([page 42](#)) is set to CM7. This means that you should record a Source Pattern using a CM7 scale, which will change according to the chords you specify during normal performance. Record a bass line, phrase or chord backing which you want to hear when CM7 is specified. See below for details.

- Use only the CM7 scale tones when recording the BASS and PHRASE channels (i.e., C, D, E, G, A, and B).
- Use only the chord tones when recording the CHORD and PAD channels (i.e., C, E, G, and B).



C = Chord note
C, R = Recommended note

If you observe this rule, Style playback notes are appropriately converted depending on the chord changes you make during your performance.

Rules when recording an Intro or Ending

These Sections are designed assuming that the chord is not changed during playback. This is why you need not observe the rule for Main and Fill-in Sections described above, and you can create special chord progressions when recording. However, follow the rules below since the Source Root/Chord is set to CM7.

- When recording the Intro, make sure that the recorded phrase leads properly into a C scale.
- When recording the Ending, make sure that the recorded phrase begins with or properly follows a C scale.



- **Set the Source Root/Chord if necessary**

Although the Source Root/Chord is set to CM7 as described above, you can change this to any desired key or chord. Use the TAB [◀][▶] buttons to call up the PARAMETER page, and set the PLAY ROOT and CHORD to the favorite or desired Root and Chord type. Keep in mind that when you change the Source Chord from the default CM7 to another chord, the chord notes and recommended notes will also change. For details, refer to [page 42](#).

3 Press the STYLE CONTROL [START/STOP] button to start recording.

Since already recorded data plays back, use the [1 ▼]–[8 ▼] buttons to turn on or off each channel as desired. If you selected an Audio Style as starting data (PSR-S970), turn on or off the Audio part via the [H] button.

If necessary, you can delete channel data. While holding down the [J] (DELETE) button, press one of the [1 ▲]–[8 ▲] (desired channel) buttons.

4 As soon as loop playback returns to the first beat in the first measure, start playing the bass line, chord backing or phrase to be recorded.

5 Press the [START/STOP] button to stop playback.

If you want to add more notes, press the [START/STOP] button again to continue recording.

- **To hear the playback sound of the already recorded channels with another Source Root/Chord:**

- 1) Use the TAB [◀][▶] buttons to call up the PARAMETER page.
- 2) Press the [F] (REC CHANNEL) button to call up the RECORD display, then use the [1 ▼]–[8 ▼] buttons to turn the desired channel ON/OFF.
- 3) Press the STYLE CONTROL [START/STOP] button to start playback.
- 4) On the PARAMETER page, set the PLAY ROOT and CHORD to the desired Chord root and Chord type.

The above operation lets you hear how the Source Pattern is played back via chord changes during normal performance.

6 Press the appropriate [3 ▼]–[8 ▼] button to disable recording.

NOTICE

The created Style will be lost if you change to another Style or turn off the power to the instrument without carrying out the Save operation (step 7 on [page 31](#)).

Step Recording (EDIT)

This section applies to step 4 of the Basic Procedure on [page 31](#). After selecting a Section and make other settings on the BASIC page, call up the STEP RECORD display via the instructions below, then carry out Step Recording.

- 1) From the BASIC page, while holding down the [F] (REC CHANNEL) button, press one of the [1 ▼]–[8 ▼] buttons to select the desired channel as the recording target.
- 2) Use the TAB [▶] button to call up the EDIT page.
- 3) If “SYS/EX.” is shown at the position corresponding to the [F] button, press the [F] button to call up the Channel Edit display.
- 4) Press the [G] (STEP REC) button to call up the STEP RECORD display.

The Step Recording procedure in the Style Creator is essentially same as that in Song Creator ([pages 59–62](#)), with the exception of the following points:

- Unlike in Song Creator, the “End” mark position cannot be changed in the Style Creator. This is because setting the Pattern Length on the BASIC page determines the “End” mark position. For example, if you select a Section of four measures or you set the Pattern Length to “4” on the BASIC page, the “End” mark position is automatically set to the end of the fourth measure, and cannot be changed.
- Unlike in Song Creator, a Recording channel can be set on the BASIC page. It cannot be set on the EDIT page.
- Unlike in Song Creator, Chord and Lyrics data cannot be entered. This is because such data is not necessary for Style playback.

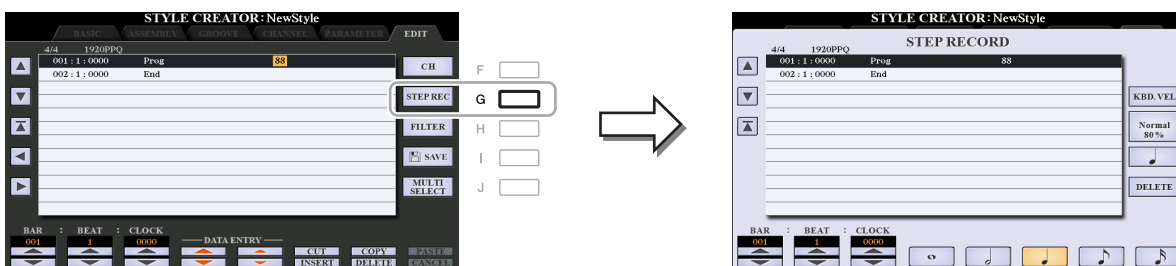

For instructions on Step Recording, refer to [pages 59–62](#). For information on the EDIT page (called as Event List display in Song Creator), refer to [page 72](#).

Style Assembly (ASSEMBLY)

This allows you to copy channel data as a Source Pattern from another preset Style to the currently created Style. Use this function if you find a favorite rhythm pattern, bass line, chord backing or phrase from another Style.

The instructions below apply to step 4 of the Basic Procedure on [page 31](#). After selecting a Section and make other settings on the BASIC page, carry out the instructions below.

NOTE (PSR-S970) An Audio part cannot be copied from another Style.

NOTE (PSR-S970) If you select an Audio Style as starting data, the Audio part cannot be replaced with different data.

1 Call up the operation display.

[FUNCTION] → TAB [▶] MENU 2 → [A] STYLE CREATOR → TAB [◀][▶] ASSEMBLY

2 If necessary, select the Section to be edited.

Even if the Section to be edited has already been selected on the BASIC page, you can change the Section also on this page. Press the desired Section button on the panel to call up the SECTION window, then press the [8 ▲] (OK) button to actually enter the selection. If you want to select a fill-in section (which has no panel button), press any one of the Section buttons and use the [6 ▲▼]/[7 ▲▼] buttons to select a fill-in, then press the [8 ▲] (OK) button.



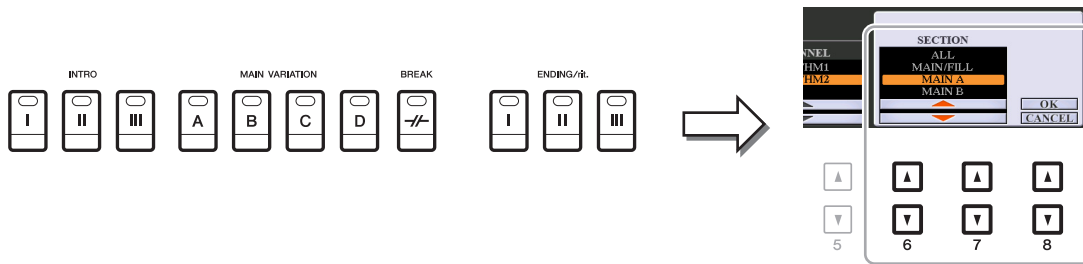

NOTE Intro 4 and Ending 4 can be selected on the display then created as your original Style although they are not available on the panel.

3 Replace the Source Pattern of the specific channel with that of another Style.

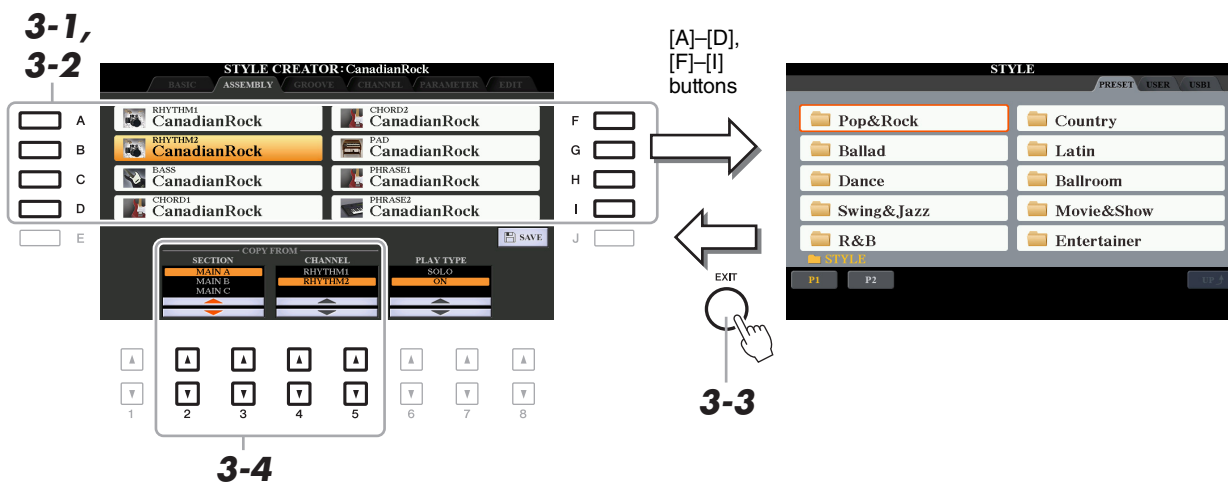

- 3-1** Select the desired channel to be replaced via the [A]–[D] and [F]–[I] buttons.
- 3-2** Press the same button of the selected channel to call up the Style Selection display.
- 3-3** Select the desired Style, then press the [EXIT] button to return to the original display.
- 3-4** Select the Section and Channel of the selected Style via the [2 ▲▼]–[5 ▲▼] buttons.
- 3-5** Confirm the sound with the newly assigned Source Pattern by pressing the STYLE CONTROL [START/STOP] button to play back the Style.

Playing the Style During Style Assembly

You can play back the Style while you are assembling a Style, and the playback method can be selected. In the ASSEMBLY page, use the [6 ▲▼]/[7 ▲▼] (PLAY TYPE) buttons to select the type.

- **SOLO:** Plays back the selected channel in the ASSEMBLY page. Any channels set to REC in the RECORD display on the BASIC page are played back simultaneously.
- **ON:** Plays back the selected channel in the ASSEMBLY page. Any channels set to other than OFF in the RECORD display on the BASIC page are played back simultaneously.
- **OFF:** Mutes the selected channel in the ASSEMBLY page.

4 As desired, repeat step 3 for another channel.

NOTICE

The created Style will be lost if you change to another Style or turn off the power to the instrument without carrying out the Save operation (step 7 on page 31).

Editing the Rhythmic Feel (GROOVE)

By changing the timing of all the notes and velocities, you can edit the rhythmic feel for each channel of the current Section selected on the BASIC page or the panel button. The instructions below apply to step 5 of the Basic Procedure on [page 31](#).



- In the GROOVE page, use the [A]/[B] buttons to select the edit menu, then edit the data by using the [1 ▲▼]–[8 ▲▼] buttons.

1 GROOVE

This lets you add swing to the music or change the “feel” of the beat by making subtle shifts in the timing (clock) of the Style. The Groove settings are applied to all channels of the Section selected on the BASIC page.

[1 ▲▼]/ [2 ▲▼]	ORIGINAL BEAT	Specifies the beats to which Groove timing is to be applied. In other words, if “8 BEAT” is selected, Groove timing is applied to 8th notes; if “12 BEAT” is selected, Groove timing is applied to 8th-note triplets.
[3 ▲▼]/ [4 ▲▼]	BEAT CONVERTER	Actually changes the timing of the beats (specified in the ORIGINAL BEAT parameter above) to the selected value. For example, when ORIGINAL BEAT is set to “8 BEAT” and BEAT CONVERTER is set to “12,” all 8th notes in the section are shifted to 8th-note triplet timing. The “16A” and “16B” Beat Converter which appear when ORIGINAL BEAT is set to “12 BEAT” are variations on a basic 16th-note setting.
[5 ▲▼]/ [6 ▲▼]	SWING	Produces a “swing” feel by shifting the timing of the back beats, depending on the ORIGINAL BEAT parameter above. For example, if the specified ORIGINAL BEAT value is “8 BEAT”, the Swing parameter will selectively delay the 2nd, 4th, 6th, and 8th beats of each measure to create a swing feel. The settings “A” through “E” produce different degrees of swing, with “A” being the most subtle and “E” being the most pronounced.
[7 ▲▼]/ [8 ▲▼]	FINE	Selects a variety of Groove “templates” to be applied to the selected section. The “PUSH” settings cause certain beats to be played early, while “HEAVY” settings delay the timing of certain beats. The numbered settings (2, 3, 4, 5) determine which beats are to be affected. All beats up to the specified beat—but not including the first beat—will be played early or delayed (for example, the 2nd and 3rd beats, if “3” is selected). In all cases, “A” types produce minimum effect, “B” types produce medium effect, and “C” types produce maximum effect.

2 DYNAMICS

This changes the velocity/volume (or accent) of certain notes in the Style playback. The Dynamics settings are applied to each channel or all channels of the Section selected on the BASIC page.

[1 ▲▼]/ [2 ▲▼]	CHANNEL	Selects the desired channel (part) to which Dynamics is to be applied. The selected channel is shown at the upper left of the display.
[3 ▲▼]/ [4 ▲▼]	ACCENT TYPE	Determines the type of accent applied—in other words, which notes in the part(s) are emphasized with the Dynamics settings.
[6 ▲▼]	STRENGTH	Determines how strongly the selected Accent Type (above) will be applied. The higher the value, the stronger the effect.
[7 ▲▼]	EXPAND/CMP.	Expands or compresses the range of velocity values. Values higher than 100% expand the dynamic range, while values lower than 100% compress it.
[8 ▲▼]	BOOST/CUT	Boosts or cuts all velocity values in the selected section/channel. Values above 100% boost the overall velocity, while values below 100% reduce it.

2 Press the [D] (EXECUTE) button to actually enter the edits for each display.

The values which are shown in the STRENGTH, EXPAND/CMP. and BOOST/CUT parameters are expressed as a percentage of the last set value.

After the operation is completed, this button changes to “UNDO,” letting you restore the original data if you are not satisfied with the Groove or Dynamics results. The Undo function only has one level; only the previous operation can be undone.

NOTICE

The edited Style will be lost if you change to another Style or turn off the power to the instrument without carrying out the Save operation (step 7 on page 31).

Editing Data for Each Channel (CHANNEL)

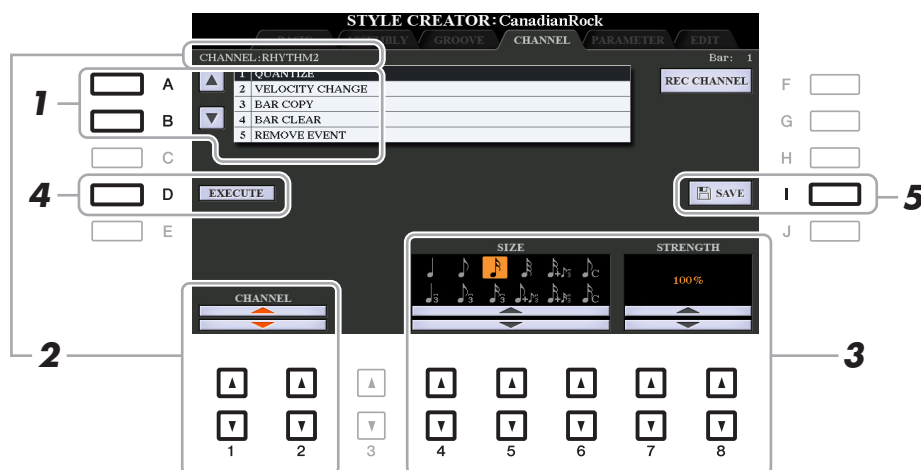

You can edit recorded data for each channel of the current Section selected on the BASIC page or via the panel buttons. The instructions below apply to step 5 of the Basic Procedure on [page 31](#).



1 In the CHANNEL page, use the [A]/[B] buttons to select the edit menu.

1 QUANTIZE

Same as in the Song Creator ([page 70](#)), with the exception of the two additional available parameters below.

-  Eighth notes with swing
-  Sixteenth notes with swing

2 VELOCITY CHANGE

Boosts or cuts the velocity of all notes in the specified channel, according to the percentage specified here.

3 BAR COPY

This function allows data to be copied from one measure or group of measures to another location within the specified channel.

[4 ▲▼]	TOP	Specifies the first (TOP) and last (LAST) measures in the region to be copied.
[5 ▲▼]	LAST	
[6 ▲▼]	DEST	Specifies the first measure of the destination location, to which the data is to be copied.

4 BAR CLEAR

This function clears all data from the specified range of measures within the selected channel.

5 REMOVE EVENT

This function lets you remove specific events from the selected channel.

2 Use the [1 ▲▼]/[2 ▲▼] (CHANNEL) buttons to select the channel to be edited.

The selected channel is shown at the upper left of the display.

3 Use the [4 ▲▼]–[8 ▲▼] buttons to edit the data.

4 Press the [D] (EXECUTE) button to actually enter the edits for each display.

After the operation is completed, this button changes to “UNDO,” letting you restore the original data if you are not satisfied with the results of the edit. The Undo function only has one level; only the previous operation can be undone.

NOTICE

The edited Style will be lost if you change to another Style or turn off the power to the instrument without carrying out the Save operation (step 7 on [page 31](#)).

Making Style File Format Settings (PARAMETER)

The Style File Format (SFF) combines all of Yamaha's auto accompaniment (Style playback) know-how into a single unified format. Setting the SFF related parameters determines how the original notes are converted to the actual sounded notes based on the chord you specify in the Chord area of the keyboard. The conversion flow is shown below.

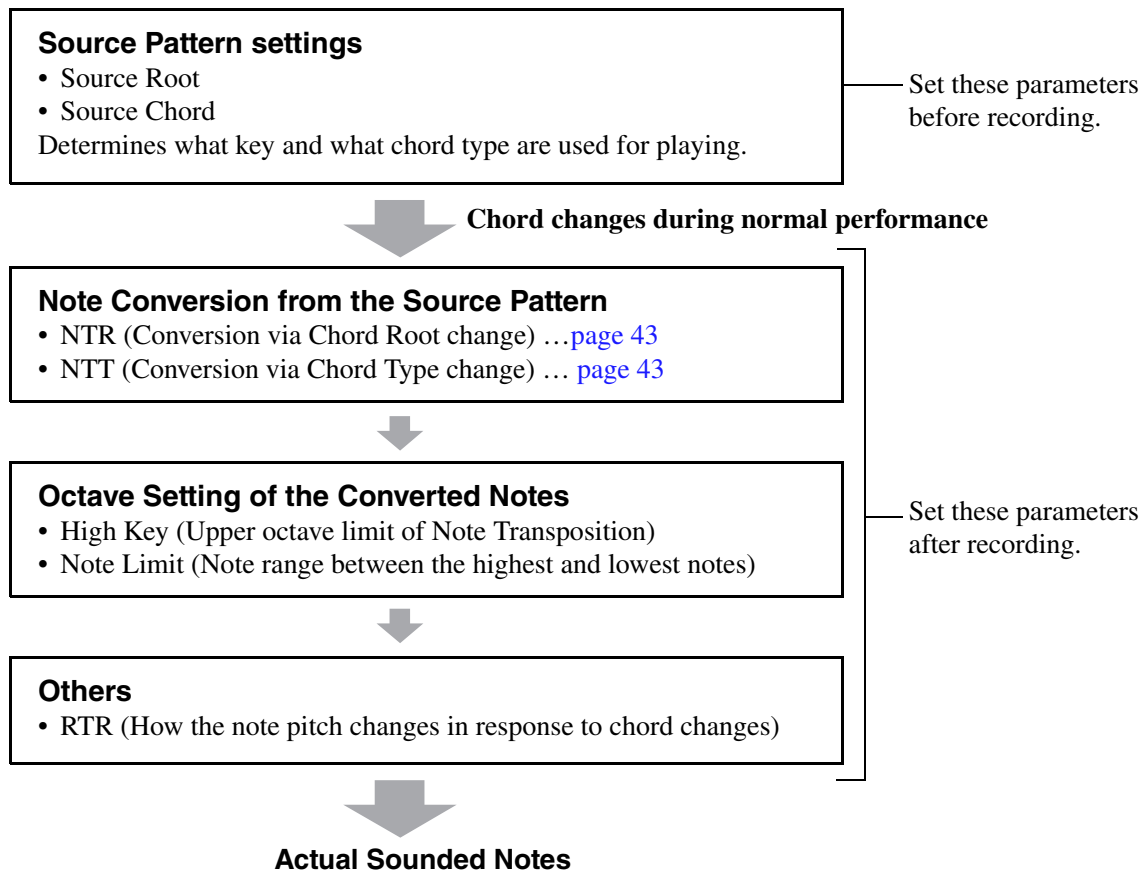

The instructions below apply to step 5 of the Basic Procedure on [page 31](#).

NOTE The parameters you can set here are compatible with the SFF GE format. This is why the Style files created on this instrument can be played back only on instruments which are compatible with SFF GE.

1 In the PARAMETER page, use the [A]/[B] buttons to select the edit menu.

For details of the edit menu, see [page 42](#).

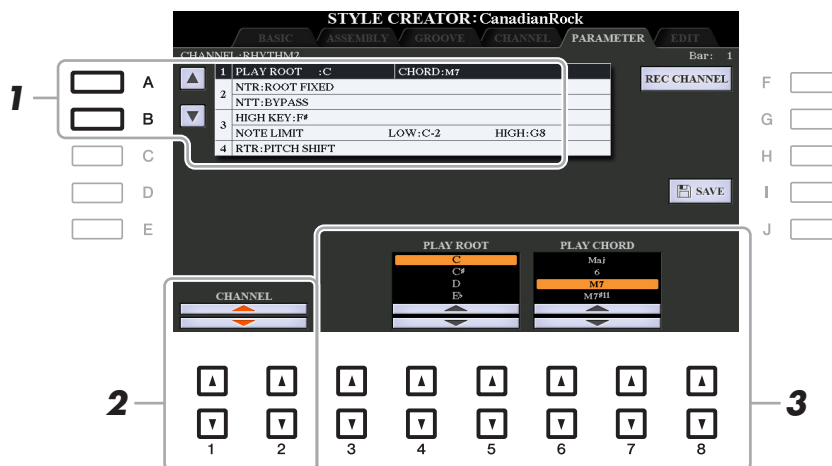

2 Use the [1 ▲▼]/[2 ▲▼] (CHANNEL) buttons to select the channel to be edited.

The selected channel is shown at the upper left of the display.

3 Use the [3 ▲▼]–[8 ▲▼] buttons to edit the data.

For details on editable parameters, see [pages 42–45](#).

NOTICE

The edited Style will be lost if you change to another Style or turn off the power to the instrument without carrying out the Save operation (step 7 on [page 31](#)).

1 SOURCE (PLAY) ROOT/CHORD

IMPORTANT

The parameters here should be set before recording. If you change the settings after recording, the appropriate note conversion cannot be done even when you specify various chord types.

Before recording, you should set these parameters which determine what key is used for playing when you record the Source Pattern to the Bass, Chord, Pad or Phrase channel. If you set this to “Fm7,” your recorded original phrase (Source Pattern) will be triggered by specifying Fm7 during normal performance. CM7 (Source Chord Root = C and Source Chord Type = M7) is set by default. Depending on the settings here, the playable notes (chord notes and recommended scale notes) will differ. For details, see below.

When the Source Root is C:

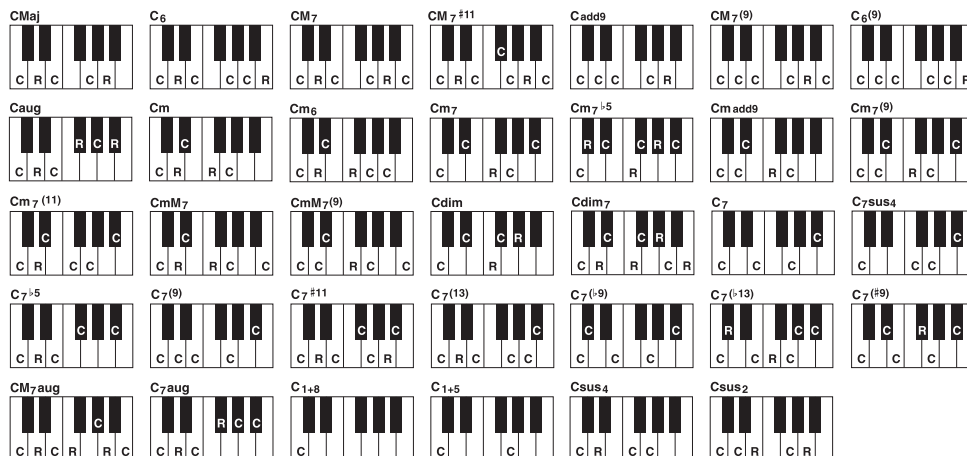

C = Chord notes
C, R = Recommended notes

NOTE When the parameters for the selected channel are set to NTR: ROOT FIXED, NTT: BYPASS, and NTT BASS: OFF, the parameters here are changed to “PLAY ROOT” instead of “SOURCE ROOT.” In this case, you can hear the resulting sound while you change the Chord Root/Type during playback.

NOTE The settings here are not applied when NTR is set to GUITAR.



NEXT PAGE

2 NTR/NTT

The settings here determine how the original notes of the Source Pattern are converted in response to the Chord change during normal performance.

[3 ▲▼]/ [4 ▲▼]	NTR (Note Transposition Rule)	Determines the relative position of the root note in the chord, when converted from the Source Pattern in response to chord changes. Refer to the list below.
[5 ▲▼]– [7 ▲▼]	NTT (Note Transposition Table)	Sets the note transposition table for the source pattern. Refer to the list below.
[8 ▲▼]	NTT BASS ON/OFF	The channel for which this is set to ON will be played back by the bass root note, when the on-bass chord is recognized by the instrument. When NTR is set to GUITAR and this parameter is set to ON, only the note which is assigned to bass will be played back by the bass root note.

NOTE Since the Rhythm channels should not be affected by chord changes, make sure that the parameters are set to NTR: ROOT FIXED, NTT: BYPASS, and NTT BASS: OFF. In this case, "SOURCE ROOT" is changed to "PLAY ROOT."

NTR (Note Transposition Rule)

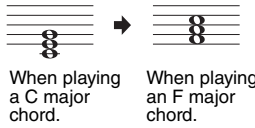
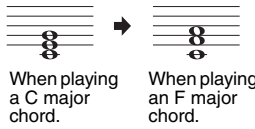
ROOT TRANS (Root Transpose)	When the root note is transposed, the interval between notes is maintained. For example, the notes C3, E3 and G3 in the key of C become F3, A3 and C4 when they are transposed to F. Use this setting for channels that contain melody lines.	 <p>When playing a C major chord. → When playing an F major chord.</p>
ROOT FIXED	The note is kept as close as possible to the previous note range. For example, the notes C3, E3 and G3 in the key of C become C3, F3 and A3 when they are transposed to F. Use this setting for channels that contain chord parts.	 <p>When playing a C major chord. → When playing an F major chord.</p>
GUITAR	This is exclusively for transposing guitar accompaniment. Notes are transposed to approximate the chords played with natural guitar fingering.	

NTT (Note Transposition Table)

When NTR is set to ROOT TRANS or ROOT FIXED

BYPASS	When NTR is set to ROOT FIXED, the transposition table used does not do any note conversion. When NTR is set to ROOT TRANS, the table used only converts the notes by maintaining the pitch relationship between notes.
MELODY	Suitable for melody line transposition. Use this for melody channels such as Phrase 1 and Phrase 2.
CHORD	Suitable for chordal parts transposition. Use this for the Chord 1 and Chord 2 channels, especially when they contain piano or guitar-like chordal parts.
MELODIC MINOR	When the played chord changes from a major to a minor chord, this table lowers the third interval in the scale by a semitone. When the chord changes from a minor to a major chord, the minor third interval is raised by a semitone. Other notes are not changed. Use this for melody channels of Sections which respond only to major/minor chords, such as Intros and Endings.
MELODIC MINOR 5th	In addition to the Melodic Minor transposition above, augmented and diminished chords affect the 5th note of the Source Pattern.

HARMONIC MINOR	When the played chord changes from a major to a minor chord, this table lowers the third and sixth intervals in the scale by a semitone. When the chord changes from a minor to a major chord, the minor third and flatted sixth intervals are raised by a semitone. Other notes are not changed. Use this for chord channels of Sections which respond only to major/minor chords, such as Intros and Endings.
HARMONIC MINOR 5th	In addition to the Harmonic Minor transposition above, augmented and diminished chords affect the 5th note of the Source pattern.
NATURAL MINOR	When the played chord changes from a major to a minor chord, this table lowers the third, sixth and seventh intervals in the scale by a semitone. When the chord changes from a minor to a major chord, the minor third, flatted sixth and flatted seventh intervals are raised by a semitone. Other notes are not changed. Use this for chord channels of Sections which respond only to major/minor chords such as in Intros and Endings.
NATURAL MINOR 5th	In addition to the Natural Minor transposition above, augmented and diminished chords affect the 5th note of the Source pattern.
DORIAN	When the played chord changes from a major to a minor chord, this table lowers the third and seventh intervals in the scale by a semitone. When the chord changes from a minor to a major chord, the minor third and flatted seventh intervals are raised by a semitone. Other notes are not changed. Use this for chord channels of Sections which respond only to major/minor chords such as in Intros and Endings.
DORIAN 5th	In addition to the Dorian transposition above, augmented and diminished chords affect the 5th note of the Source pattern.

When NTR is set to GUITAR

ALL-PURPOSE	This table covers both stroke- and arpeggio-played sounds.
STROKE	Suitable for strumming sounds of the guitar. Some notes may sound as if they are muted—this is the normal condition when chords are played on guitar by strumming.
ARPEGGIO	Suitable for arpeggio-played sound of the guitar, resulting in beautiful four-note arpeggio sounds.



NEXT PAGE

3 HIGH KEY / NOTE LIMIT

The settings here adjust the Octave of the notes converted from the original ones through NTT and NTR.

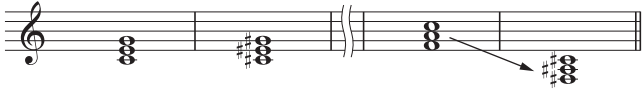
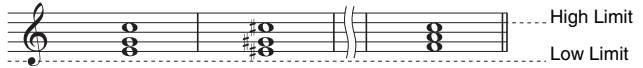
[4 ▲▼]/ [5 ▲▼]	HIGH KEY	<p>This sets the highest key (upper octave limit) of the note transposition for the chord root change. Any notes calculated to be higher than the highest key are transposed down to the next lowest octave. This setting is available only when the NTR parameter (page 43) is set to “Root Trans.”</p> <p>Example—When the highest key is F.</p> <p>Root changes → CM C#M . . . FM F#M . . .</p> <p>Notes played → C3-E3-G3 C#3-E#3-G#3 F3-A3-C4 F#2-A#2-C#3</p> 
[6 ▲▼]	NOTE LIMIT LOW	<p>These set the note range (highest and lowest notes) for Voices recorded to the Style channels. By judicious setting of this range, you can ensure that the Voices sound as realistic as possible—in other words, that no notes outside the natural range are sounded (e.g., high bass sounds or low piccolo sounds).</p> <p>Example—When the lowest note is C3 and the highest is D4.</p> <p>Root changes → CM C#M . . . FM . . .</p> <p>Notes played → E3-G3-C4 E#3-G#3-C#4 F3-A3-C4</p> 
[7 ▲▼]	NOTE LIMIT HIGH	

4 RTR (Retrigger Rule)

These settings determine whether notes stop sounding or not and how they change pitch in response to chord changes.

STOP	The notes stop sounding.
PITCH SHIFT	The pitch of the note will bend without a new attack to match the type of the new chord.
PITCH SHIFT TO ROOT	The pitch of the note will bend without a new attack to match the root of the new chord. However, the octave of the new note remains the same.
RETRIGGER	The note is retriggered with a new attack at a new pitch corresponding to the next chord.
RETRIGGER TO ROOT	The note is retriggered with a new attack at the root note of the next chord. However, the octave of the new note remains the same.

Editing the Rhythm Part of a Style (Drum Setup)

The Drum Setup function allows you to edit the rhythm part of the current Style, such as changing the drum instruments and make various settings. The procedure below applies to step 5 in the Basic Procedure on page 31.

- 1 From the **BASIC** page, while holding down the [F] (REC CHANNEL) button, press the [1 ▼] or [2 ▼] button to select the desired channel to be edited.

NOTE If the different drum sounds are assigned to each section of the selected channel, the sounds are set to that of the current section in order to use the Drum Setup function.

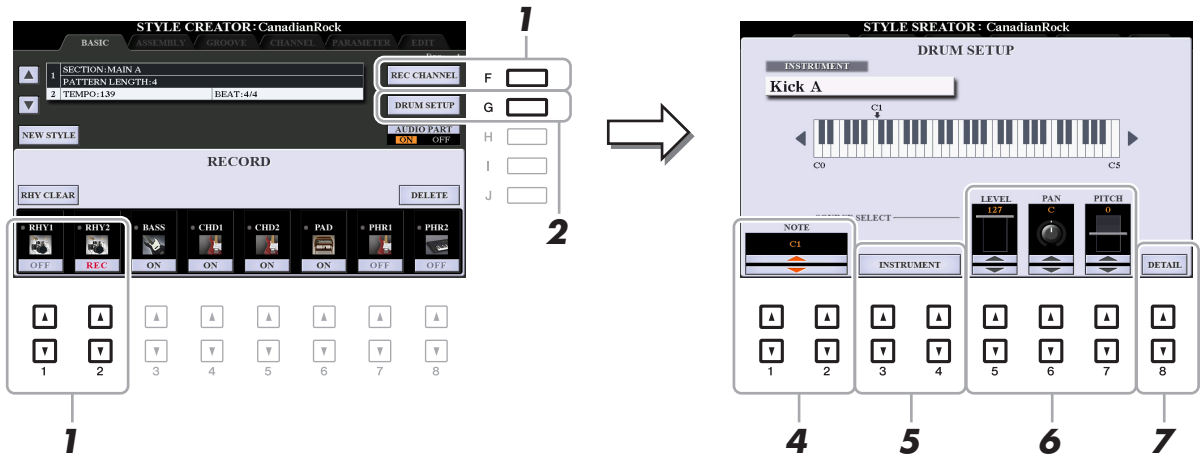

- 2 Press the [G] (DRUM SETUP) button to call up the **DRUM SETUP** window.
- 3 If necessary, press the **STYLE CONTROL [START/STOP]** button to start playback of the rhythm part.

The sounds played back are indicated on the display keyboard, letting you to check the note to edit.

- 4 Use the [1 ▲▼]/[2 ▲▼] (NOTE) buttons to select the note to edit.

NOTE You can also select the note by pressing the note on the keyboard.

- 5 Select the desired instrument to be used.

- 5-1 Use the [3 ▲▼]/[4 ▲▼] (INSTRUMENT) buttons to call up the window to select the instrument.

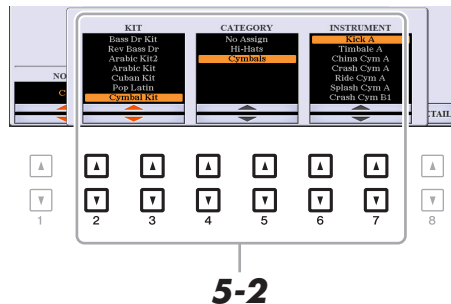

- 5-2 Use the [2 ▲▼]–[7 ▲▼] buttons to select the Kit, Category and instrument in order.

- 5-3 Press the [EXIT] button to close the window.

▶ NEXT PAGE

6 If necessary, set the volume level, pan or pitch by using the [5 ▲▼]–[7 ▲▼] buttons.

7 If necessary, make more detailed settings.

7-1 Press the [8 ▲▼] (DETAIL) button to call up the detailed settings window.

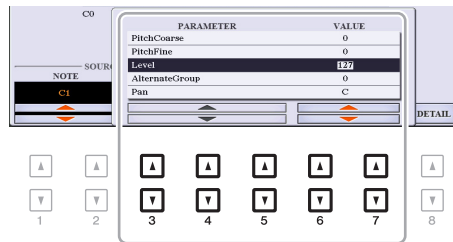

7-2

7-2 Use the [3 ▲▼]–[5 ▲▼] buttons to select the parameter, then use the [6 ▲▼]/ [7 ▲▼] buttons to set the value.

The parameters with “*” in the list below indicates that the settings here affect the settings in step 6.

Pitch Coarse*	For coarse tuning of the pitch in semitone increments.
Pitch Fine*	For fine tuning of the pitch in cent increments. NOTE In musical terms a “cent” is 1/100th of a semitone. (100 cents equal one semitone.)
Level*	For adjusting the volume level.
Alternate Group	Determines the Alternate Group. Any instruments in the same group number cannot sound at the same time. Playing any instrument within a numbered group will immediately stop the sound of any other instrument in the same group of the same number. If this is set to 0, the instruments in the group can sound at the same time.
Pan*	Determines the stereo position.
Reverb Send	For adjusting the reverb depth.
Chorus Send	For adjusting the chorus depth
Variation Send	For adjusting the variation effect (DSP1) depth. When the “Connection” parameter is set to “Insertion” on the Mixing Console display and this rhythm channel is selected as the assign part, this parameter affects as below. <ul style="list-style-type: none"> • When Variation Send is set to 0: No effects are applied to the instrument (Insertion Off). • When Variation Send is set to 1–127: Effects are applied to the instrument (Insertion On).
Key Assign	Determines the Key Assign mode. This parameter is effective only when the kit’s XG parameter “SAME NOTE NUMBER KEY ON ASSIGN” (see the Data List on the website) is set to “INST.” <ul style="list-style-type: none"> • Single: Each successive playing of the same sound results in the previous being cut off or muted. • Multi: Each sound continues to its full decay, even when played successively multiple times.
Rcv Note Off	Determines whether note-off messages are received or not.
Rcv Note On	Determines whether note-on messages are received or not.
Filter Cutoff	Determines the cutoff frequency or effective frequency range of the filter. Higher values result in a brighter sound.

Filter Resonance	Determines the emphasis given to the cutoff frequency (resonance), set in Filter Cutoff above. Higher values result in a more pronounced effect.
EG Attack	Determines how quickly the sound reaches its maximum level after the key is played. The higher the value, the quicker the attack.
EG Decay 1	Determines how quickly the sound reaches its sustain level (a slightly lower level than maximum). The higher the value, the quicker the decay.
EG Decay 2	Determines how quickly the sound decays to silence after the key is released. The higher the value, the quicker the decay.

7-3 Press the [EXIT] button to close the window.

8 Press the [EXIT] button to return to close the DRUM SETUP window.

NOTICE

The edited Style will be lost if you change to another Style or turn off the power to the instrument without carrying out the Save operation (step 7 on [page 31](#)).

Contents

Editing Music Notation (Score) Settings	49
Editing Lyrics/Text Display Settings	52
Using the Auto Accompaniment Features with Song Playback	53
Song Playback Related Parameters (Guide Function, Channel settings, Repeat settings) ...	54
• Keyboard and Vocal Practice Using the Guide Function	55
• Playing Backing Parts with the Performance Assistant Technology	57
Creating/Editing Songs (Song Creator)	58
• Recording Melodies (Step Recording)	59
• Recording Chords (Step Recording)	62
• Selecting the Setup Data to be Recorded to the Top Position of the Song	65
• Re-recording a Specific Section—Punch In/Out	66
• Editing Channel Events of Existing Song Data	69
• Editing Chord Events, Notes, System Exclusive Events and Lyrics	72

Editing Music Notation (Score) Settings

To view the music notation of the selected Song, press the [SCORE] button. You can change the Score display as desired to suit your personal preferences. The settings here are maintained even when the power is turned off.

NOTE You can save the settings here as a part of a Song by accessing [FUNCTION] → TAB [▶] MENU 2 → [B] SONG CREATOR → TAB [◀][▶] SETUP. See page 65.

NOTE Depending on the particular commercially available Song, Score display may not be possible.

NOTE The score of an audio file cannot be shown because the score is created based only on MIDI events.

The screenshot shows the 'SCORE: Ode To Joy' screen with the following elements:

- Header: TEMPO ♩=99, SCORE: Ode To Joy, PAGE 1/2
- Musical notation: Four staves of music. The first staff is labeled 'INTRODUCTION', the second 'THEME', and the fourth 'ENDING'.
- Settings bar: LEFT OFF, RIGHT ON, CHORD OFF, LYRICS ON, NOTE OFF, COLOR OFF, SIZE SMALL, SET UP
- Control buttons: A grid of 8 buttons labeled 1 through 8. Buttons 1-4 have an upward arrow (▲), buttons 5-8 have a downward arrow (▼).

NEXT PAGE

[1 ▲▼]	LEFT ON/ OFF	Enables/disables display of the left-hand notation. Depending on other settings, this parameter may be unavailable and may appear grayed out. If this is the case, go to the detailed setting display (see below) and set the LEFT CH parameter to any channel except “AUTO.” Or, go to the display [FUNCTION] → TAB [◀] MENU 1 → [H] SONG SETTING → TAB [◀] GUIDE/CHANNEL and set the TRACK 2 parameter to any channel except “OFF” (page 54). RIGHT (next parameter) and LEFT cannot be turned off at the same time.
[2 ▲▼]	RIGHT ON/ OFF	Enables/disables display of the right-hand notation. RIGHT and LEFT (above) cannot be turned off at the same time.
[3 ▲▼]	CHORD ON/ OFF	Enables/disables display of the chords. If the selected Song does not contain chord data, chords are not displayed.
[4 ▲▼]	LYRICS ON/ OFF	Enables/disables display of the lyrics. If the selected Song does not contain lyric data, lyrics are not displayed. When the Song contains Pedal events, pressing these buttons can display the Pedal events, instead of displaying Lyrics.
[5 ▲▼]	NOTE ON/ OFF	Enables/disables display of the note name (pitch). The note name is indicated at the left of the note. When the space between the notes is too small, the indication may be moved to the top left of the note. When the Song contains Fingering events, pressing these buttons can display the fingering, instead of displaying note names.
[6 ▲▼]	COLOR ON/ OFF	When this is set to ON, the notes in the display appear in color (C: red, D: yellow, E: green, F: orange, G: blue, A: purple, and B: gray).
[7 ▲▼]	SIZE	Determines the display zoom level of the notation.
[8 ▲▼]	SET UP	Calls up the detailed setting display. See below.

Pressing the [8 ▲▼] (SET UP) button calls up the detailed setting display. You can set the view type by using the [1 ▲▼]–[6 ▲▼] buttons, then press the [8 ▲] (OK) button.

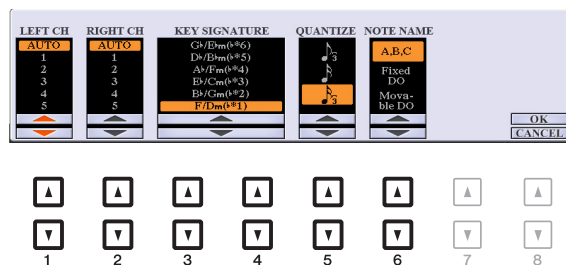

[1 ▲▼]	LEFT CH	Determines which MIDI channel in the Song data is used for the left-hand/right-hand part. This setting returns to AUTO when a different Song is selected.
[2 ▲▼]	RIGHT CH	<p>AUTO: The MIDI channels in the Song data for the right- and left-hand parts are assigned automatically—setting the parts to the same channel as the channel which is specified in the [FUNCTION] → TAB [◀] MENU 1 → [H] SONG SETTING → TAB [◀] GUIDE/CHANNEL (page 54).</p> <p>1–16: Assigns the specified MIDI channel (1–16) to each of the left- and right-hand parts.</p> <p>OFF (Available setting only for LEFT CH): Assigns no channel to the left-hand part. This disables display of the left-hand range.</p>

[3 ▲▼]/ [4 ▲▼]	KEY SIGNATURE	This lets you enter key signature changes in the middle of a Song, at the stopped position. This menu is useful when the selected Song contains no key signature settings for displaying notation.
[5 ▲▼]	QUANTIZE	This gives you control over the note resolution in the notation, letting you shift or correct the timing of all displayed notes so that they line up to a particular note value. Make sure to select the smallest note value used in the Song.
[6 ▲▼]	NOTE NAME	<p>Selects the type of the note name indicated at the left of the note in the notation from among the following three types. The settings here are available when the NOTE ON/OFF parameter above is set to ON.</p> <p>A, B, C: Note names are indicated as letters (C, D, E, F, G, A, B).</p> <p>Fixed DO: Note names are indicated in solfeggio, with the note of C fixed to DO. The notes “C, D, E, F, G, A, B” are always indicated as “Do, Re, Mi, Fa, So, La, Ti” when the language is set to English. Note that the note name indication differs depending on the current language (page 55).</p> <p>Movable DO: Note names are indicated in solfeggio according to the key of the current Song. When a Song in the key of D Major is selected, for example, the notes “D, E, F#, G, A, B, C#” are indicated as “Do, Re, Mi, Fa, Sol, La, Ti” when the language is set to English. Note that the note name indication differs depending on the current language (page 55).</p>

Editing Lyrics/Text Display Settings

To view the lyrics of the selected Song or the text, press the [LYRICS/TEXT] button. You can change the Lyrics/Text display settings, such as background color, as desired.

NOTE When the lyrics are garbled or unreadable, you may need to change the Lyrics Language setting from the [FUNCTION] → TAB [◀] MENU 1 → [H] SONG SETTING → TAB [▶] OTHERS (page 55).

NOTE When you create a text file on a computer, make sure to enter line breaks manually. This is necessary because the auto line breaks cannot be entered on this instrument. If a sentence extends beyond the display and cannot be shown properly, revise the text data by manually entering appropriate line breaks.

Lyrics display
The lyrics in the Song data are shown.

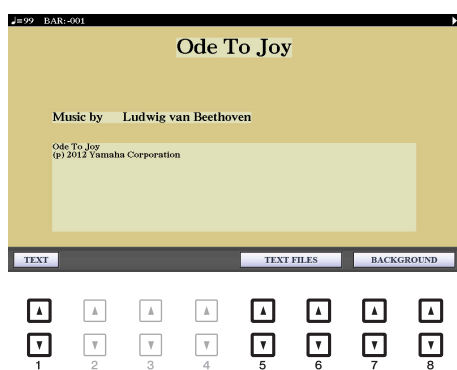

Text display
The texts created on a computer are shown.

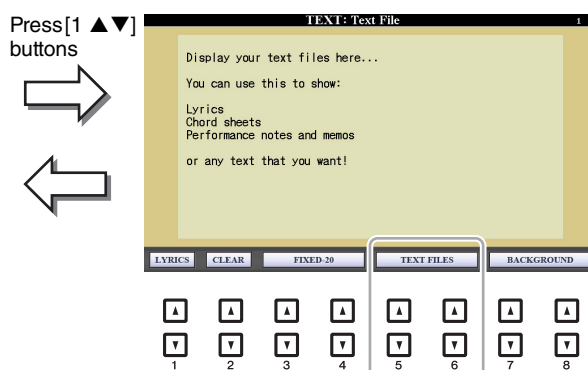

Press [1 ▲▼] buttons



Press the [5 ▲▼]/[6 ▲▼] button to actually call up desired text file.

[1 ▲▼]	TEXT/LYRICS	Switches the screen between the Lyrics display (lyrics data in the Song is shown) and the Text display (a text file selected via the [5 ▲▼]/[6 ▲▼] buttons).
[2 ▲▼]	CLEAR (only when a text file is selected)	Clears the text from the display. This operation does not delete the text file itself, but results in no text file being selected. If you want to restore the text indication, select the text file again via the [5 ▲▼]/[6 ▲▼] buttons.
[3 ▲▼]/ [4 ▲▼]	FIXED-16–28, PROPORTIONAL- 16–28 (only when a text file is selected)	Determines the text type (fixed or proportional) and font size. Fixed is suitable for displaying lyrics with chord names, since the positions of chord names are “fixed” to the corresponding lyrics. Proportional is suitable for displaying lyrics without chord names or explanatory notes. The numbers 16–28 indicate font sizes.
[5 ▲▼]/ [6 ▲▼]	TEXT FILES	Calls up the text File Selection display. After selecting, press the [EXIT] button to return back to the Lyrics/Text display.
[7 ▲▼]/ [8 ▲▼]	BACKGROUND	Allows changing of the background picture of the Lyrics/Text display. After making the setting, press the [EXIT] button to return back to the Lyrics/Text display. NOTE When the background picture is specified in the Song data, the BACKGROUND setting cannot be changed. NOTE For information on available image files, refer to the MAIN PICTURE parameter on page 130.

Using the Auto Accompaniment Features with Song Playback

When playing back a Song and a Style at the same time, channels 9-16 in the Song data are replaced with Style channels—allowing you to play the accompaniment parts of the Song yourself. Try playing chords along with the Song playback as shown in the instructions below.

- 1** Select a Song.
- 2** Select a Style.
- 3** While holding down the SONG [■] (STOP) button, press the [▶/■] (PLAY/PAUSE) button to enable synchronized start of the Song.

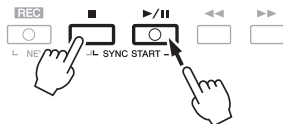

- 4** Press the STYLE CONTROL [ACMP] button to turn on the auto accompaniment function, then press the [SYNC START] button to enable synchronized start of the accompaniment.

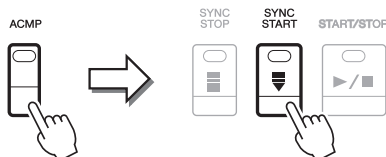

- 5** Press the STYLE CONTROL [START/STOP] button or play chords in the chord section. The Song and Style starts playing. When you play chords, pressing the [SCORE] button and turning CHORD on ([page 49](#)) allows you to see the chord information.

NOTE When playing back a Song and a Style at the same time, the tempo value set in the Song is automatically used.

NOTE The Style Retrigger function ([page 13](#)) cannot be used during Song playback.

When the Song playback is stopped, Style playback is also stopped at the same time.

Song Playback Related Parameters (Guide Function, Channel settings, Repeat settings)

The instrument has a variety of Song playback functions—repeat playback, various guide settings, etc.—which can be accessed in the display below.

Call up the operation display.

[FUNCTION] → TAB [◀] MENU 1 → [H] SONG SETTING → TAB [◀][▶] GUIDE/CHANNEL or OTHERS

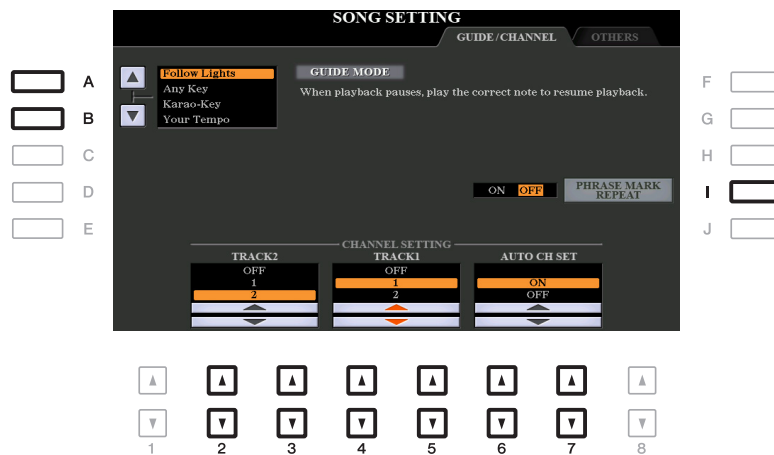

■ GUIDE/CHANNEL Page

[A]/[B]	GUIDE MODE	See page 55 .
[I]	PHRASE MARK REPEAT	This parameter is available only when the current Song contains Phrase Marks, which specify certain locations (of several measures each) in the Song. When this is set to ON, the section corresponding to the Phrase Mark (specified via the SONG [◀◀] (REW) and [▶▶] (FF) buttons) is played back repeatedly. Note that this parameter can be set only when the Song playback is stopped.
[2 ▲▼]/ [3 ▲▼]	TRACK 2	These parameters determine which MIDI channel in the Song data is assigned to the left- or right-hand part of the Guide function and the Song Score function. In addition, the setting here also determines which channels are assigned to the [TR1] (TRACK 1) and [TR2] (TRACK 2) buttons.
[4 ▲▼]/ [5 ▲▼]	TRACK 1	
[6 ▲▼]/ [7 ▲▼]	AUTO CH SET	When set to “ON,” this automatically sets the proper MIDI channels for the Right- and Left hand parts pre-programmed in the commercially available Song data. Normally, this should be set to “ON.”

NEXT PAGE

■ OTHERS Page

[G]	REPEAT MODE	<p>Determines the method of repeat playback.</p> <p>OFF: Plays through the selected Song, then stops.</p> <p>SINGLE: Plays through the selected Song repeatedly.</p> <p>ALL: Continues playback through all the Songs in the specified folder repeatedly.</p> <p>RANDOM: Continues playback at random through all the Songs in the specified folder repeatedly.</p>
[I]	FAST FORWARD TYPE	<p>Determines the fast forward type of when pressing [▶▶] (FF) button during Song playback.</p> <p>JUMP: Pressing [▶▶] button once instantly sets the playback position to the next measure without sounding. Holding [▶▶] button scrolls forward continuously.</p> <p>SCRUB: Pressing and holding [▶▶] plays and sounds the Song at high speed.</p>
[2 ▲▼]/ [3 ▲▼]	LYRICS LANGUAGE	<p>Determines the language displayed in the Lyrics display.</p> <p>AUTO: When the language is specified in the Song data, the lyrics are displayed accordingly. When the language is not specified in the Song data, the lyrics language is regarded as INTERNATIONAL below.</p> <p>INTERNATIONAL: Handles the displayed lyrics as a western language.</p> <p>JAPANESE: Handles the displayed lyrics as Japanese.</p>
[4 ▲▼]/ [5 ▲▼]	QUICK START	<p>On some commercially available Song data, certain settings related to the Song (such as Voice selection, volume, etc.) are recorded to the first measure, before the actual note data. When Quick Start is set to “ON,” the instrument reads all initial non-note data of the Song at the highest possible speed, then automatically slows down to the appropriate tempo at the first note. This allows you to start playback as quickly as possible, with a minimum pause for reading of data.</p>
[6 ▲▼]/ [7 ▲▼]	P.A.T. (Performance Assistant Technology)	See page 57 .

Keyboard and Vocal Practice Using the Guide Function

With the Guide function, the instrument indicates the timing you need to play notes in the Score display for ease in learning. This instrument also features convenient vocal practice tools that let you adjust the timing of Song playback to match your vocal performance.

1 Select the desired Song for practicing the keyboard or singing.

2 Call up the setting display.

[FUNCTION] → TAB [◀] MENU 1 → [H] SONG SETTING → TAB [◀] GUIDE/CHANNEL

3 Use the [A]/[B] buttons to select the desired Guide mode.



Guide modes for keyboard practice

• Follow Lights

When this is selected, Song playback pauses, waiting for you to play the notes correctly. When you play the correct notes, Song playback continues. Follow Lights was developed for the Yamaha Clavinova series. This function is used for practicing purposes, with built-in lamps on the keyboard indicating the notes to be played. Even though the PSR-S970/S770 does not have these lamps, you can use the same function by following the indications in the displayed notation with the Song Score function.

• Any Key

With this function, you can play the melody of a Song just by pressing a single key (any key is OK) in time with the rhythm. Song playback pauses and waits for you to play any key. Simply play a key on the keyboard in time with the music and Song playback continues.

• Your Tempo

The same as Follow Lights, except that Song playback matches the speed at which you play.

Guide mode for singing

• Karao-Key

This function lets you control the Song playback timing with just one finger, while you sing along. This is useful for singing to your own performance. Song playback pauses, waiting for you to sing. Simply play any key on the keyboard (playing the keyboard produces no sound) and Song playback continues.

4 Turn the [GUIDE] button on.



5 Call up the Score display by pressing the [SCORE] button.

6 Press the SONG [▶/||] (PLAY/PAUSE) button to start playback.

Practice playing the keyboard or singing, along with the Guide mode selected in step 3.

7 Press the [■] (STOP) button to stop playback.

NOTE You can save the Guide settings as a part of the Song data (page 65). For Songs to which the Guide settings have been saved, the Guide function will be automatically turned on and the related settings will be recalled when the Song is selected.

Playing Backing Parts with the Performance Assistant Technology

This feature lets you play your own backing parts on the keyboard along with Song playback, and have them sound perfectly appropriate (even though you might be playing wrong notes).

1 Select a Song containing chord data.

The Performance assistant technology is applied only to a Song containing chord data. To confirm whether the selected Song contains chord data or not, return to the Main display then start playback. If the current Song contains chord data, the Main display shows the current chord type. After stopping playback, go to the next step.

2 Call up the operation display.

[FUNCTION] → TAB [◀] MENU 1 → [H] SONG SETTING → TAB[▶] OTHERS

3 Use the [6 ▲]/[7 ▲] buttons to turn “P.A.T.” (performance assistant technology) on.

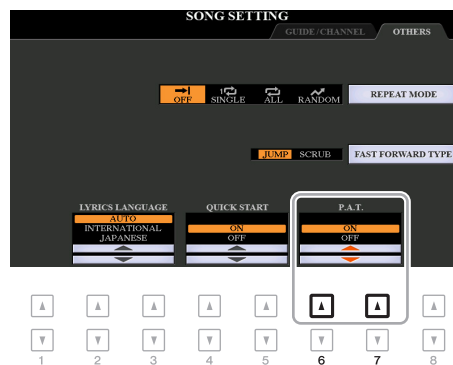

4 Press the SONG [▶/||] (PLAY/PAUSE) button to start playback.

5 Play the keyboard.

Along with Song playback, try playing the bass line with the left hand area while playing various phrases or chords with the right hand area. Even if you do not know what notes should be played, don't worry and play any keys as desired! Only the harmonically “correct” notes matching the current chord are sounded, regardless of the notes you actually play.

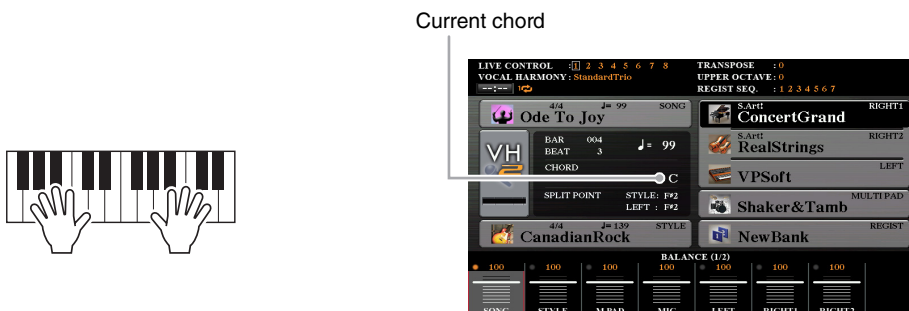

6 Press the [■] (STOP) button to stop playback.

After you finish playing, make sure to turn P.A.T. off.

NOTE Selecting another Song resets P.A.T. to OFF.

Creating/Editing Songs (Song Creator)

The Owner's Manual covers how to create an original Song by recording your keyboard performance (called "Realtime Recording"). This Reference Manual shows how to create an original Song by entering notes one by one (called "Step Recording") and how to improve an already created Song by editing the detailed parameters.

Realtime Recording and Step Recording

When creating a Song, these two Recording methods are available. With Realtime Recording, this instrument records the performance data as it is played. With Step Recording, you can compose your performance by "writing" it down one event at a time.

This chapter primarily covers the instructions for Step Recording.

Song Data Structure

A Song consists of 16 MIDI channels. You can create data of a Song by recording your performance to a specific channel or channels in realtime, or by executing the Step Recording.

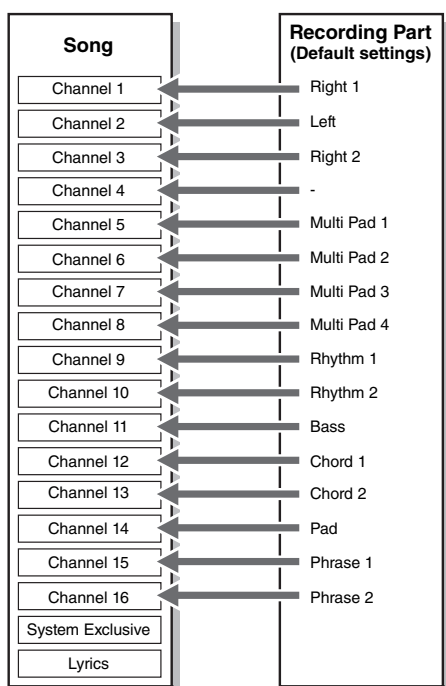

Keyboard Performance

Realtime Recording:

By default, your keyboard performance will be recorded to MIDI channels 1–3.

Step Recording:

Without specifying the keyboard part, you can input the melodies or notes on the music notation sheet one by one to the desired channel.

Multi Pad playback

Realtime Recording:

By default, Multi Pad playback will be recorded to MIDI channels 5–8.

Step Recording:

Multi Pad playback events cannot be input via Step Recording.

Style playback

Realtime Recording:

By default, Style playback will be recorded to MIDI channels 9–16.

Step Recording:

After inputting the Chord change/Section change events, press the [F] (EXPAND) button to actually record the note data to MIDI channels 9–16.

Song Creator Display Structure

The Song Creator display can be called up via [FUNCTION] → TAB [▶] MENU 2 → [B] SONG CREATOR

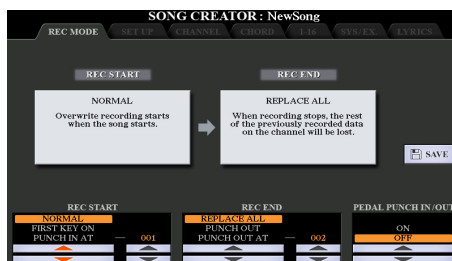

There are seven pages (tabs) in the Song Creator display.

- **REC MODE**..... For re-recording a Song. See [page 66](#).
- **SETUP**..... For selecting the panel setups to be recorded to the top position of the Song. See [page 65](#).
- **CHANNEL**..... For editing Channel events. See [page 69](#).

- **CHORD**For recording chords and Sections with precise timing (page 62) or editing them (page 72).
- **1-16**For recording melodies (Step Recording; see below) or editing the recorded melodies (page 72).
- **SYS/EX**.....For editing System Exclusive events (tempo, time signature, etc.). See page 72.
- **LYRICS**.....For inputting/editing a Song name and lyrics. See page 72.

Recording Melodies (Step Recording)

1 Press the SONG [REC] and SONG [■] (STOP) buttons simultaneously.

A blank Song (“New Song”) is called up for recording.



2 Call up the operation display.

[FUNCTION] → TAB [▶] MENU 2 → [B] SONG CREATOR → TAB [◀][▶] 1-16

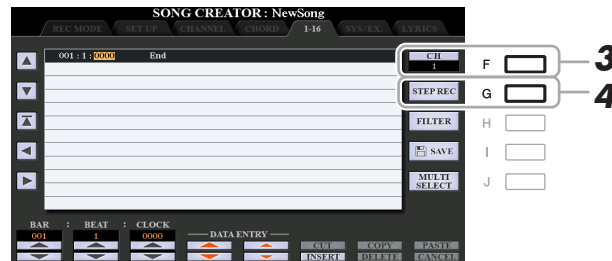





3 Press the [F] button to select the channel for recording.

4 Press the [G] (STEP REC) button to call up the STEP RECORD display.

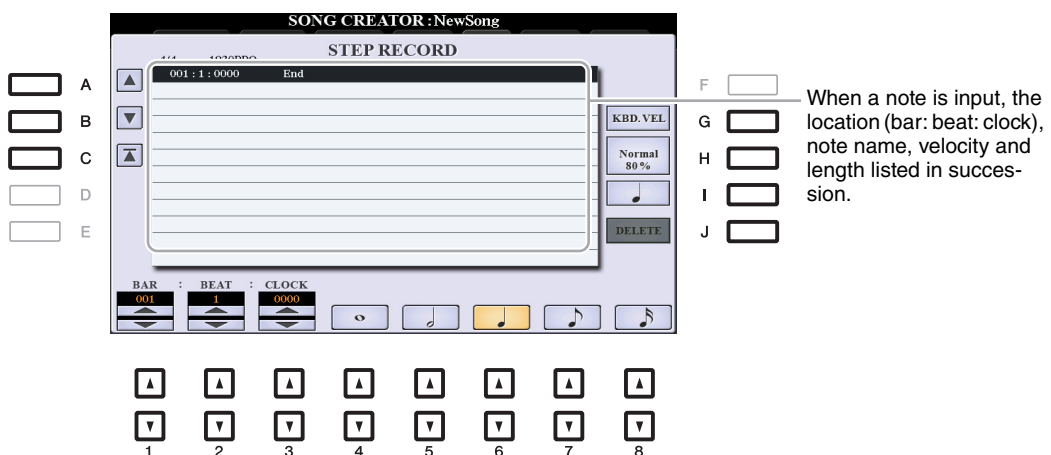
5 Start Step Recording by using the [A]–[J] buttons and [1 ▲▼]–[8 ▲▼] buttons, as well as the keyboard.

Refer to the example on page 61 for specific instructions.



[A]/[B]/ [C]		Moves the cursor in the list.
[G]		Determines the velocity (loudness) of the note to be entered. The velocity value can be specified within a range from 1 to 127. The higher the velocity value, the louder the actual sound. KBD.VEL: Actual resulting velocity fff: 127 ff: 111 f: 95 mf: 79 mp: 63 p: 47 pp: 31 ppp: 15
[H]		Determines the gate time (actual length) of the note to be entered. Normal: 80%  Tenuto: 99%  Staccato: 40%  Staccatissimo: 20%  Manual: The gate time can be set to any desired percentage by using the Data dial.
[I]		Determines the note type to be entered: normal, dotted or triplet.
[J]	DELETE	Deletes the data of the current line.
[1 ▲▼]	BAR	Sets the position of the note to be entered. Note that a quarter note has a resolution of 1,920 clocks.
[2 ▲▼]	BEAT	
[3 ▲▼]	CLOCK	
[4 ▲▼]- [8 ▲▼]		Determines the note length to be entered: whole-note, half-note, quarter-note, eighth-note or sixteenth-note.

- 6** Press the SONG [■] (STOP) button (or press the [C] button) to return to the top of the Song, then hear the newly entered Song by pressing the [▶/■] (PLAY/PAUSE) button.



- 7** Press the [EXIT] button to exit from the Step Recording display.

- 8** Press the [I] (SAVE) button to carry out the Save operation.

For details, refer to “Basic Operations” in the Owner’s Manual.

NOTICE

The recorded Song data will be lost if you select another Song or turn off the power to the instrument without carrying out the Save operation.



Example of Step Recording—Melodies (detailed instructions of step 5 on page 59)

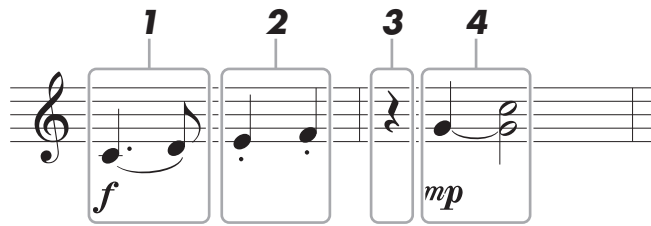

* The numbers shown in the illustration correspond to the following operation step numbers.

In this example, keep in mind that one of the steps involves holding down a key on the keyboard while carrying out the operation.

Before carrying out the instructions below, select the desired Voice on the STEP RECORD display. Note that only the Voice selection and Note input operations are possible during Step Recording.

NOTE Since the actual note length (determined via the Gate Time) may differ from the note length on the notation, the Score of the Song recorded here may be different from the notation above.

1 Enter the first and second notes with a slur.

1-1 Press the [G] button to select “f.”

1-2 Press the [H] button to select “Tenuto.”

1-3 Press the [I] button to select the “dotted” note type.

1-4 Select the dotted quarter-note length by using the [6 ▲ ▼] buttons.

1-5 Play the C3 key.

This enters the first note.

1-6 Press the [I] button to select the “normal” note type.

1-7 Press the [7 ▲ ▼] button to select the eighth-note length.

1-8 Play the D3 key.

This enters the second note.

2 Enter the next notes and apply staccato.

2-1 Press the [H] button to select “Staccato.”

2-2 Press the [6 ▲ ▼] button to select the quarter-note length.

2-3 Play the keys E3 and F3 in order.

This completes the first measure.

3 To enter a quarter-note rest, press the [6 ▲ ▼] button again.

To enter the rest, use the [4 ▲ ▼]–[8 ▲ ▼] buttons. (Press the button once to select the rest value, and once again to actually enter it.) The BAR:BEAT:CLOCK indication lets you confirm that a rest having the specified note length has been entered.

4 Enter the next notes and apply a tie.

4-1 Press the [G] button to select “mp.”

4-2 Press the [H] button to select “Normal.”

4-3 While holding G3 key on the keyboard, press the [6 ▲▼] button.

This operation advances the input position from the current 2nd beat to the next 3rd beat. Do not release the G3 key yet. Keep holding it while executing the following steps.

4-4 While holding the G3 key, press the C4 key.

Do not release the G3 and C4 keys yet. Keep holding the notes while carrying out the following step.



4-5 While holding the keys G3 and C4, press the [5 ▲▼] button.

After pressing the button, release the keys.

This enters the notes G3 and C4 notes have been entered as shown in the notation on the previous page.

Recording Chords (Step Recording)

In Step Recording, you can record the precise change timing of chords and Sections (such as Intro, Main and Ending) of the current Style on the single display. After the operations are finished, the recorded information or events will be converted to the actual MIDI notes or Song data.

1 Press the SONG [REC] and SONG [■] (STOP) buttons simultaneously.

A blank Song (“New Song”) is called up for recording.

NOTE Selecting a blank Song initializes the panel settings.



2 Select the Style you want to use in the Song.

3 Call up the operation display.

[FUNCTION] → TAB [▶] MENU 2 → [B] SONG CREATOR → TAB [◀][▶] CHORD

4 Press the [G] (STEP REC) button to call up the STEP RECORD display.



5 Start Step Recording by using the [A]–[J] buttons and [1 ▲▼]–[8 ▲▼] buttons, as well as the keyboard.

Refer to the example below for specific instructions.

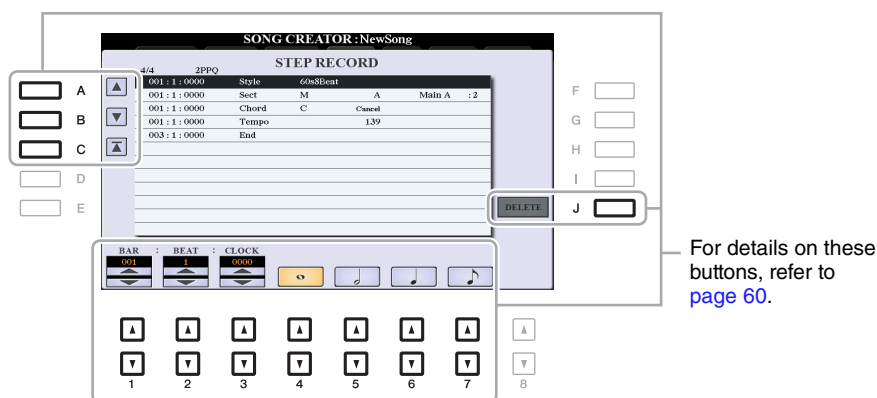

6 Press the SONG [■] (STOP) button (or press the [C] button) to return to the top of the Song, then hear the newly entered Song by pressing the [▶/■] (PLAY/PAUSE) button.



7 Press the [EXIT] button to exit from the Step Recording display.

8 Press the [F] (EXPAND) button to convert the recorded data to the actual MIDI notes (Song data).

9 Press the [I] (SAVE) button to carry out the Save operation.

For details, refer to “Basic Operations” in the Owner’s Manual.

NOTICE

The recorded Song data will be lost if you select another Song or turn off the power to the instrument without carrying out the Save operation.

Example of Step Recording—Chord (detailed instructions of step 5 above)

NOTE This example uses a Style in 4/4 time.

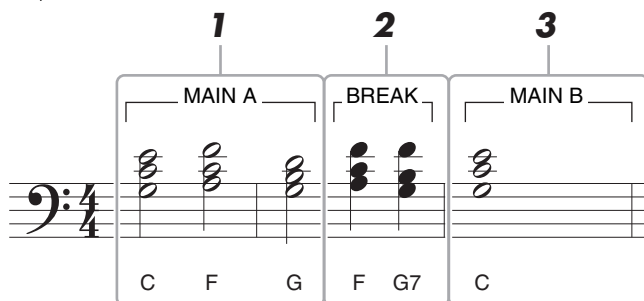

* The numbers shown in the illustration correspond to the following operation step numbers.

Before executing the instructions below, make sure that [AUTO FILL IN] button is turned off since no Fill in is included in the notation example above.

1 Enter the chords for the Main A section.

1-1 Press the STYLE CONTROL MAIN VARIATION [A] button.

1-2 Press the [5 ▲▼] button to select the half-note length.

1-3 Play the chords C, F and G in the chord section of the keyboard.

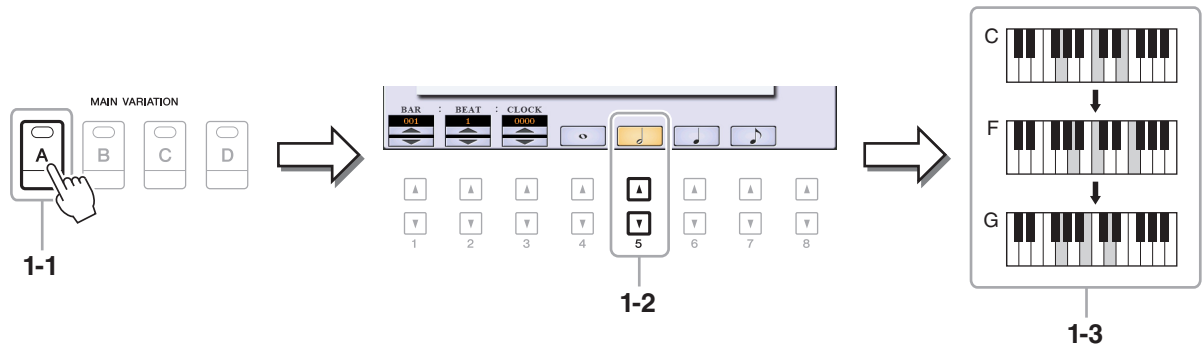

2 Enter the chords for the Break section.

2-1 Press the STYLE CONTROL [BREAK] button.

2-2 Press the [6 ▲▼] button to select the quarter-note length.

2-3 Play the chords F and G7 in the chord section of the keyboard.

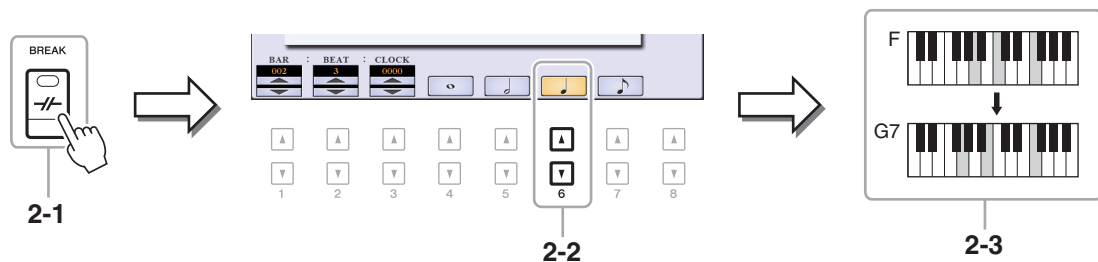

NOTE If you want to record the Fill In Section, turn on the [AUTO FILL IN] button, then press one of the MAIN VARIATION [A]–[D] buttons.

3 Enter the chords for the Main B section.

3-1 Press the STYLE CONTROL MAIN VARIATION [B] button.

3-2 Press the [4 ▲▼] button to select the whole-note length.

3-3 Play the chord C in the chord section of the keyboard.

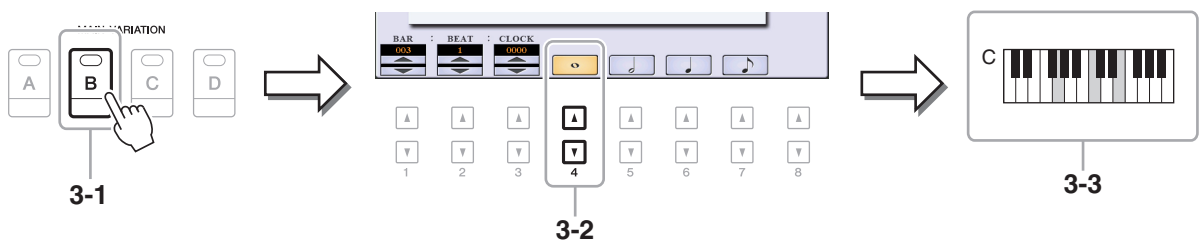

Selecting the Setup Data to be Recorded to the Top Position of the Song

The current settings of the Mixing Console display and other panel settings you made can be recorded to the top position of the Song as Setup data. The panel settings recorded here are automatically recalled when the Song starts.

1 Select the Song to which you want to record the Setup data.

2 Call up the operation display.

[FUNCTION] → TAB [▶] MENU 2 → [B] SONG CREATOR → TAB[◀][▶] SETUP

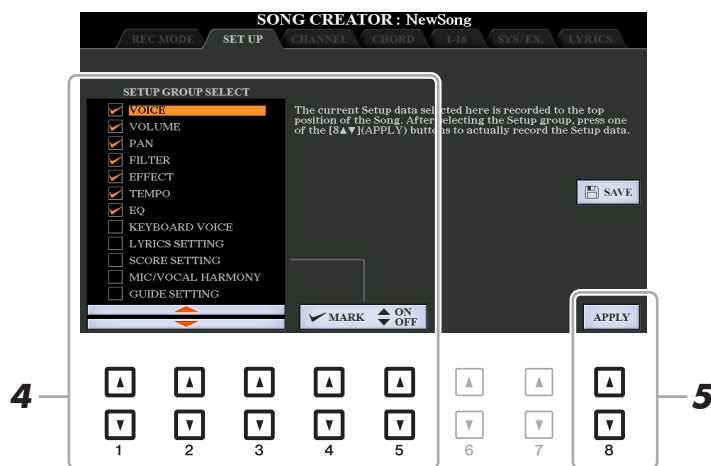

3 Press the SONG [■] (STOP) button to move the Song position to the top of the Song.

4 Determine the Setup data to be recorded.

<p>[1 ▲▼]- [3 ▲▼]</p>	<p>SELECT</p>	<p>Determines which playback features and functions will be automatically called up along with the selected Song. The items selected here can be recorded only to the top position of the Song, except for the KEYBOARD VOICE.</p> <p>VOICE, VOLUME, PAN, FILTER, EFFECT, TEMPO, EQ: Records the tempo setting and all settings made from the Mixing Console.</p> <p>KEYBOARD VOICE: Records the panel settings, including the Voice selection of the keyboard parts (RIGHT 1, 2, and LEFT) and their on/off status. Panel settings recorded here are same as the ones memorized to the One Touch Setting. This can be recorded at any point in a Song, letting you change Voices in the middle of a Song.</p> <p>LYRICS SETTING: Records the settings in the Lyrics display.</p> <p>SCORE SETTING: Records the settings in the Score display.</p> <p>MIC/VOCAL HARMONY (PSR-S970), MIC SETTING (PSR-S770): Records the microphone/guitar settings. For details about the parameters, refer to the “Parameter Chart” in the Data List on the website.</p> <p>GUIDE SETTING: Records the settings of the Guide functions including the Guide ON/OFF setting.</p>
---------------------------	---------------	--

[4 ▲]/ [5 ▲]	MARK ON	Add or remove a checkmark to the selected item. Checked items are recorded to the Song.
[4 ▼]/ [5 ▼]	MARK OFF	

- Press the [8 ▲▼] (APPLY) button to record the data.
- Press the [I] (SAVE) button to carry out the Save operation.

For details, refer to “Basic Operations” in the Owner’s Manual.

NOTICE

The edited Song data will be lost if you select another Song or turn off the power to the instrument without carrying out the Save operation.

Re-recording a Specific Section—Punch In/Out

When re-recording a specific section of an already-recorded Song, use the Punch IN/OUT function. In this method, only the data between the Punch In point and the Punch Out point is overwritten with the newly recorded data. Keep in mind that the notes before and after the Punch In/Out points are not recorded over, although you will hear them play back normally to guide you in the Punch In/Out timing.

NOTE The Style Retrigger function (page 13) cannot be used when recording over existing data (overdubbing).

- Select the desired Song for re-recording.
- Call up the operation display.
[FUNCTION] → TAB [▶] MENU 2 → [B] SONG CREATOR → TAB [◀] REC MODE
- Determine the settings for recording.

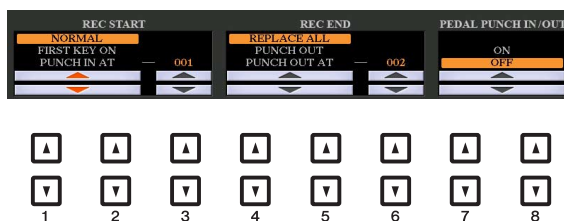

[1 ▲▼]– [3 ▲▼]	REC START (Punch In)	<p>Determines the Punch In timing.</p> <p>NORMAL: Overwrite recording starts when the Song playback is started via the SONG [▶/] (PLAY/PAUSE) button or when you play the keyboard in the Synchro Standby mode.</p> <p>FIRST KEY ON: The Song plays back normally, then starts overwrite recording as soon as you play the keyboard.</p> <p>PUNCH IN AT: The Song plays back normally up to the beginning of the indicated Punch In measure, then starts overwrite recording at that point. You can set the Punch In measure by pressing the [3 ▲▼] button.</p>
-------------------	-------------------------	--



<p>[4 ▲▼]– [6 ▲▼]</p>	<p>REC END (Punch Out)</p>	<p>Determines the Punch Out timing.</p> <p>REPLACE ALL: This deletes all data after the point at which recording is stopped.</p> <p>PUNCH OUT: The Song position at which recording is stopped is regarded as the Punch Out point. This setting maintains all data after the point at which recording is stopped.</p> <p>PUNCH OUT AT: Actual overwrite recording continues until the beginning of the specified Punch Out measure (set with the corresponding display button), at which point recording stops and normal playback continues. This setting maintains all data after the point at which recording is stopped. You can set the Punch Out measure by pressing the [6 ▲▼] buttons.</p>
<p>[7 ▲▼]/ [8 ▲▼]</p>	<p>PEDAL PUNCH IN/OUT</p>	<p>When this is set to ON, you can use Foot Pedal 2 to control the Punch In and Punch Out points. While a Song is playing back, pressing (and holding) Foot Pedal 2 instantly enables Punch In recording, while releasing the pedal stops recording (Punch Out). You can press and release Foot Pedal 2 as often as you want during playback to punch in/out of overwrite recording. Note that the current function assignment of the Foot Pedal 2 is cancelled when the Pedal Punch In/Out function is set to ON.</p> <p>NOTE Pedal Punch In/Out operation may be reversed depending on the particular pedal you've connected to the instrument. If necessary, change the pedal polarity to reverse the control (page 115).</p>

4 While holding the SONG [REC] button, press the desired track button.

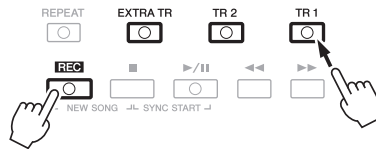

5 Press the SONG [▶/||] (PLAY/PAUSE) button to start Punch In/Out recording.

According to the settings in step 3, play the keyboard between the Punch In and Punch Out points. Refer to the examples of various settings illustrated below.

6 Press the [I] (SAVE) button to carry out the Save operation.

For details, refer to “Basic Operations” in the Owner’s Manual.

NOTICE

The recorded Song data will be lost if you select another Song or turn off the power to the instrument without carrying out the Save operation.

■ Examples of re-recording with various Punch In/Out settings

This instrument features several different ways you use the Punch In/Out function. The illustrations below indicate a variety of situations in which selected measures in an eight-measure phrase are re-recorded.

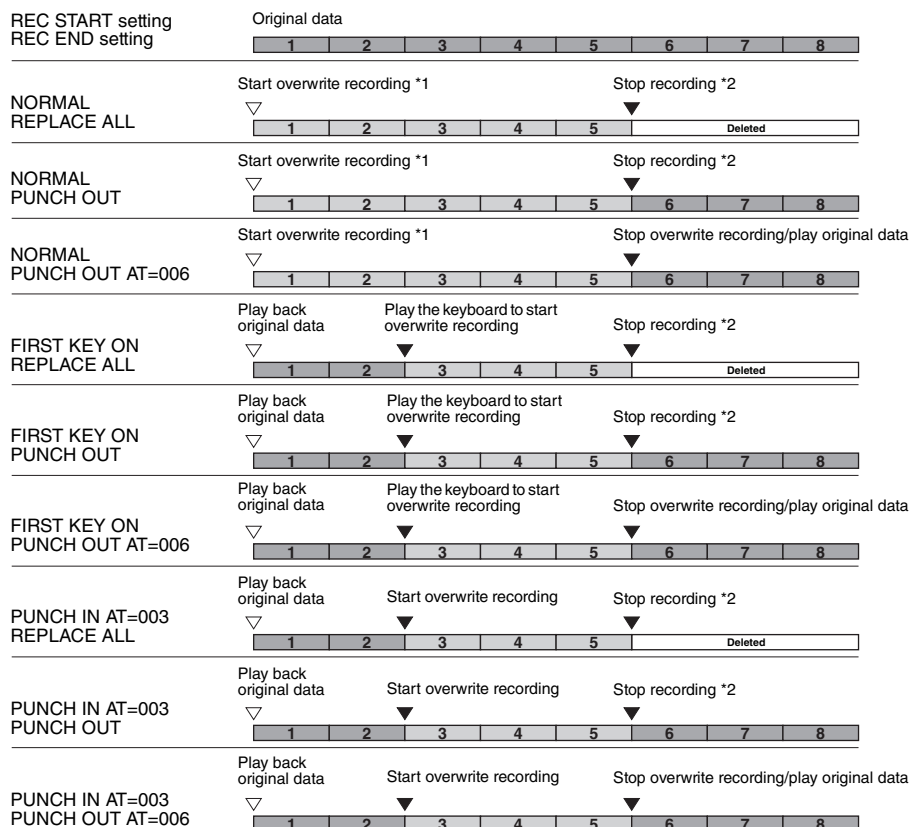

*1 If you want to re-record from the 3rd measure in this setting, move the Song position to the 3rd measure then start recording to avoid overwriting measures 1–2.

*2 To stop recording, press the [REC] button at the end of measure 5.

Previously recorded data
Newly recorded data
Deleted data

Editing Channel Events of Existing Song Data

You can apply various useful functions to already recorded data, such as Quantize and Transpose, on the CHANNEL page.

1 Select a Song to be edited.

2 Call up the operation display.

[FUNCTION] → TAB [▶] MENU 2 → [B] SONG CREATOR → TAB [◀][▶] CHANNEL

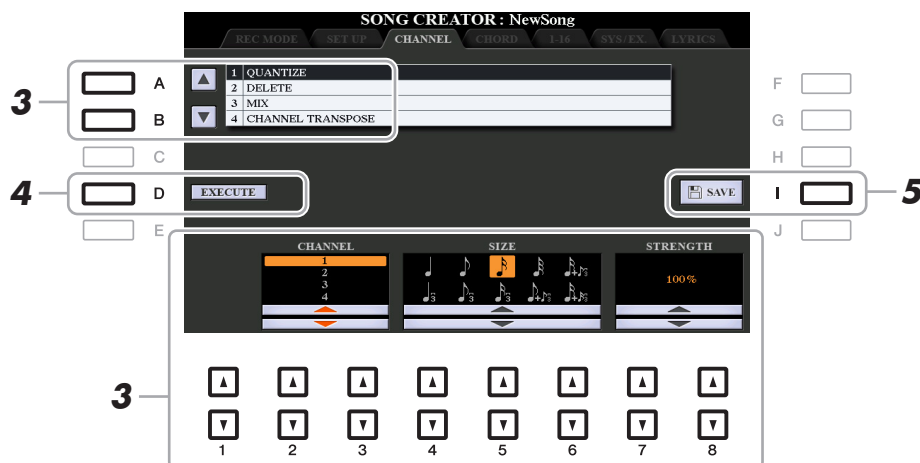

3 Use the [A]/[B] buttons to select the edit menu, then edit the data by using the [1 ▲▼]–[8 ▲▼] buttons.

For details of the edit menu and available settings, see [pages 70–71](#).

4 Press the [D] (EXECUTE) button to carry out the operation for the current display.

After the operation is completed, this button changes to “UNDO,” letting you restore the original data if you are not satisfied with the operation results. The Undo function only has one level; only the previous operation can be undone.

5 Press the [I] (SAVE) button to carry out the Save operation.

For details, refer to “Basic Operations” in the Owner’s Manual.

NOTICE

The edited Song data will be lost if you select another Song or turn off the power to the instrument without carrying out the Save operation.



1 QUANTIZE

The Quantize function allows you to align the timing of all the notes in a channel. For example, if you record the musical phrase shown below, you may not play it with absolute precision, and your performance may have been slightly ahead of or behind the precise timing. Quantize is a convenient way of correcting for this.

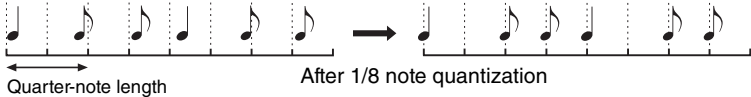
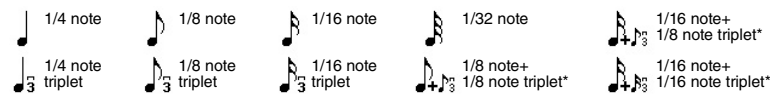
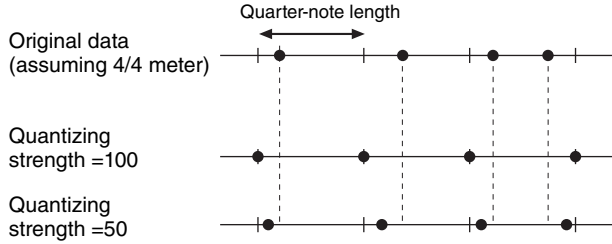

[2 ▲▼]/ [3 ▲▼]	CHANNEL	Determines which MIDI channel in the Song data is to be quantized.
[4 ▲▼]- [6 ▲▼]	SIZE	<p>Selects the quantize size (resolution). For optimum results, you should set the Quantize size to the shortest note value in the channel. For example, if eighth notes are the shortest in the channel, you should use eighth note as the Quantize size.</p>  <p>Settings:</p>  <p>The three Quantize settings marked with asterisks (*) are exceptionally convenient, since they allow you to quantize two different note values at the same time. For example, when the straight eighth notes and eighth-note triplets are contained in the same channel, if you quantize by the straight eighth notes, all notes in the channel are quantized to straight eighth notes—completely eliminating any triplet feel. However, if you use the eighth note + eighth note triplet setting, both the straight and triplet notes will be quantized correctly.</p>
[7 ▲▼]/ [8 ▲▼]	STRENGTH	<p>Determines how strongly the notes will be quantized. A setting of 100% produces exact timing. If a value less than 100% is selected, notes will be moved toward the specified quantization beats according to the specified percentage. Applying less than 100% quantization lets you preserve some of the “human” feel in the recording.</p> 

2 DELETE

You can delete the data of the specified channel in the Song. Select the channel whose data to be deleted by using the [1 ▲▼]–[8 ▲▼] buttons, then press the [D] (EXECUTE) button to carry out the operation.

3 MIX

This function lets you mix the data of two channels and place the results in a different channel. It also lets you copy the data from one channel to another.

[2 ▲▼]/ [3 ▲▼]	SOURCE 1	Determines the MIDI channel (1–16) to be mixed. All MIDI events of the channel specified here are copied to the destination channel.
[4 ▲▼]/ [5 ▲▼]	SOURCE 2	Determines the MIDI channel (1–16) to be mixed. Only note events of the channel specified here are copied to the destination channel. Besides the values 1–16, there is a “COPY” setting that allows you to copy the data from Source 1 to the destination channel.
[6 ▲▼]/ [7 ▲▼]	DESTINATION	Determines the channel into which the mix or copy results will be placed.

4 CHANNEL TRANSPOSE

This allows you to transpose the recorded data of individual channels up or down by a maximum of two octaves in semitone increments.

NOTE Make sure not to transpose channels 9 and 10. In general, Drum Kits are assigned to these channels. If you transpose the channels of Drum Kits, the instruments assigned to each key will be changed.

[F]	CH 1–8/CH 9–16	Toggles between the two channel displays: Channels 1–8, and Channels 9–16.
[G]	ALL CH	To simultaneously set all channels to the same value, adjust the Channel Transpose for one of the channels while holding down this button.

Editing Chord Events, Notes, System Exclusive Events and Lyrics

You can edit chord events, note events, System Exclusive events and lyrics in the same manner on the corresponding displays: CHORD, 1-16, SYS/EX and LYRICS. These are called “Event List” displays because some events are shown in a list view.

Event List display

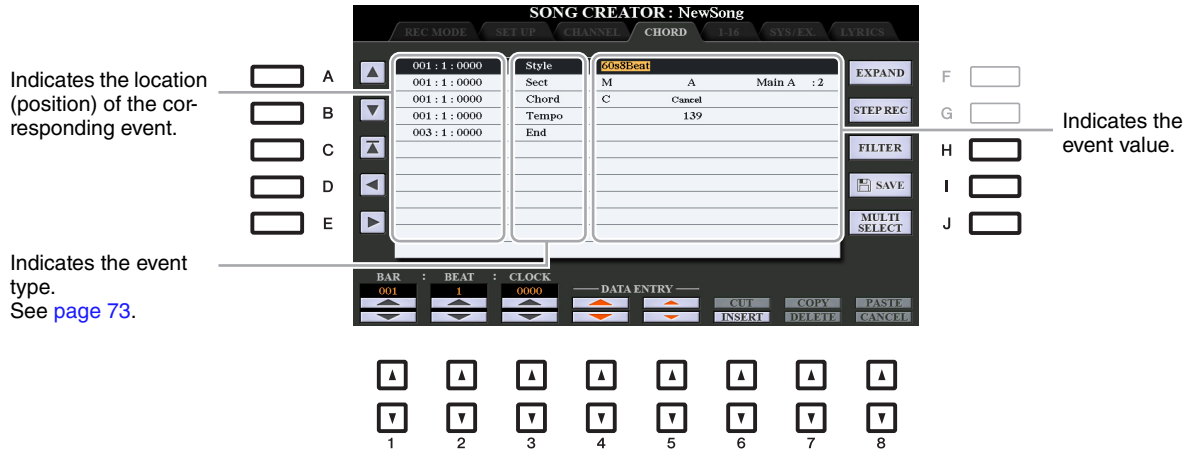

Indicates the location (position) of the corresponding event.

Indicates the event type.
See [page 73](#).

Indicates the event value.

[A]/[B]		Moves the cursor up/down and selects the desired event.
[C]		Moves the cursor to the top (beginning of the Song).
[D]/[E]		Moves the cursor left/right and selects the desired parameter of the highlighted event.
[H]	FILTER	Calls up the Filter display (page 74), letting you select only the events you wish to be shown in the event list.
[I]	SAVE	Press to save the edited Song.
[J]	MULTI SELECT	Holding this button while using the [A]/[B] buttons lets you select multiple events.
[1 ▲▼]	BAR	Determines the position (bar/beat/clock) of the data. One clock is equal to 1/1920th of a quarter note.
[2 ▲▼]	BEAT	
[3 ▲▼]	CLOCK	
[4 ▲▼]/ [5 ▲▼]	DATA ENTRY	Adjusts the event value. For coarse adjustment, use the [4 ▲▼] buttons. For fine adjustment, use the [5 ▲▼] buttons or the Data dial.
[6 ▲]	CUT	Carries out the cut/copy/delete/paste operation.
[7 ▲]	COPY	
[7 ▼]	DELETE	
[8 ▲]	PASTE	
[6 ▼]	INSERT	Adds a new event.
[8 ▼]	CANCEL	Cancels editing and restores the original value.

NOTE After you edit events in the CHORD display, press the [F] (EXPAND) button to convert the data into Song data.

NOTE Chord section data recorded with Realtime Recording cannot be indicated and edited on this display.

■ Chord Events (CHORD Page)

Style	Style
Tempo	Tempo
Chord	Chord root, Chord type, On Bass Chord
Sect	Style Section (Intro, Main, Fill In, Break, Ending)
OnOff	On/off status for each part (channel) of the Accompaniment Style
CH.Vol	Volume for each part (channel) of the Accompaniment Style
S.Vol	Overall volume of the Accompaniment Style

■ Note Events (1-16 Page)

Note	An individual note within a Song. Includes the note number which corresponds to the key which was played, plus a velocity value based on how hard the key is played, and the gate time value (the length of a note).
Ctrl (Control Change)	Settings for controlling the Voice, such as volume, pan, filter and effect depth (edited via the Mixing Console described in chapter 8), etc.
Prog (Program Change)	MIDI program change number for selecting a Voice.
P.Bnd (Pitch Bend)	Data for changing the pitch of a Voice continuously. This event is generated by controlling the [PITCH BEND] wheel.
A.T. (Aftertouch)	This event is generated when pressure is applied to a key after the note is played. Note that the keyboard of this instrument does not feature Aftertouch.

■ System Exclusive Events (SYS/EX. Page)

ScBar (Score Start Bar)	Determines the top measure of a Song.
Tempo	Determines the tempo value.
Time (Time signature)	Determines the time signature.
Key (Key signature)	Determines the key signature, as well as the major/minor setting, for the music score shown on the display.
XGPrm (XG parameters)	Allows you to make various detailed changes to the XG parameters. For details, refer to “MIDI Data Format” in the Data List on the website.
SYS/EX. (System Exclusive)	Displays the System Exclusive data in the Song. Keep in mind that you cannot create new data or change the contents of the data here; however, you can delete, cut, copy, and paste the data.
Meta (Meta event)	Displays the SMF meta events in the Song. Keep in mind that you cannot create new data or change the contents of the data here; however, you can delete, cut, copy, and paste the data.

■ Lyrics Events (LYRICS Page)

Name	Allows you to enter the Song name.
Lyrics	Allows you to enter lyrics.
Code	CR: Enters a line break in the lyrics text. LF: Clears the currently displayed lyrics and displays the next set of lyrics.

Displaying Specific Types of Events

In the Event List displays, various types of events are shown. It may sometimes be difficult to pinpoint the ones you want to edit. This is where the Filter function comes in handy. It lets you determine which event types will be shown in the Event List displays.

- 1 Press the [H] (FILTER) button in the CHORD, 1-16, SYS/EX. or LYRICS displays.
- 2 Checkmark the desired item to be displayed.

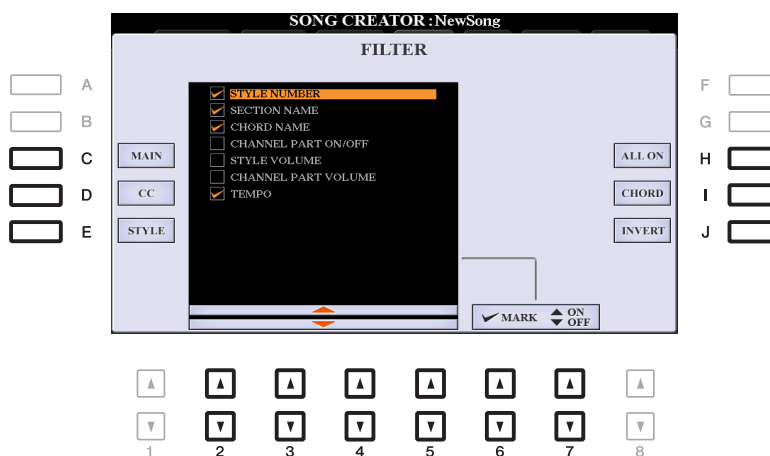

[C]	MAIN	Displays all main types of events.
[D]	CC	Displays all specific Control Change message events.
[E]	STYLE	Displays all types of Style playback related events.
[H]	ALL ON	Checkmarks all event types.
[I]	NOTE/ALL OFF/CHORD	“NOTE” (shown when [C] (MAIN) is on) selects only the NOTE data. “CHORD” (shown when [E] (STYLE) is on) selects only the CHORD data. “ALL OFF” (shown when [D] (CC) is on) removes all checkmarks.
[J]	INVERT	Reverses the checkmark settings for all boxes. In other words, this enters checkmarks to all boxes that were previously unchecked and vice versa.
[2 ▲▼]- [5 ▲▼]		Select and event type to be checked or unchecked.
[6 ▲]/ [7 ▲]	MARK ON	Enters/removes the checkmark for the selected event type. The checked event types can be shown on the CHORD, 1-16, SYS/EX. or LYRICS page.
[6 ▼]/ [7 ▼]	MARK OFF	

- 3 Press the [EXIT] button to return to the Event List display in which only unfiltered Events are shown.

This function is fully explained in the Owner's Manual. Refer to the corresponding chapter in the Owner's Manual.

Multi Pads

Contents

Creating Multi Pads (Multi Pad Creator)	75
• Multi Pad—Realtime Recording via MIDI	75
• Multi Pad—Step Recording via MIDI	77
Editing Multi Pads	77

Creating Multi Pads (Multi Pad Creator)

This feature lets you create your original Multi Pad phrases, and also allows you to edit existing Multi Pad phrases to create your own. As with Song Creator, Multi Pad Creator features Realtime Recording and Step Recording. However, each Multi Pad consists of only one channel and convenient functions such as Punch In/Out are not available.

Multi Pad—Realtime Recording via MIDI

Before starting operation, note the following points:

- Since only the RIGHT 1 part performance will be recorded as Multi Pad phrases, you should select the desired Voice for the RIGHT 1 part beforehand.
- The Super Articulation Voices and the Organ Flutes Voices cannot be used for Multi Pad Recording. If one of these Voices is set for RIGHT 1 part, it will be replaced with the Grand Piano Voice when recording.
- Since recording can be done along with and synchronized to Style playback, you should select the desired Style beforehand. However, keep in mind that the Style is not recorded.

1 If you want to create a new Multi Pad in the existing Bank, select the desired Multi Pad Bank via the MULTI PAD CONTROL [SELECT] button.

If you want to create a new Multi Pad in an empty new Bank, this step is unnecessary.



2 Call up the operation display.

[FUNCTION] → TAB [▶] MENU 2 → [C] MULTI PAD CREATOR → TAB [◀] RECORD

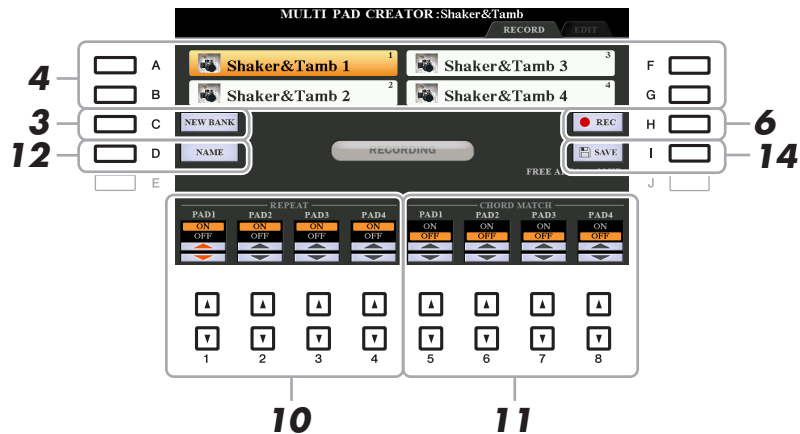

3 If you want to create a new Multi Pad in an empty new Bank, press the [C] (NEW BANK) button.

4 Select a particular Multi Pad for recording by pressing the corresponding [A], [B], [F] and [G] button.

5 If necessary, select the desired Voice with the VOICE category selection buttons.

After selecting the Voice, press the [EXIT] button to return to the previous display.

6 Press the [H] (REC) button to enter recording standby status for the Multi Pad selected in step 4.

7 Play the keyboard to start recording.

To ensure that your recording will be in sync with the tempo, press the [METRONOME] button to turn on the metronome.

If you want to insert silence before the actual phrase, press the STYLE CONTROL [START/STOP] to start both the Recording and rhythm playback (of the current Style). Keep in mind that the rhythm part of the current Style plays back during recording although it is not recorded.

Recommended notes for the Chord Match phrase

If you intend to create a Chord Match phrase, use the notes of C, D, E, G, A and B, or in other words, play the phrase in the key of C major. This ensures that the phrase will stay harmonically constant and match whichever chord you play in the left hand section of the keyboard.

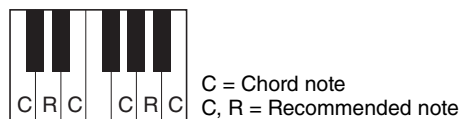

8 Stop recording.

Press the [H] (STOP) button or the panel MULTI PAD CONTROL [STOP] button or the STYLE CONTROL [START/STOP] button to stop recording when you've finished playing the phrase.

9 Listen back to your newly recorded phrase, by pressing the appropriate MULTI PAD button, [1]–[4]. To re-record the phrase, repeat steps 6–8.

10 Turn the Repeat parameter of each pad On or Off by using the [1 ▲▼]–[4 ▲▼] buttons.

If the Repeat parameter is on for the selected pad, playback of the corresponding pad will continue until the MULTI PAD CONTROL [STOP] button is pressed. When you press a Multi Pad for which Repeat is turned on during Song or Style playback, playback will start and repeat in sync with the beat.

If the Repeat parameter is off for the selected pad, playback will end automatically as soon as the end of the phrase is reached.



11 Turn Chord Match of each pad On or Off by using the [5 ▲▼]–[8 ▲▼] buttons.

If the Chord Match parameter is on for the selected pad, the corresponding pad is played back according to the chord specified in the chord section of the keyboard generated by turning [ACMP] on, or specified in the LEFT part of the keyboard generated by turning [LEFT] on (when turning the [ACMP] off).

12 Press the [D] (NAME) button, then enter the desired name for each Multi Pad.

13 If you want to record other Multi Pads, repeat steps 4–12.

14 Press the [I] (SAVE) button to save the Multi Pad, then save the Multi Pad data as a Bank containing a set of four Pads.

NOTICE

The edited Multi Pad data will be lost if you select another Multi Pad Bank or turn off the power to the instrument without carrying out the Save operation.

Multi Pad—Step Recording via MIDI

Step Recording can be carried out in the EDIT page. After selecting a Multi Pad in step 4 on [page 76](#), press the TAB [▶] button to select the EDIT page.

The EDIT page indicates the Event list, which lets you record notes with absolutely precise timing. This Step Recording procedure is essentially the same as that for Song Recording ([pages 59–62](#)), with the exception of the points listed below:

- There is no LCD button for selecting channels, since Multi Pads contain data for only a single channel.
- In the Multi Pad Creator, only channel events and System Exclusive messages can be entered. Chord and Lyrics events are not available. You can switch between the two types of Event Lists by pressing the [F] button.

Editing Multi Pads

You can manage (rename, copy, paste and delete) your created Multi Pad Bank and each of the Multi Pads belonging to the Bank. For instructions on managing the Multi Pad Bank file, refer to “Basic Operations” in the Owner’s Manual. This section covers how to manage each Multi Pad.

1 Select the Multi Pad Bank containing the Multi Pad to be edited.

Press the MULTI PAD CONTROL [SELECT] button to call up the Multi Pad Bank Selection display, use the TAB [◀][▶] buttons to call up “PRESET,” “USER” or “USB” (when USB flash drive is connected), then use the [A]–[J] buttons to select the desired Multi Pad Bank.

NOTE If you select a Preset Multi Pad Bank then edit the Multi Pads, save your edits to “USER” or “USB” (when USB flash drive is connected) as a User Bank.

2 Press the [7 ▼] (EDIT) button of MENU 1 to call up the MULTI PAD EDIT display.

3 Select a particular Multi Pad to be edited by pressing any of the [A], [B], [F] and [G] buttons.



NEXT PAGE

4 Edit the selected Pad.

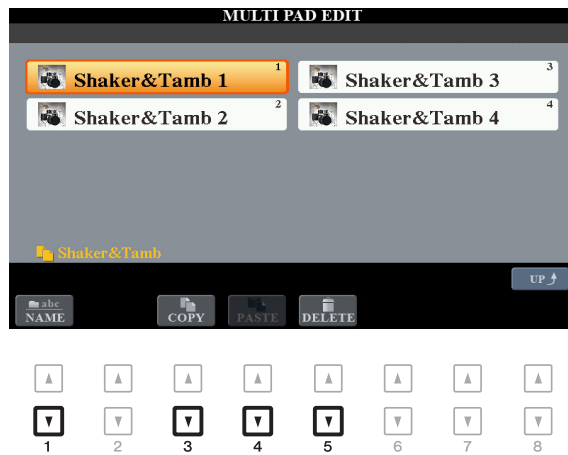

[1 ▼]	NAME	Changes the name of each Multi Pad.
[3 ▼]	COPY	Copies the Multi Pad(s). See below.
[4 ▼]	PASTE	Pastes the Multi Pad(s) copied by the [3 ▼] button.
[5 ▼]	DELETE	Deletes the selected Multi Pads.

5

Copying the Multi Pad

- 1** Press the [3 ▼] (COPY) button in step 4 above.
- 2** Select the Multi Pads to be copied by using the [A], [B], [F] and [G] buttons, then press the [7 ▼] (OK) button.
The selected Multi Pad(s) is copied to the clipboard.
- 3** Select the destination location by using the [A], [B], [F] and [G] buttons. If you want to copy the selected Pad(s) to another bank, press the [8 ▲] (UP) button to call up the Multi Pad Bank Selection display, select the desired bank, press the [7 ▼] (EDIT) button of MENU 1, then select the destination.
- 4** Press the [4 ▼] (PASTE) button to carry out the Copy operation.

5 Save the current Bank containing the edited Multi Pads.

Press the [8 ▲] button to call up the confirmation window, press the [F] (YES) button to call up the USER page, then press the [6 ▼] (SAVE) button to carry out the Save operation. For details, refer to “Basic Operations” in the Owner’s Manual.

Contents

Creating a Set of Favorite Records	79
Editing Records	80
• Deleting the Record	81
Saving the Records as a Single File	81
• Calling up the Records from a Music Finder file	82

Creating a Set of Favorite Records

Even though the Search function lets you efficiently look for Music Finder Records, you may want to create a custom “folder” of your favorite Records—so you can quickly call up the panel settings, song data and Style data you use frequently.

- 1 Select the desired Record from the MUSIC FINDER display.
- 2 Press the [H] (ADD TO FAVORITE) button, then press the [G] (YES) button to add the selected Record to the FAVORITE page.

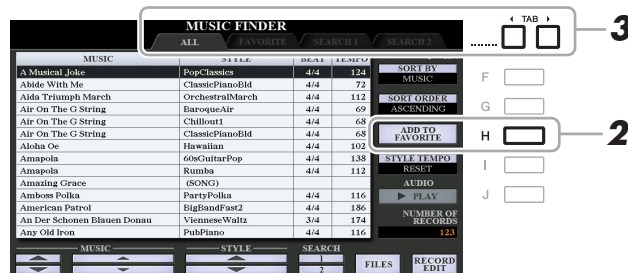

- 3 Select the FAVORITE page by using the TAB [◀][▶] buttons, and check to see if the Record has been added.

As with the ALL page, you can select the Record in the FAVORITE page then start your performance.

Deleting Records from the FAVORITE Page

- 1 Select the Record you want to delete from the FAVORITE page.
- 2 Press the [H] (DELETE FROM FAVORITE) button, then press the [G] (YES) button to actually delete the Record.

Editing Records

You can create your original Record by editing an existing Record. Your edits can be replaced with those of the current Record, or can be saved as a new separate Record.

- 1 Select the desired Record to be edited in the MUSIC FINDER display.
- 2 Press the [8 ▲▼] (RECORD EDIT) button to call up the EDIT display.
- 3 Edit the Record.

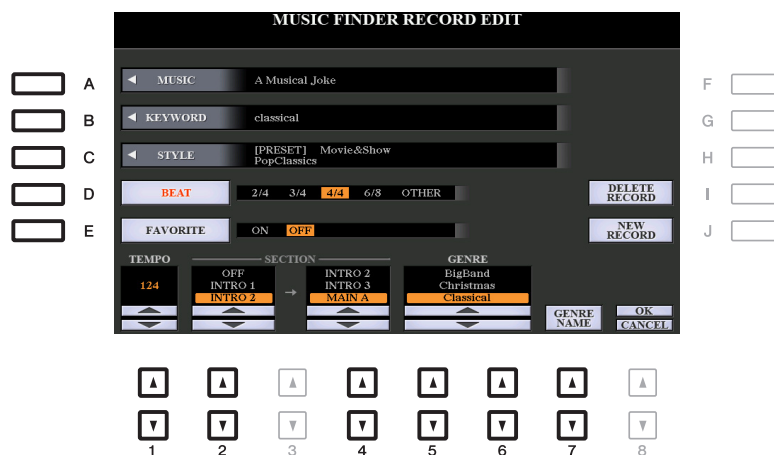

[A]	MUSIC	For entering the music title. Pressing the [A] button calls up the display for entering the music title.
[B]	KEYWORD	For entering the keyword to be used when executing the Search operation. Pressing the [B] button calls up the display for entering the keyword.
[C]	STYLE/SONG/ AUDIO	Changes the Style. Pressing the [C] button calls up the Style Selection display. After selecting the desired Style, press the [EXIT] button to return back to the EDIT display. For SONG or AUDIO Records, this field cannot be edited.
[D]	BEAT	Changes the beat (time signature) of the Record for search purposes. For SONG or AUDIO Records, this field cannot be edited. NOTE Keep in mind that the Beat setting made here is only for the Music Finder search function; this does not affect the actual Beat setting of the Style itself.
[E]	FAVORITE	Selects whether the edited Record is added to the FAVORITE page or not.
[1 ▲▼]	TEMPO	Changes the Tempo. For SONG or AUDIO Records, this field cannot be edited.
[2 ▲▼] [4 ▲▼]	SECTION	Selects the sections of Style that are called up as a set when the Record is selected. You can start the Record with the section selected by the [2 ▲▼] buttons. When the section finishes, Style playback automatically shifts to the section selected by the [4 ▲▼] buttons. For SONG or AUDIO Records, this field cannot be edited.
[5 ▲▼]/ [6 ▲▼]	GENRE	Selects the desired genre.
[7 ▲▼]	GENRE NAME	Creates a new genre.

To cancel and quit the Edit operation, press the [8 ▼] (CANCEL) button.



4 Save the edited Record.

When creating a new Record

Press the [J] (NEW RECORD) button. The Record is added to the ALL page.

When overwriting an existing Record

Press the [8 ▲] (OK) button.

Deleting the Record

By carrying out the Delete operation, the Record is deleted from all pages (ALL, FAVORITE and SEARCH 1/2).

1 Select the Record to be deleted from the MUSIC FINDER display.

2 Press the [8 ▲▼] (RECORD EDIT) button to call up the EDIT display.

3 Press the [I] (DELETE RECORD) button.

To cancel the Delete operation and return to the MUSIC FINDER display in step 1, press [H] (NO); to return to the EDIT display in step 2, press [I] (CANCEL).

4 Press the [G] (YES) button to delete the current Record.

Saving the Records as a Single File

The Music Finder feature handles all the Records including the presets and additionally created Records as a single file. Keep in mind that individual Records (panel settings, Song, audio and Style files) cannot be handled as separate files.

1 Press the [7 ▲▼] (FILES) button in the MUSIC FINDER display to call up the File Selection display.

2 Press the TAB [◀][▶] buttons to select the location for saving (USER/USB).

3 Press the [6 ▼] (SAVE) button.

The Character Entry window is called up. If necessary, rename the file. For instructions, refer to “Basic Operations” in the Owner’s Manual.

4 Press the [8 ▲] (OK) button to save the file.

All Records are saved together as a single Music Finder file.

Calling up the Records from a Music Finder file

By selecting a Music Finder file, you can recall the Records saved to the USER or USB drive as a file.

- 1** Press the [7 ▲▼] (FILES) button in the MUSIC FINDER display to call up the File Selection display.
- 2** Use the TAB [◀][▶] buttons to select the location to which the file is saved.
- 3** Press the [A]–[J] buttons to select the desired Music Finder file.

A message appears, prompting you to select one of the following options.

[G]	REPLACE	All Music Finder Records currently in the instrument are deleted and replaced with the Records of the selected file. <u>NOTICE</u> Selecting “REPLACE” automatically deletes all your original Records from internal memory. Make sure that all important data has been archived to another location beforehand.
[H]	APPEND	The Records called up are added to the Records currently in the instrument.
[I]	CANCEL	Cancels the file selection operation.

Contents

Editing the Registration Memory	83
Disabling Recall of Specific Items (Freeze)	84
Calling Up Registration Memory Numbers in Order (Registration Sequence)	85
• Saving the Registration Sequence Settings	86
• Using the Registration Sequence	87

Editing the Registration Memory

You can edit (rename and delete) each of Registration Memories contained in the Bank.

1 Select the Registration Memory Bank containing the Registration Memory to be edited.

Press the REGISTRATION BANK [+]/[-] buttons simultaneously to call up the Registration Bank Selection display, then press one of the [A]–[J] buttons to select the desired Bank.

2 Press the [7 ▼] (EDIT) button of MENU 1 to call up the REGISTRATION EDIT display.

3 Select a particular Registration Memory to be edited by pressing any of the [A]–[D] and [F]–[I] buttons.

4 Press the [1 ▼] button to rename or the [5 ▼] button to delete the selected Registration Memory.

For details on the Rename and Delete operations, refer to “Basic Operations” in the Owner’s Manual.

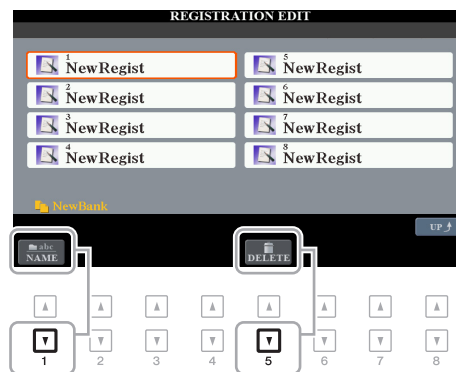

5 Save the current Bank containing the edited Registration Memories.

Press the [8 ▲] (UP) button to call up the Registration Memory Selection display, then press the [6 ▼] (SAVE) button of MENU 2 to carry out the Save operation. For details, refer to “Basic Operations” in the Owner’s Manual.

Disabling Recall of Specific Items (Freeze)

Registration Memory lets you recall all the panel setups you made with a single button press. However, there may be times that you want certain items to remain the same, even when switching Registration Memory setups. When you want to switch the Voice settings but still maintain the Style settings, for example, you can “freeze” only the Style settings and have those Style settings remain, even when you select another Registration Memory number.

1 Call up the operation display.

[FUNCTION] → TAB [◀] MENU 1 → [C] REGIST SEQUENCE/FREEZE → TAB [▶] FREEZE

2 Use the [1 ▲▼]–[3 ▲▼] buttons to select the desired item, then use the [4 ▲▼]/[5 ▲▼] buttons to enter or remove the checkmark.

Items having checkmarks will be frozen when the [FREEZE] button on the panel is turned on.



3 Press the [EXIT] button to exit from the operation display.

NOTICE

Settings in the FREEZE display are automatically saved to the instrument when you exit from this display. However, if you turn the power off without exiting from this display, the settings will be lost.

4 Press the [FREEZE] button on the panel to turn the Freeze function on.

With this operation, you can “freeze” or maintain checkmarked items, even when you select another Registration Memory number. To turn off the Freeze function, press the [FREEZE] button again.

Calling Up Registration Memory Numbers in Order (Registration Sequence)

As convenient as the Registration Memory buttons are, there may be times during a performance when you want to quickly switch between settings. The convenient Registration Sequence function lets you call up the eight setups in any order you specify, by simply using the TAB [◀][▶] buttons (in the Main display) or the pedal as you play.

1 If you intend to use a pedal or pedals to switch the Registration Memory number, connect the optional pedals to the appropriate FOOT PEDAL jacks.

For instructions, refer to chapter 10 of the Owner's Manual.

2 In the REGISTRATION BANK display, select the desired Bank to be programmed.

3 Call up the operation display.

[FUNCTION] → TAB [◀] MENU 1 → [C] REGIST SEQUENCE/FREEZE → TAB [◀]
REGISTRATION SEQUENCE

4 If you use a pedal, specify here how the pedal will be used—to advance or to reverse through the sequence.

Use the [B] or [C] button to select the pedal for advancing or reversing through the Registration Sequence. For example, if two pedals are connected, Pedal 1 is used for advancing while Pedal 2 is used for reversing. Note that the pedal settings here (other than OFF) will take priority over the settings in the FOOT PEDAL display (page 114). If you want to use the pedal for a function other than Registration Sequence, make sure to set this to OFF.

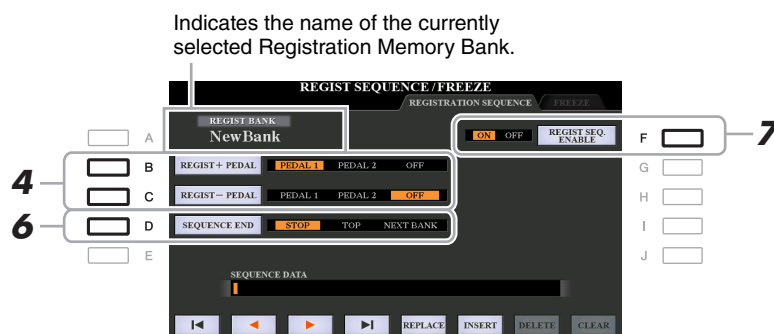

5 Program the Sequence order, from left to right.

Press one of the REGISTRATION MEMORY [1]–[8] buttons on the panel, then press the [6 ▲▼] (INSERT) button to input the number.

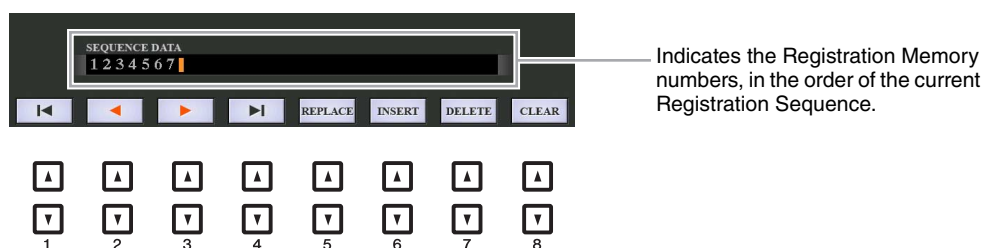

▶ NEXT PAGE

7

Registration Memory

[1 ▲▼]- [4 ▲▼]		Moves the cursor.
[5 ▲▼]	REPLACE	Replaces the number at the cursor position with the currently selected Registration Memory number.
[6 ▲▼]	INSERT	Inserts the number of the currently selected Registration Memory number to the cursor position.
[7 ▲▼]	DELETE	Deletes the number at the cursor position.
[8 ▲▼]	CLEAR	Deletes all numbers in the sequence.

6 Use the [D] (SEQUENCE END) button to determine how Registration Sequence behaves when reaching the end of the sequence.

- **STOP** Pressing the TAB [▶] button or the “advance” pedal has no effect. The sequence is “stopped.”
- **TOP** The sequence starts again at the beginning.
- **NEXT BANK** ... The sequence automatically moves to the beginning of the next Registration Memory Bank in the same folder.

7 Press the [F] (REGIST SEQ. ENABLE) button to turn the Registration Sequence function on.

8 Press the [EXIT] button to exit from the operation display.

After the confirmation message appears, press the [G] (YES) button to store the Registration Sequence program temporarily.

NOTICE

Keep in mind that all Registration Sequence data is lost when changing Registration Memory Banks, unless you’ve saved it with the Registration Memory Bank file. For instructions on saving, see the section below.

Saving the Registration Sequence Settings

The settings for the Sequence order and how Registration Sequence behaves when reaching the end of the sequence (SEQUENCE END) are included as part of the Registration Memory Bank file. To store your newly programmed Registration Sequence, save the current Registration Memory Bank file.

1 Press the REGIST BANK [+] and [-] buttons simultaneously to call up the REGISTRATION BANK Selection display.

2 Press the [6 ▼] button of MENU 2 to save the Bank file.

For details, refer to “Basic Operations” in the Owner’s Manual.

Using the Registration Sequence

- 1** Select the desired Registration Bank.
- 2** At the upper right of the Main display, confirm the Registration Sequence.

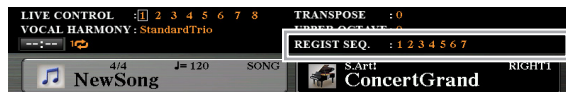

- 3** Press the TAB [◀] or [▶] button, or press the Foot Pedal to select the first Registration Memory number.

The box appears around the left-most number, indicating that this Registration Memory number is currently selected.

- 4** Use the TAB buttons or Foot Pedal during your keyboard performance.

To return to the status in which no Registration Memory number is selected, press the TAB [◀] and [▶] buttons simultaneously while the Main display is called up.

NOTE The pedal can be used for Registration Sequence no matter which display is called up (except for the REGIST SEQUENCE display).

Contents

Making and Saving the Microphone/Guitar Settings (EQ/CMP)	88
• Saving the Microphone/Guitar Settings	89
• MIC/GUITAR Page.....	89
• TALK Page.....	90
Setting and Editing Vocal Harmony Types (PSR-S970)	91
• Setting up the Vocal Harmony Control Parameters	91
• Editing the Vocal Harmony Types	93
Editing the Synth Vocoder Types (PSR-S970)	98
• Editing the OVERVIEW Tab Parameters	99
• Editing the DETAIL Tab Parameters	101

Making and Saving the Microphone/Guitar Settings (EQ/CMP)

This section explains how to make and save the detailed settings for the microphone/guitar.

- 1** Connect a microphone or guitar, press the [MIC SETTING/VOCAL HARMONY] button (PSR-S970) or [MIC SETTING] (PSR-S770) button to call up the operation display, then press the [A] (MIC/GUITAR) button to set it to ON.

This lets you talk into the microphone or play the guitar and hear the changes made while setting the parameters.

- 2** Press the [B] (EQ/CMP) button to call up the EQ/CMP SETTING display.
- 3** Select the desired page, MIC/GUITAR or TALK, by using the TAB [◀][▶] buttons.

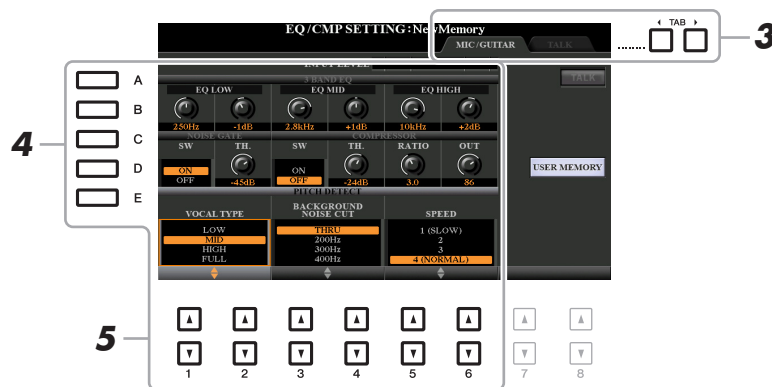

NOTE The settings on the TALK page are the settings that are active when the [F] (TALK) button is on.

- 4** Use the [A]–[E] buttons to select the specific row (or group) of parameters to be adjusted.
- 5** Set the value of specific parameters in the row by using the [1 ▲▼]–[6 ▲▼] buttons.

For information on each parameter, see [pages 89–90](#).

NOTICE

After setting, go to the EQ/CMP SETTING MEMORY display by pressing the [I] (USER MEMORY) button and save the settings (see [page 89](#)). The settings will be lost if you exit from this display or turn off the power to the instrument without carrying out the Save operation.

Saving the Microphone/Guitar Settings

All the settings (MIC/GUITAR and TALK pages) are saved together as a single file. Up to ten files can be saved.

- 1** On the EQ/CMP SETTING display (in step 3 on [page 88](#)), press the [I] (USER MEMORY) button.
- 2** Press the [6 ▼] (SAVE) button to save the file to the USER drive.

For details on the naming and saving procedures, refer to “Basic Operations” in the Owner’s Manual.

NOTE The microphone/guitar setting file can be saved only to internal USER drive. If you want to save this setting on the USB flash drive, save the User Effect file on the display called up via [FUNCTION] → TAB [▶] MENU 2 → [G] SYSTEM → TAB [◀|▶] SETUP FILES → [H] USER EFFECT FILES.

Calling Up the Microphone/Guitar Settings Saved to USER

- 1** Call up the EQ/CMP SETTING MEMORY display.
[MIC SETTING/VOCAL HARMONY] (PSR-S970) or [MIC SETTING] (PSR-S770) button → [B] EQ/CMP SETTING → [I] USER MEMORY
- 2** Press the [A]–[J] buttons to select the desired setting file.

MIC/GUITAR Page

■ 3BAND EQ (selected by [A]/[B] buttons)

EQ (Equalizer) is a processor that divides the frequency spectrum into multiple bands which can be boosted or cut as required to tailor the overall frequency response. This instrument features a high-grade three-band (LOW, MID and HIGH) digital equalizer function for the microphone/guitar sound.

[1 ▲▼]/ [3 ▲▼]/ [5 ▲▼]	Hz	Adjusts the center frequency of the corresponding band.
[2 ▲▼]/ [4 ▲▼]/ [6 ▲▼]	dB	Boosts or cuts the level of the corresponding band by up to 12 dB.

■ NOISE GATE (selected by [C]/[D] buttons)

This effect mutes the input signal when the input from the microphone/guitar falls below a specified level. This effectively cuts off extraneous noise, allowing the desired signal (vocal, etc.) to pass.

[1 ▲▼]	SW (Switch)	Turns the Noise Gate on or off.
[2 ▲▼]	TH. (Threshold)	Adjusts the input level at which the gate begins to open.

■ COMPRESSOR (selected by [C]/[D] buttons)

This effect holds down the output when the input signal from the microphone/guitar exceeds a specified level. This is especially useful for smoothing out vocals that have widely varying dynamics. It effectively “compresses” the signal, making soft parts louder and loud parts softer. For a maximum compression effect, set RATIO to a high setting and adjust the OUT parameter for optimum volume.

[3 ▲▼]	SW (Switch)	Turns the Compressor on or off.
[4 ▲▼]	TH. (Threshold)	Adjusts the input level above which the Compressor is applied.
[5 ▲▼]	RATIO	Adjusts the compression ratio. Higher ratios result in a more compressed sound, with a reduced dynamic range.
[6 ▲▼]	OUT	Adjusts the final output level.

■ (PSR-S970) PITCH DETECT (selected by [E] button)

Determines how this instrument detects or recognizes the pitch of the microphone sound you input during performance.

[1 ▲▼]/ [2 ▲▼]	VOCAL TYPE	Set this to obtain the most natural vocal harmony, depending on your voice. LOW: Setting for lower voices. This setting is also appropriate for growling and shouting. MID: Setting for mid-range voices. HIGH: Setting for higher voices. This setting is also appropriate for singing close to the microphone. FULL: Setting for vocalists having a wide range, from low to high.
[3 ▲▼]/ [4 ▲▼]	BACKGROUND NOISE CUT	THRU, 200Hz, 300Hz, 400Hz, 500Hz This allows you to filter out low noises that would interfere with the Vocal Harmony effect. A setting of “THRU” turns the noise filter off.
[5 ▲▼]/ [6 ▲▼]	SPEED	1 (SLOW) – 4 (NORMAL) – 15 (FAST) Adjusts the response of the Vocal Harmony effect, or how quickly harmonies are generated in response to your voice. NOTE When the Vocal Harmony's Pitch Detect Speed of one or both parts of Lead and Harm. are set to “as Mic Setting” in the DETAIL tab (page 97), this parameter is effective. In other settings, the setting of the Vocal Harmony's Pitch Detect Speed is effective.

TALK Page

The settings here are for your speech or announcements (NOT your singing performance), and are active when the [F] (TALK) button is set to ON. All indications and parameters (with the exception of TALK MIXING below) are the same as in the MIC/GUITAR page. However, the settings are independent from those in the MIC/GUITAR page.



■ TALK MIXING (selected by [E] button)

[1 ▲▼]	VOLUME	Determines the output volume of the microphone sound.
[2 ▲▼]	PAN	Determines the stereo pan position of the microphone sound.
[3 ▲▼]	REVERB DEPTH	Determines the depth of the reverb effects applied to the microphone sound.
[4 ▲▼]	CHORUS DEPTH	Determines the depth of the chorus effects applied to the microphone sound.
[5 ▲▼]/ [6 ▲▼]	REDUCTION LEVEL	Determines the amount of reduction to be applied to the overall sound (excepting the microphone input)—allowing you to effectively adjust the balance between your voice and the overall instrument sound.

Setting and Editing Vocal Harmony Types (PSR-S970)

Setting up the Vocal Harmony Control Parameters

You can set which part controls the Vocal Harmony regardless of the current Vocal Harmony Type.

1 Call up the Vocal Harmony Type Selection display.

[MIC SETTING/VOCAL HARMONY] → [E] (TYPE)



NOTE Check that the microphone is properly connected (Owner's Manual, chapter 8) and the settings (Reference Manual, page 88) are adjusted correctly before setting the Vocal Harmony Control parameters here.

2 Press the [8 ▲] (SET UP) button to call up the Setup display, then set the value by using the [2 ▲▼]–[5 ▲▼] and [7 ▲▼] buttons.

For information on each parameter, see page 92.

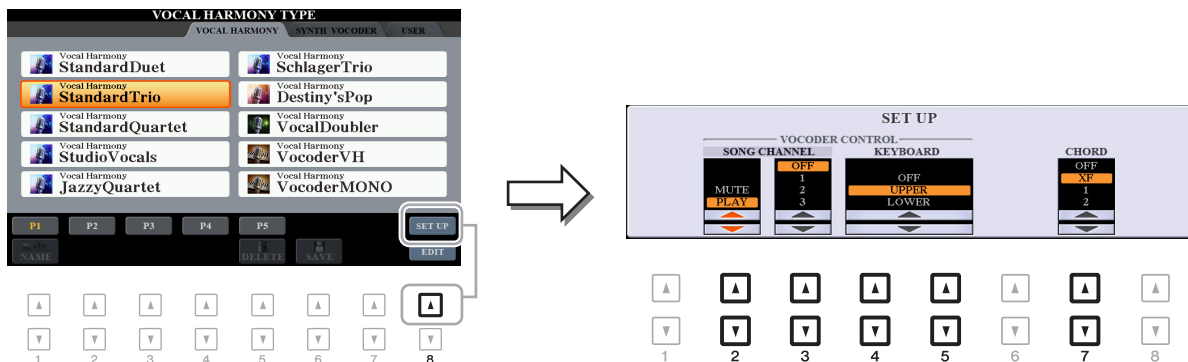

3 After you finish setting the value, press the [EXIT] button to close the Setup display.

NEXT PAGE

■ Setup Parameters

[2 ▲▼]– [5 ▲▼]	VOCODER CONTROL	The Vocal Harmony effect in the Vocoder and Vocoder-Mono modes is controlled by the notes you play on the keyboard and/or Song data.
[2 ▲▼]	SONG CHANNEL MUTE/PLAY	When set to “MUTE,” the channel selected below (to control Harmony) is muted (turned off) during Song playback. This enables you to sing a song with harmony, even without backing or accompaniment.
[3 ▲▼]	SONG CHANNEL OFF/1–16	When set to OFF, Song playback does not affect the Vocal Harmony. When set to one of the values 1–16, note data (played from a Song on this instrument or external MIDI sequencer) contained on the corresponding channel is used to control the harmony.
[4 ▲▼] /[5 ▲▼]	KEYBOARD	<p>OFF: Keyboard performance does not affect the Vocal Harmony.</p> <p>UPPER: Notes played to the right of the Split Point control the harmony.</p> <p>LOWER: Notes played to the left of the Split Point control the harmony.</p> <p>NOTE The separate point of the Keyboard settings (OFF/UPPER/LOWER) is Split Point (LEFT).</p> <p>NOTE When the settings of both keyboard performance and Song data are applied, those settings are merged to control the harmony.</p>
[7 ▲▼]	CHORD	<p>In Chordal mode, the following parameters determine which data in a Song is used for chord detection.</p> <p>OFF: Chords are not detected from the Song data.</p> <p>XF: Chords of XF format are used for the Vocal Harmony.</p> <p>1–16: Chords are detected from note data in the specified Song channel.</p> <p>NOTE The Vocal Harmony may not work properly regardless of the setting here depending on the Song data, since the selected Song may contain no chord data or insufficient note data for chord detection.</p>

Editing the Vocal Harmony Types

This section explains briefly how to create your own Vocal Harmony types, and lists the detailed parameters for editing. A sum total of sixty types can be created and saved.

1 Call up the Vocal Harmony Type Selection display.

[MIC SETTING/VOCAL HARMONY] → [E] TYPE

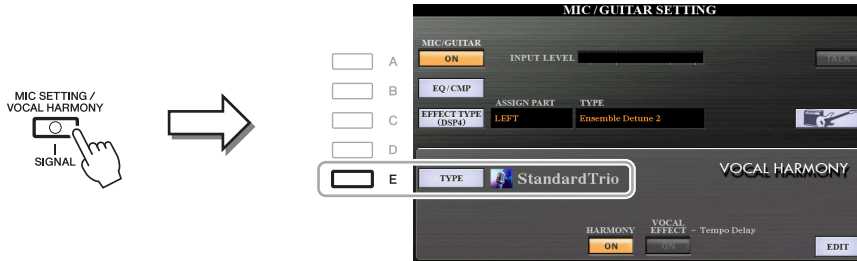

2 Use the TAB [◀][▶] buttons to select the VOCAL HARMONY tab.

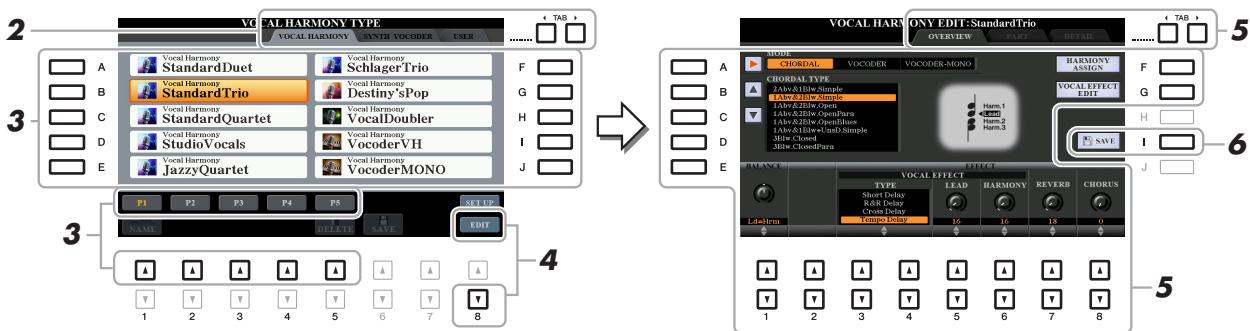

3 Select a Vocal Harmony type to be edited by using the [A]–[J] buttons.

To call up the other display pages for further selections, press one of the [1 ▲]–[5 ▲] buttons.

4 Press the [8 ▼] (EDIT) button to call up the VOCAL HARMONY EDIT display.

NOTE The VOCAL HARMONY EDIT display can also be called up by using the [8 ▲▼] buttons on the MIC/GUITAR SETTING display.

5 Use the TAB [◀][▶] buttons to call up the desired tab, then edit the Vocal Harmony by using [A]–[G] buttons and [1 ▲▼]–[8 ▲▼] buttons.

There are three tabs in the VOCAL HARMONY EDIT display; refer to [pages 94–97](#) for editing each tab.

- **OVERVIEW**Edits basic parameters for Vocal Harmony type, including mode, Chordal Type and Vocal Effect, etc.
- **PART**Adjusts volume and panning, etc. for each of the harmony notes (Harm.1, 2, 3 and Lead).
- **DETAIL**Detailed editing for Vocal Harmony type.

NOTICE

The settings here will be lost if you change to another Vocal Harmony type or you turn the power off without carrying out the Save operation.

6 Press the [I] (SAVE) button to save your edited Vocal Harmony type.

For instructions on the Save operation, refer to “Basic Operations” in the Owner’s Manual.

NOTE The edited Vocal Harmony Type can be saved only to internal USER drive as a file. If you want to save this to the USB flash drive, save the User Effect file on the display called up via [FUNCTION] → TAB [▶] MENU 2 → [G] SYSTEM → TAB [◀] SETUP FILES → [H] USER EFFECT FILES.

■ Editing the OVERVIEW Tab Parameters

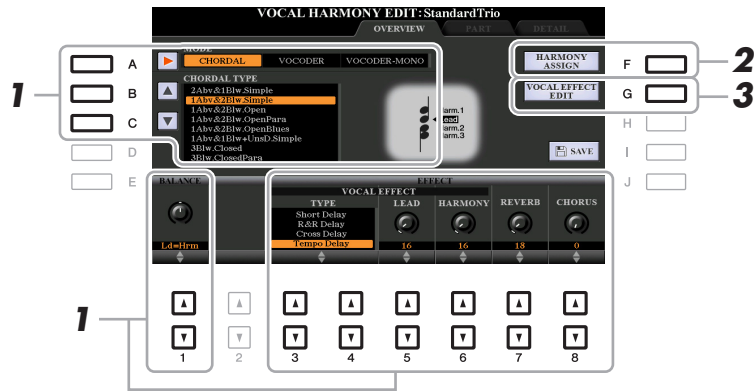

1 Set the value by using the [A]–[C] buttons, [1 ▲▼] and [3 ▲▼]–[8 ▲▼] buttons.

For information on each parameter, see [page 95](#).

2 Press the [F] (HARMONY ASSIGN) button to set how the Vocal Harmony is applied to your singing voice.

For information on each parameter, see [page 95](#).

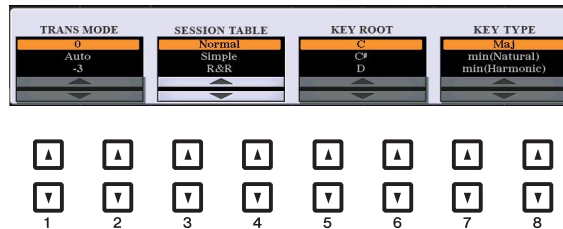

3 Press the [G] (VOCAL EFFECT EDIT) button to edit the Vocal Effect.

On the display called up via this operation, use the [3 ▲▼]–[5 ▲▼] buttons to select the parameter then use the [6 ▲▼]–[7 ▲▼] buttons to set the value. If necessary, you can change the Effect Type from the one selected in step 1 also on this display via the [1 ▲▼]/[2 ▲▼] buttons.

For information on each parameter, refer to the “Vocal Harmony Parameter List” in the Data List on the website.

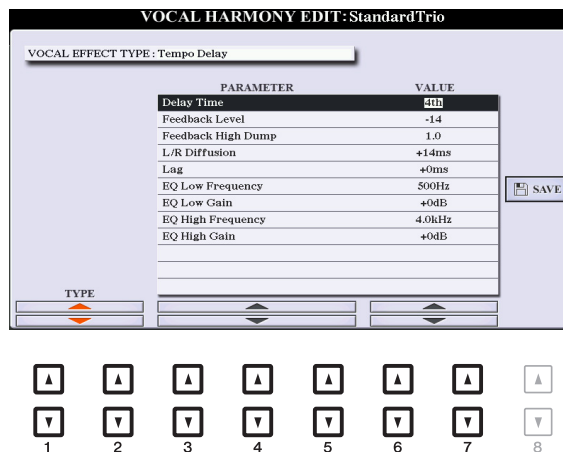

■ OVERVIEW Tab Parameters

[A]	MODE	Determines the mode of the Vocal Harmony effect: Chordal, Vocoder or Vocoder-Mono. Chordal is for conventional vocal harmonies, while Vocoder and Vocoder-Mono are for Vocoder effects. (Vocoder-Mono is for single-note melodies.) When Vocoder or Vocoder-Mono is selected, the Chordal Type parameter below is not available.
[B]/[C]	CHORDAL TYPE	Determines the particular notes and voicings used for generating the vocal harmonies. The harmony and lead notes are also shown as notation in the display. For a list of the Chordal Types, refer to the “Vocal Harmony Parameter List” in the Data List on the website.
[1 ▲▼]	BALANCE	Lets you set the balance between the lead vocal (your own voice) and Vocal Harmony. Raising this value increases the volume of the Vocal Harmony and decreases that of the lead vocal. When this is set to L<H63 (L: Lead Vocal, H: Vocal Harmony), only the Vocal Harmony is output; when it is set to L63>H, only the lead vocal is output.
[3 ▲▼]– [6 ▲▼]	VOCAL EFFECT	Determines the Vocal Effect type and the amount of the effect applied to the lead and harmony vocal sounds.
[3 ▲▼] –[4 ▲▼]	TYPE	Determines the specific Vocal Effect type applied to the lead and harmony vocal sounds. A wide range of reverb, delay, modulation, distortion and other special effects are available. For a list of the effect types, refer to the “Vocal Harmony Parameter List” in the Data List on the website.
[5 ▲▼]	LEAD	Determines the amount of Vocal Effect that is applied to the lead vocal sound.
[6 ▲▼]	HARMONY	Determines the amount of Vocal Effect that is applied to the harmony vocal sound.
[7 ▲▼]	REVERB	Determines the amount of reverb applied to the overall Vocal Harmony sound, both lead and harmony.
[8 ▲▼]	CHORUS	Determines the amount of chorus effect applied to the overall Vocal Harmony sound, both lead and harmony.

■ HARMONY ASSIGN

For detailed information on each parameter, refer to the “Vocal Harmony Parameter List” in the Data List on the website.

[1 ▲▼]/ [2 ▲▼]	TRANS (TRANSPOSE) MODE	Determines the amount by which the harmony parts are transposed. A setting of “0” results in no transposition, while the “Auto” setting results in automatic transposition. When the mode is set to Vocoder or Vocoder-Mono, this parameter is available. Settings: 0, Auto, -3 – +3
[3 ▲▼]/ [4 ▲▼]	SESSION TABLE	Determines how the harmonies will be voiced, or what type of chord will be used in creating the harmonies, according to different musical styles. This parameter is available only when the mode is set to Chordal and the type is set to something other than ScaleDiatonic or Parallel. Settings: Normal, Simple, R&R, UrbanA, UrbanB, Blues7, UrbanC

[5 ▲▼]/ [6 ▲▼]	KEY ROOT	Determines the root key for the transposition. Use this in combination with Key Type below to enable modal scale harmony transposition. When the Chordal Type parameter is set to ScaleDiatonic, this parameter is available. Settings: C, C#, D, D#, E, F, F#, G, G#, A, A#, B
[7 ▲▼]/ [8 ▲▼]	KEY TYPE	Determines the scale type for the transposition. Use this in combination with Key Root above to enable modal scale harmony transposition. When the Chordal Type parameter is set to ScaleDiatonic, this parameter is available. Settings: Maj, min (Natural), min (Harmonic)

■ Editing the PART Tab Parameters

The parameters are arranged in a matrix.

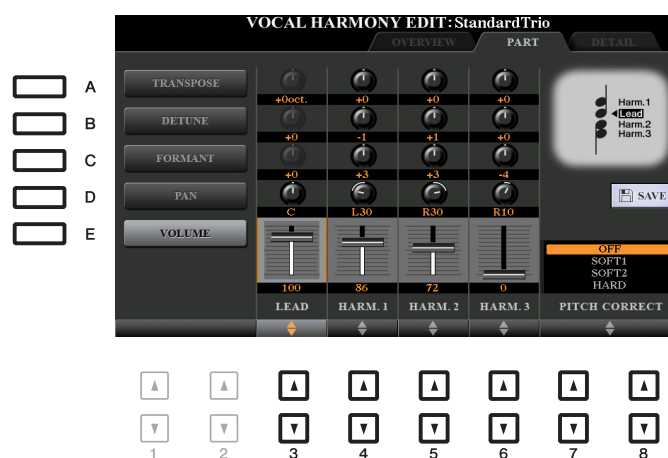

Use the [A]–[E] buttons to select the desired parameter, then edit each of the Vocal Parts including the Harmony notes (Harm.1, 2, 3) and Lead voice (your own voice) via the [3 ▲▼]–[8 ▲▼] buttons.

For information on each parameter, see below.

■ TRANSPOSE (selected by [A] button)

Determines the pitch transposition for each part. The range for all parts is the same; however, the lead vocal sound can only be adjusted in octaves. When the Chordal Type is set to ScaleDiatonic, this parameter changes to Degree. When Pitch Correct is set to OFF, the Lead part is not available. When the Vocoder or Vocoder-Mono mode is selected, the Harmony parts are not available.

TRANSPOSE Settings

Lead: -3 octaves – +3 octaves

Harmony 1, 2, 3: -36 semitones – +36 semitones

DEGREE Settings

Lead: -3 octaves – +3 octaves

Harmony 1, 2, 3: -3 octaves (-22 scale degrees) – Unison – +3 octaves (+22 scale degrees)

■ DETUNE (selected by [B] button)

Determines the fine pitch setting for each part. Adjust this to produce a warm chorusing effect, or to achieve a natural, less-than-perfect vocal sound. When Pitch Correct is set to OFF, the Lead part is not available.

Settings: -50 cents – +50 cents

■ **FORMANT (selected by [C] button)**

Determines the formant setting for each part. This parameter can be used to finely change the character of the vocal sound. The higher the value, the more “feminine” the harmony voice becomes. The lower the value, the more “masculine” the voice. When Pitch Correct is set to Off, the Lead part is not available.

Settings: -62 – +62

■ **PAN (selected by [D] button)**

Determines the pan position setting for each part. Setting each vocal part to a different pan position, with the lead vocal at center, for example, results in a naturally wide stereo sound.

Settings: L63 (Left) – C (Center) – R63 (Right)

■ **VOLUME (selected by [E] button)**

Determines the volume setting for each part. Use this to adjust the relative level balance among the vocal parts.

Settings: 0–127

■ **PITCH CORRECT (set by [7 ▲▼]–[8 ▲▼] buttons)**

Determines how Pitch Correct affects your voice. For information on each parameter, refer to the “Vocal Harmony Parameter List” in the Data List on the website.

Settings: OFF, SOFT1, SOFT2, HARD

■ **Editing the DETAIL Tab Parameters**

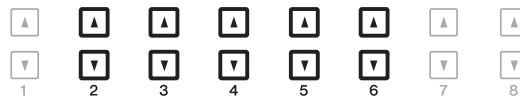
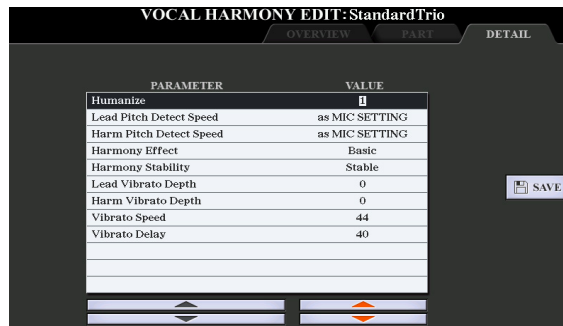

Use the [2 ▲▼]–[4 ▲▼] buttons to select the desired parameter, then set the value of the selected parameter by using the [5 ▲▼]/[6 ▲▼] buttons.

For information on each parameter, refer to the “Vocal Harmony Parameter List” in the Data List on the website.

Editing the Synth Vocoder Types (PSR-S970)

This section explains how to create your own Synth Vocoder types, and lists the detailed parameters for editing. A sum total of sixty types (Synth Vocoder and Vocal Harmony types) can be created and saved.

NOTE For information on “Editing the Vocal Harmony Types,” refer to [page 93](#).

1 Call up the Vocal Harmony Type Selection display.

[MIC SETTING/VOCAL HARMONY] → [E] TYPE



2 Use the TAB [◀][▶] buttons to select the SYNTH VOCODER tab.

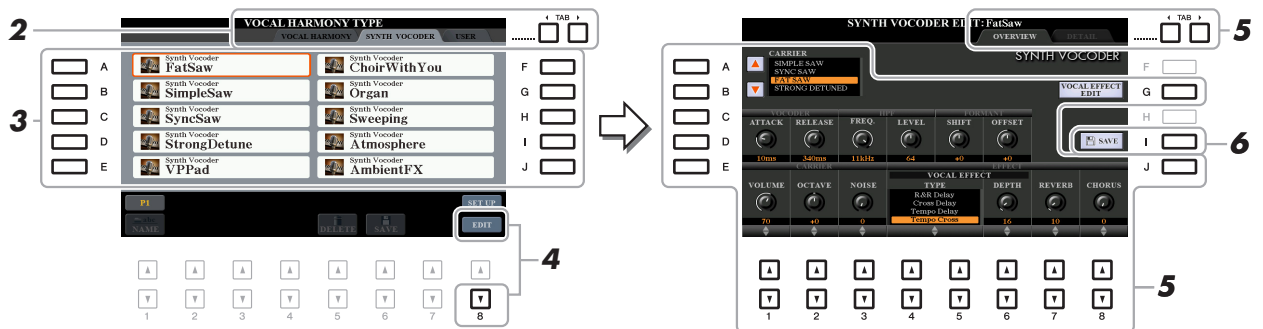

3 Select a Synth Vocoder type to be edited by using the [A]–[J] buttons.

4 Press the [8 ▼] (EDIT) button to call up the SYNTH VOCODER EDIT display.

NOTE The SYNTH VOCODER EDIT display can also be called up by using the [8 ▲▼] buttons on the MIC/GUITAR SETTING display.

5 Use the TAB [◀][▶] buttons to call up the desired tab, then edit the Synth Vocoder by using [A]–[E], [G] and [J] buttons and [1 ▲▼]–[8 ▲▼] buttons.

There are two tabs in the SYNTH VOCODER EDIT display; refer to [pages 99–101](#) for editing each tab.

- **OVERVIEW** Edits basic parameters for Synth Vocoder type, including Carrier, Vocoder Attack/Release and HPF (High Pass Filter), etc.
- **DETAIL** Detailed editing for Synth Vocoder type.

NOTICE

The settings here will be lost if you change to another Synth Vocoder type or you turn the power off without carrying out the save operation.

6 Press the [I] (SAVE) button to save your edited Synth Vocoder type.

For instructions on the Save operation, refer to “Basic Operations” in the Owner’s Manual.

NOTE The edited Vocal Harmony Type can be saved only to internal USER drive as a file. If you want to save this to the USB flash drive, save the User Effect file on the display called up via [FUNCTION] → TAB [▶] MENU 2 → [G] SYSTEM → TAB [◀][▶] SETUP FILES → [H] USER EFFECT FILES.

Editing the OVERVIEW Tab Parameters



- 1 Use the [A]–[E] (or [J]) buttons to select the parameter to be adjusted, then set the value by using the [1 ▲▼]–[8 ▲▼] buttons or sliders.

For information on each parameter, see [pages 100–101](#).

- 2 Press the [G] (VOCAL EFFECT EDIT) button to edit the Vocal Effect.

On the display called up via this operation, use the [3 ▲▼]–[5 ▲▼] buttons to select the parameter then use the [6 ▲▼]–[7 ▲▼] buttons to set the value. If necessary, you can change the Effect Type from the one selected in step 1 also on this display via the [1 ▲▼]/[2 ▲▼] buttons.

For information on each parameter, refer to the Data List on the website.

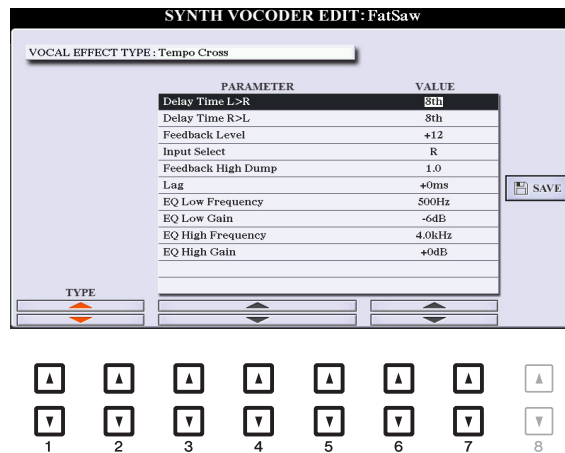

NEXT PAGE

■ **CARRIER (set by [A]/[B] buttons)**

Selects the musical instrument sound used as the source (Carrier) for the Synth Vocoder. (The Carrier serves as the basic sound over which the vocal characteristics are applied.)

■ **VOCODER parameters (selected by [C]/[D] buttons)**

[1 ▲▼]	ATTACK	Determines the attack time of the Synth Vocoder sound. The higher the value, the slower the attack. Settings: 1ms–200ms
[2 ▲▼]	RELEASE	Determines the release time of the Synth Vocoder sound. The higher the value, the slower the decay. Settings: 10ms–3000ms

■ **HPF (High Pass Filter) parameters (selected by [C]/[D] buttons)**

[3 ▲▼]	FREQ. (Frequency)	Determines the HPF cutoff frequency for the microphone input sound. Setting this to a low value results in a minimally processed input sound—in other words, close to the original. Setting this to higher values emphasizes the higher frequency consonant and sibilant sounds (making words easier to understand). Settings: Thru, 500Hz–16kHz
[4 ▲▼]	LEVEL	Determines the level of the microphone sound output from the HPF. Settings: 0–127

■ **FORMANT parameters (selected by [C]/[D] buttons)**

[5 ▲▼]	SHIFT	Determines the amount (in BPF) by which the cutoff frequency value of the BPFs (for the Inst Input) is shifted. This parameter can be used to change the character of the Vocoder sound. Settings: -2, -1, +0, +1, +2
[6 ▲▼]	OFFSET	Adjusts the cutoff frequencies of all BPFs (for the Inst Input) finely. This parameter can be used to finely change the character of the Vocoder sound. Settings: -63 – +0 – +63

■ **CARRIER parameters (selected by [E]/[J] buttons)**

[1 ▲▼]	VOLUME	Determines the level of the Carrier for the Synth Vocoder sound. Settings: 0–127
[2 ▲▼]	OCTAVE	Determines the octave setting of the Carrier for the Synth Vocoder sound. Settings: -2 – +2
[3 ▲▼]	NOISE	Determines the noise level which is input to the Synth Vocoder. This can be used to emphasize sibilant and plosive sounds, and make the speech-like characteristics more pronounced. Settings: 0–127



■ **EFFECT parameters (selected by [E]/[J] buttons)**

[4 ▲▼]/ [5 ▲▼]	TYPE	Determines the specific type of effect applied to the lead Synth Vocoder sound. A wide range of reverb, delay, modulation, distortion and other special effects are available. You can edit the vocal effect by pressing the [G] (VOCAL EFFECT EDIT) button (step 2 on page 99). For a list of the effect types, refer to the Data List on the website.
[6 ▲▼]	DEPTH	Determines the amount of the effect (selected in TYPE above) applied to the overall Synth Vocoder sound.
[7 ▲▼]	REVERB	Determines the amount of reverb applied to the overall Synth Vocoder sound.
[8 ▲▼]	CHORUS	Determines the amount of chorus effect applied to the overall Synth Vocoder sound.

Editing the DETAIL Tab Parameters

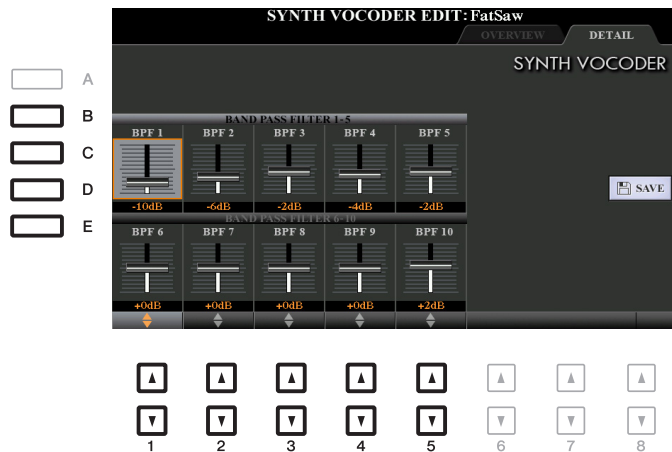

Use the [B]–[E] buttons to select the BAND PASS FILTER 1–5 or 6–10, then set the value by using the [1 ▲▼]–[5 ▲▼] buttons.

NOTE Feedback (howling) may result depending on the setup settings. Be careful especially when you increase values.

■ **BAND PASS FILTER 1–10 parameters**

Determines each output gain of the BPF 1–10 for the Inst Input (keyboard performance sound). The BPF 1 corresponds to the lowest Formant while the BPF 10 corresponds to the highest Formant.

Settings: -18dB – +18dB

Mixing Console

Contents

Editing VOL/VOICE Parameters	102
Editing FILTER Parameters	103
Editing TUNE Parameters	104
Editing EFFECT Parameters	105
• Adjusting the Effect Depth for Each Part	105
• Selecting an Effect Type for each Block	105
• Editing and Saving Your Original Effect Type	107
Editing EQ Parameters	109
• Editing Part EQ Parameters	109
• Editing and Saving Your Original Master EQ (MEQ) Type	110
Editing Master Compressor (CMP) Parameters	111
• Saving Master Compressor Settings	112
Block Diagram	113

Regarding the Mixing Console, the Reference Manual covers detailed descriptions of each parameter while the Owner's Manual covers the basic instructions including the Save operation. You can edit various parameters for the Parts called up via the [MIXER/EQ] button, then save your edits for future recall.

For a visual indication of the signal flow and configuration of the Mixing Console, refer to the Block Diagram on page 113.

Use the TAB [◀]/[▶] buttons to select the various pages that follow.

Editing VOL/VOICE Parameters



[B]/[C]/ [G]/[H]	VOICE	<p>Allows you to re-select the Voices for each part.</p> <p>NOTE Note the following operation limitations.</p> <ul style="list-style-type: none"> • For each Style channel, you can select the Voices for recording on pages 33 and 34. • For each Style or Song channel, you cannot select Voices in the USER drive. • For each Multi Pad, you cannot change the Voice. • When a GM Song is selected, only a Drum Kit Voice can be selected for channel 10 (in the SONG CH9-16 page). <p>NOTE For a Style or Song channel, calling up a rhythm/percussion Voice (Drum Kit, etc.) will replace the channel settings with those for the new Voice. In such a case, the original settings may not be restored even if you re-select the original Voice. To restore the original sound, select the same Style or Song again without carrying out the Save operation.</p>
[D]/[I]	PANPOT	Determines the stereo position of the selected part (channel).
[E]/[J]	VOLUME	Determines the volume of each part or channel, giving you fine control over the balance of all the parts.

Editing FILTER Parameters



[D]/[I]	HARMONIC CONTENT	Allows you to adjust the Resonance (page 17) for each part.
[E]/[J]	BRIGHTNESS	Determines the brightness of the sound for each part by adjusting the Cut-off Frequency (page 17).

Editing TUNE Parameters



[A]/[B]/ [F]/[G]	PORTAMENTO TIME	Portamento is a function that creates a smooth transition in pitch from the first note played on the keyboard to the next. The Portamento Time determines the pitch transition time. Higher values result in a longer pitch change time. Setting this to “0” results in no effect. This parameter is available when the selected keyboard part is set to MONO (page 16).
[C]/[H]	PITCH BEND RANGE	Determines the range of the [PITCH BEND] wheel for each keyboard part. The range is from “0” to “12” with each step corresponding to one semitone.
[D]/[I]	OCTAVE	Determines the range of the pitch change in octaves, over two octaves up or down for each keyboard part. The value set here is added to the setting made via the UPPER OCTAVE [-]/[+] buttons.
[E]/[J]	TUNING	Determines the pitch of each keyboard part in cents. NOTE In musical terms a “cent” is 1/100th of a semitone. (100 cents equal one semitone.)
[1 ▲▼]- [3 ▲▼]	TRANSPOSE	Allows you to set transposition for the overall sound of the instrument (MASTER), Song playback (SONG), or the keyboard pitch (KBD), respectively. Please note that the “KBD” setting also transposes the pitch of Style playback and the Multi Pads (since these are also affected by keyboard play in the left-hand section).

Editing EFFECT Parameters

This instrument features six Effect Blocks, giving you powerful tools to richly enhance the sounds of the instrument or completely transform them. The Effects are divided into the following groups:

■ Reverb, Chorus:

The Effects of these Blocks are applied to the overall sound or all Parts. In each of these Effect Blocks, you can select only one Effect Type at a time and adjust the Send Level (Depth) for each Part as well as the Return Level for all Parts.

■ DSP1:

When the “Connection” parameter is set to “System” in step 2 of [page 108](#), the Effects of this Block are applied only to the Style and Song sounds. In this status, you can select only one Effect Type at a time and adjust the Send Level (Depth) for each Part as well as Return Level for all Parts. When the “Connection” parameter is set to “Insertion,” the Effect of this Block is applied to a specific channel of the Style and Song.

■ DSP2-4:

The Effects of these Blocks are applied to a specific Part or Channel, with the exception of the Multi Pads and microphone/guitar input. Different Effect Types can be selected for each of the available Parts or Channels.

Adjusting the Effect Depth for Each Part



Use the [B]–[E] or [G]–[J] buttons to select the desired Effect Block, then use the [1 ▲▼]–[8 ▲▼] buttons to adjust the Effect Depth for each Part.

Selecting an Effect Type for each Block

This section covers how to change the Effect Type of each Effect Block. The settings here can be saved to a Registration Memory, Song or Style.

- 1 Call up the desired page from PANEL, STYLE or SONG by pressing the [MIXER/EQ] button, repeatedly, if necessary.

➤ NEXT PAGE

2 In the EFFECT page, press the [F] (TYPE) button to call up the Effect Type Selection display.

(PSR-S970)

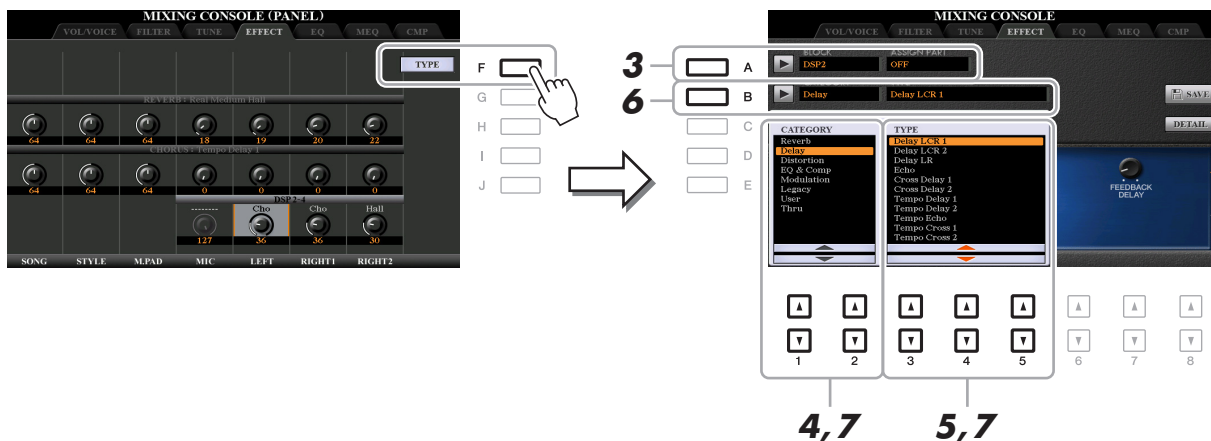

(PSR-S770)

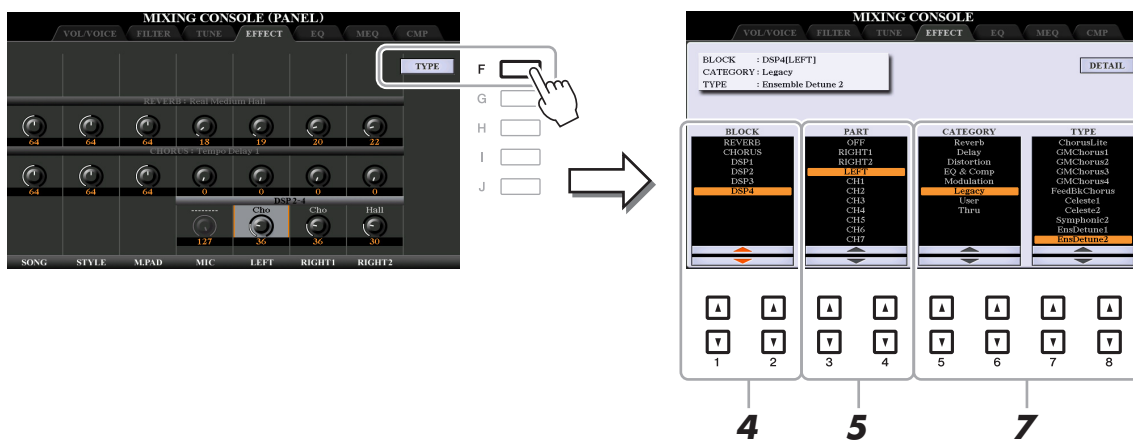

3 (PSR-S970) Press the [A] button.

4 Use the [1 ▲▼]/[2 ▲▼] buttons to select the Effect Block.

Effect Block	Effect-applicable parts	Effect characteristics
REVERB	All parts	Recreates the warm ambience of playing in a concert hall or jazz club.
CHORUS	All parts	Produces a richly textured sound as if several parts are being played simultaneously. In addition, other type effects (such as reverb, delay, etc.) can also be selected in this effect block.
DSP1	Style part, Song channel 1–16	In addition to Reverb and Chorus, a wide variety of Effect Types are provided, such as Distortion and Wah.

NEXT PAGE

Effect Block	Effect-applicable parts	Effect characteristics
DSP2, DSP3, DSP4	RIGHT 1, RIGHT 2, LEFT, Song channel 1–16, MIC/GUITAR*	In addition to Reverb and Chorus, a wide variety of Effect Types are provided, such as Distortion and Wah. For each of DSP2–4, you can select one of the Parts or Channels listed at left. When you select “RIGHT2” for DSP2, for example, the DSP2 Effect is applied only to the Right 2 part. Note that if you select a Song or Style which needs the DSP2–4 Blocks, the Part assignment of these three Blocks will be changed automatically with last priority according to the data. * Available only for DSP4. If you want to apply a certain Effect only to the microphone or guitar sound, select “MIC/GUITAR” for the DSP4.

5 Use the [3 ▲▼]/[4 ▲▼] buttons to select the Part to which you want to apply the effect.

Note that a Part cannot be selected if “REVERB,” “CHORUS,” or “DSP1” (when the “Connection” parameter is set to “System;” see page 108) is selected. This is because only one of the Effect Types can be selected to be commonly applied to all available Parts.

6 (PSR-S970) Press the [B] button.

7 (PSR-S970) Use the [1 ▲▼]/[2 ▲▼] buttons to select the Category, and then use the [3 ▲▼]–[5 ▲▼] buttons to select the Effect Type.

(PSR-S770) Use the [5 ▲▼]/[6 ▲▼] buttons to select the Category, and then use the [7 ▲▼]/[8 ▲▼] buttons to select the Effect Type.

Note that the Reverb Block is not divided into any Categories.

If you want to edit detailed Parameters of the selected Effect Type, press the [H] (PSR-S970) or [F] (PSR-S770) button. For details, refer to the next section.

8 Save the Effect Settings to a Registration Memory, Song or Style.

For instructions, refer to the Owner’s Manual.

Editing and Saving Your Original Effect Type

You can edit detailed parameters of the selected Effect Type, and these settings can be saved as your original Effect Type as well as to a Registration Memory, Style or Song as described in the previous section. This section covers how to save the settings as an original Effect Type.

1 Once you’ve selected an Effect Block and Effect Type in the previous section, press the [H] (PSR-S970) or [F] (PSR-S770) button to call up the display for editing the effect parameters.

(PSR-S970)



(PSR-S770)



2 Use the [3 ▲▼]–[5 ▲▼] buttons to select a parameter then use the [6 ▲▼]/[7 ▲▼] buttons to edit the value.

When Reverb, Chorus, or DSP1 is selected as the Effect Block, you can adjust the Return Level via the [8 ▲▼] (RETURN LEVEL) button. If you want to change the Effect Type, use the [1 ▲▼]/[2 ▲▼] buttons.

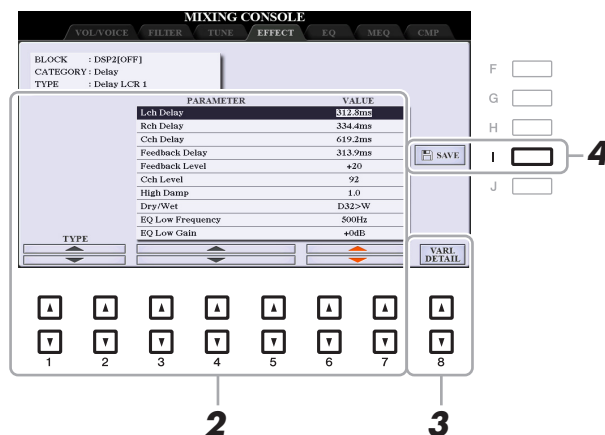

NOTE (PSR-S970) You can also edit the parameter on the display shown in step 1. Use the [D]/[I] or [E]/[J] buttons to select the desired parameter, then use the [1 ▲▼]–[8 ▲▼] buttons to adjust the Effect parameter value.

3 If DSP2, 3 or 4 is selected as the Effect Block, edit the Variation parameter if desired.

Press the [8 ▲▼] (VARI. DETAIL) button to call up the Variation parameter, select a parameter via the [2 ▲▼]–[4 ▲▼] buttons, and then use the [5 ▲▼]/[6 ▲▼] buttons to edit the value. This parameter is effective only when the [DSP VARI.] button lamp lights on the panel. To close this display, press the [EXIT] button.

4 Press the [I] (SAVE) button to call up the display for the Save operation.

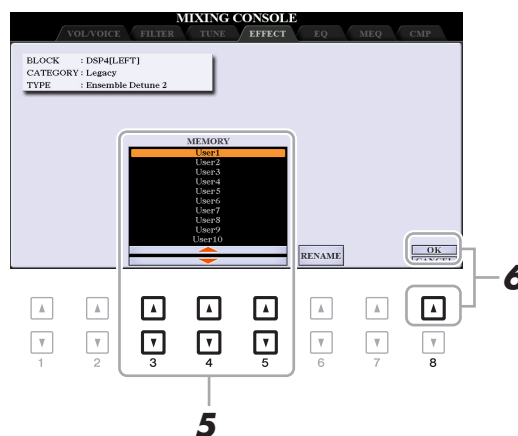

5 Use the [3 ▲▼]–[5 ▲▼] buttons to select the destination for saving the settings as a User Effect.

If necessary, change the User Effect name. Press the [6 ▲▼] (RENAME) button to call up the Character Entry window, enter the name, and then press the [8 ▲] (OK) button.

6 Press the [8 ▲] (OK) button to carry out the Save operation.

7 Press the [EXIT] button to return to the previous display.

The saved User Effect can be selected from the “User” category of the corresponding Effect Block (page 107).

Editing EQ Parameters

Equalizer (also called “EQ”) is a sound processor that divides the frequency spectrum into multiple bands that can be boosted or cut as required to tailor the overall frequency response.

The “EQ” page lets you adjust the EQ for each corresponding part, while the “MEQ” page lets you make overall EQ adjustments for the entire instrument.

Editing Part EQ Parameters



[D]/[I]	EQ HIGH	Boosts or attenuates the high EQ band for each part.
[E]/[J]	EQ LOW	Boosts or attenuates the low EQ band for each part.

Editing and Saving Your Original Master EQ (MEQ) Type

This instrument is equipped with a high-grade eight-band digital EQ. You can select one of the five preset EQ types, or can even create your own custom EQ settings by adjusting the frequency bands, and save the settings to one of two User Master EQ types.

NOTE Master EQ cannot be applied to audio playback or the metronome sound.

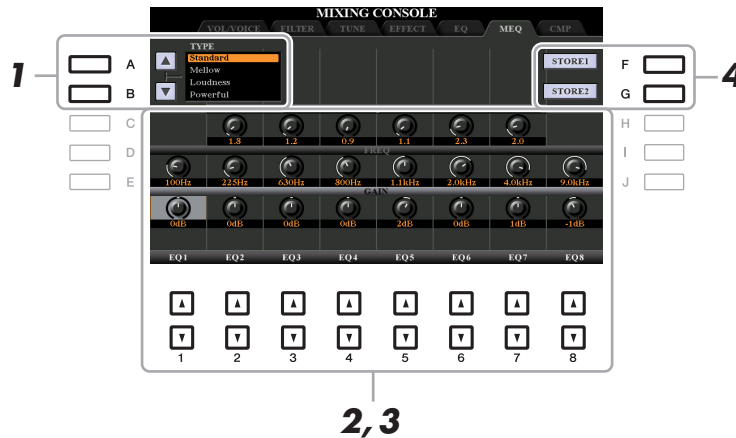

1 Use the [A]/[B] buttons to select the desired EQ type.

Standard: Standard EQ settings in which the instrument's characteristics are optimally brought out.

Mellow: Soft and mellow EQ settings in which high-frequency bands are reduced slightly.

Loudness: Clear EQ settings in which both the low- and high-frequency sounds are emphasized. This is a good match with up-tempo music.

Powerful: Powerful EQ settings in which all frequency sounds are emphasized. This can be used to boost the music for parties, etc.

Flat: Flat EQ settings. The gain of each frequency is set to 0dB.

User1/2: Your own custom EQ settings stored in step 4.

2 Use the [E]/[J] buttons to move the cursor to the GAIN row, then adjust the GAIN level to boost or cut each of the eight bands.

Use the [1 ▲▼]–[8 ▲▼] buttons to adjust the level. Changing the value while the [E] or [J] button is held lets you boost or cut all the eight bands at the same time.

3 If desired, adjust the Q (bandwidth) and the FREQ (center frequency) of each band.

To adjust the bandwidth (also called “Shape” or “Q”), use the [C]/[H] buttons to move the cursor to the Q row, then use the [2 ▲▼]–[7 ▲▼] buttons. The higher the value of Q, the narrower the band width.

To adjust the FREQ (center frequency), use the [D]/[I] buttons to move the cursor to the FREQ row, then use the [1 ▲▼]–[8 ▲▼] buttons. The available FREQ range is different for each band.

4 Press the [F] or [G] (STORE 1 or 2) button to carry out the Store operation.

In the Character Entry window called up via this operation, enter the name, and then press the [8 ▲] (OK) button to actually store your settings as a User Master EQ Type, which can be called up via the [A]/[B] buttons.

Editing Master Compressor (CMP) Parameters

Compressor is an effect commonly used to limit and compress the dynamics (softness/loudness) of an audio signal. For signals that vary widely in dynamics, such as vocals and guitar parts, it “squeezes” the dynamic range, effectively making soft sounds louder and loud sounds softer. When used with gain to boost the overall level, this creates a more powerful, more consistently high-level sound.

This instrument features the Master Compressor applied to the entire sound of this instrument. Although the preset Master Compressor settings are provided, you can create and save your original Master Compressor by adjusting the related parameters.

NOTE Master Compressor cannot be applied to audio playback or the metronome sound.



[G]	ON/OFF	Turns the Master Compressor effect on or off.
[2 ▲▼]/ [3 ▲▼]	TYPE	Selects a Master Compressor type. Standard: Standard Compressor settings. Lite: Light Compressor settings in which the effect is slight. Moderate: Moderate Compressor settings in which the effect is moderately pronounced. Dance Floor: Relatively powerful Compressor settings to emphasize lower pitches. Punchy: Highly exaggerated Compressor settings. User1–5: Your own custom Compressor settings saved in the next section.
[4 ▲▼]	THRESHOLD OFFSET	Determines the threshold (minimum level at which compression starts).
[5 ▲▼]	RATIO OFFSET	Determines the ratio of compression (how much the dynamic range is compressed).
[7 ▲▼]	GAIN OFFSET	Determines the output level.

Saving Master Compressor Settings

The Master Compressor settings you have edited can be saved as a User Compressor type.

- 1** Press the [I] (SAVE) button to enter the USER MASTER COMPRESSOR display.

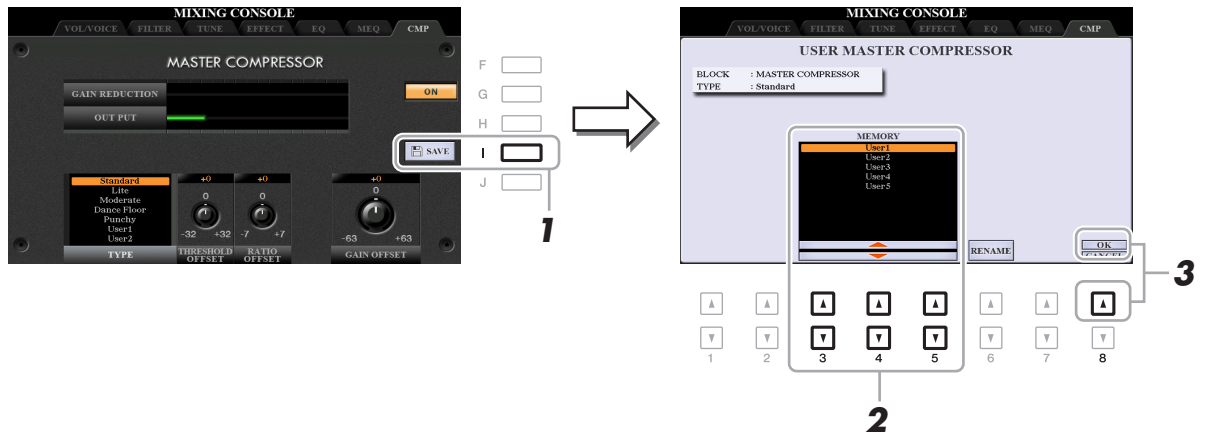

- 2** Select the destination to which the User Master Compressor is to be saved, by using the [3 ▲▼]–[5 ▲▼] buttons.

If necessary, change the User Master Compressor name. Press the [6 ▲▼] (RENAME) button to call up the Character Entry window, enter the name then press the [8 ▲] (OK) button.

- 3** Press the [8 ▲] (OK) button to carry out the Save operation.

- 4** Press the [EXIT] button to return to the previous display.

The saved Master Compressor type is shown in the TYPE selection list.

Block Diagram

PSR-S970

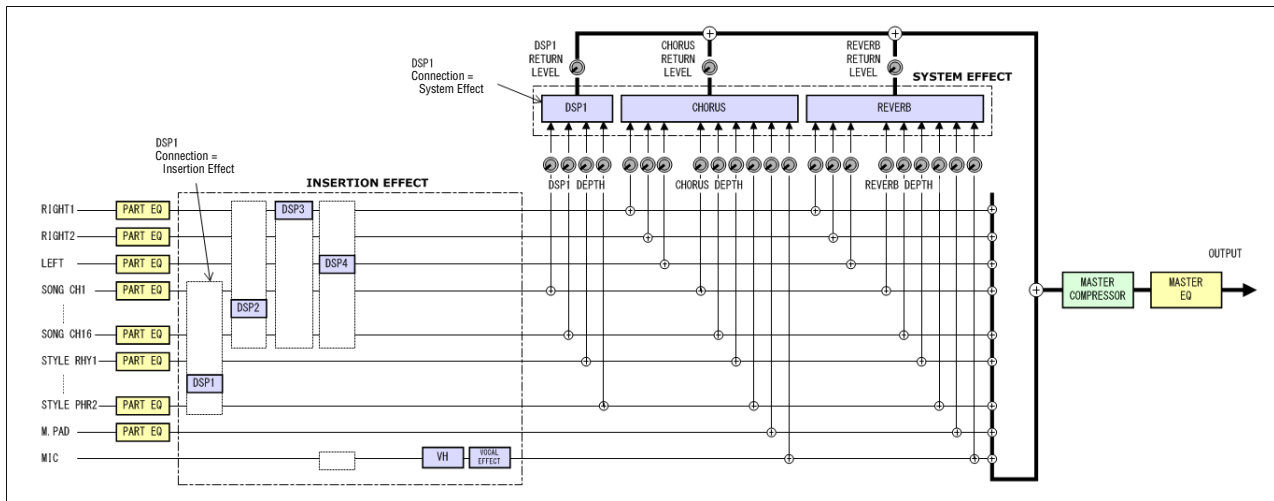

PSR-S770

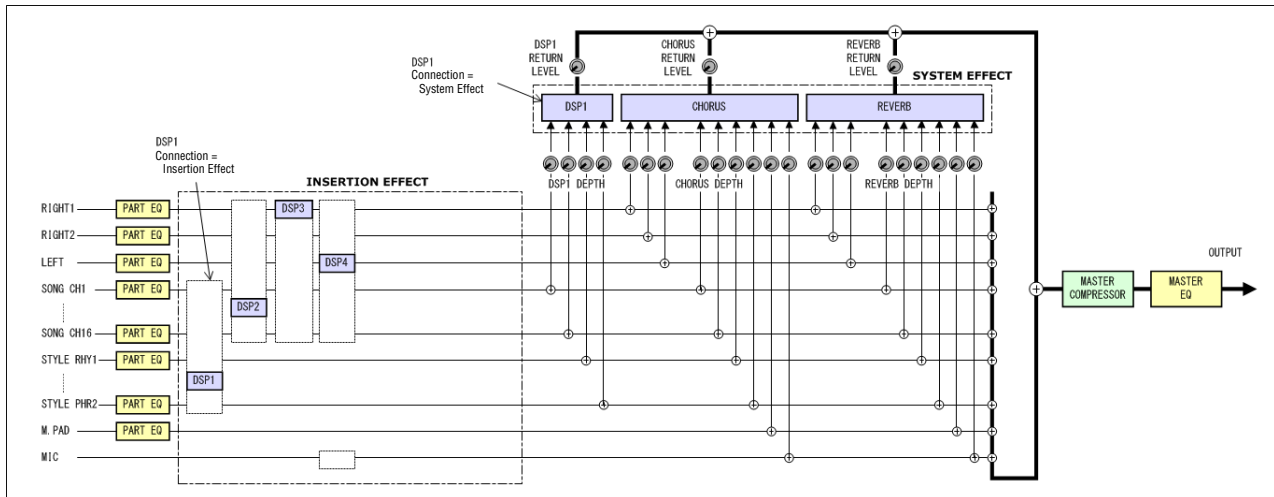

Contents

Footswitch/Foot Controller Settings	114
• Assigning a Specific Function to Each Pedal	114
MIDI Settings	118
• MIDI System Settings	120
• MIDI Transmit Settings	121
• MIDI Receive Settings	122
• Bass Note Settings for Style Playback via MIDI Receive	123
• Chord Type Settings for Style Playback via MIDI Receive	123
Connecting with an iPhone/iPad via Wireless LAN	124
• Infrastructure Mode	124
• Access Point Mode	125

Footswitch/Foot Controller Settings

Assigning a Specific Function to Each Pedal

The functions of the foot pedals connected to the FOOT PEDAL [1]/[2] jacks can be changed individually from the default settings (sustain, etc.)—for example, letting you use the footswitch to start/stop Style playback, or use the foot controller to produce pitch bends.

NOTE For information on how to connect a foot pedal or what kinds of pedals can be connected, refer to the Owner's Manual, chapter 10.

1 Call up the operation display.

[FUNCTION] → TAB [◀] MENU 1 → [D] CONTROLLER → TAB [◀] FOOT PEDAL

2 Use the [A]/[B] buttons to select one of the two foot pedals to which the function is to be assigned.

On the display, the numbers 1 and 2 correspond to the FOOT PEDAL jacks [1] and [2] respectively.

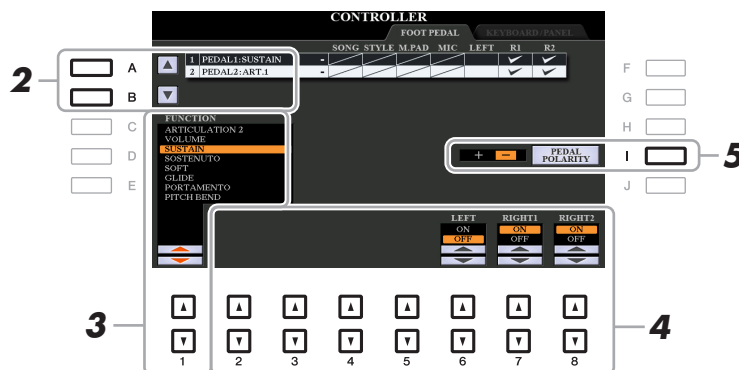

3 Use the [1 ▲▼] buttons to select the function to be assigned to the pedal specified in step 2.

For information on available functions, see [pages 115–117](#).

NOTE You can also assign other functions to the pedal—Punch in/out of Song ([page 66](#)) and Registration Sequence ([page 85](#)). If you assign multiple functions to the pedal, the priority is: Punch in/out of Song → Registration Sequence → Functions assigned here.



NEXT PAGE

4 Use the [2 ▲▼]–[8 ▲▼] buttons to set the details of the selected functions (the part for which the function is applied, etc.).

The available parameters differ depending on the function selected in step 3.

5 If necessary, set the polarity of the pedal by using the [I] button.

Pedal on/off operation may differ depending on the particular pedal you've connected to the instrument. For example, pressing down on one pedal may turn the selected function on, while pressing a different make/brand of pedal may turn the function off. If necessary, use this setting to reverse the operation.

■ Assignable Pedal Functions

For functions indicated with “*”, use only the foot controller; proper operation cannot be done with a footswitch.

ARTICULATION 1/2	When you use a Super Articulation Voice that has an effect assigned to the pedal/footswitch, you can enable the effect by pressing the pedal/footswitch. You can turn this pedal function on or off for each keyboard part on this display.
VOLUME*	Allows you to use a foot controller to control the volume. You can turn this pedal function on or off for each keyboard part on this display.
SUSTAIN	Allows you to use a pedal to control sustain. When you press and hold the pedal, all notes played on the keyboard have a longer sustain. Releasing the pedal immediately stops (damps) any sustained notes. You can turn this pedal function on or off for each keyboard part on this display.
SOSTENUTO	Allows you to use a pedal to control the Sostenuto effect. If you play a note or chord on the keyboard and press the pedal while holding the note(s), the notes will sustain as long as the pedal is held. However, all subsequent notes will not sustain. This makes it possible to sustain a chord, for example, while other notes are played staccato. You can turn this pedal function on or off for each keyboard part on this display. NOTE This function will not affect any of the Organ Flutes and only some of the Super Articulation Voices, even if this has been assigned to the foot pedals.
SOFT	Allows you to use a pedal to control the Soft effect. Pressing this pedal reduces the volume and changes the timbre of the notes you play. This is effective only for certain appropriate Voices. You can turn this pedal function on or off for each keyboard part on this display.
GLIDE	When the pedal is pressed, the pitch changes, and then returns to normal pitch when the pedal is released. You can turn this pedal function on or off for each keyboard part on this display. UP/DOWN: Determines whether the pitch change goes up (is raised) or down (is lowered). RANGE: Determines the range of the pitch change, in semitones. ON SPEED: Determines the speed of the pitch change when the pedal is pressed. OFF SPEED: Determines the speed of the pitch change when the pedal is released.
PORTAMENTO	The portamento effect (a smooth slide between notes) can be produced while the pedal is pressed. Portamento is produced when notes are played legato style (i.e., a note is played while the preceding note is still held). The portamento time can also be adjusted from the Mixing Console display (page 104). You can turn this pedal function on or off for each keyboard part on this display. NOTE This function will not affect any of the Organ Flutes and only some of the Super Articulation Voices, even if this has been assigned to the foot pedals.

PITCH BEND*	Allows you to bend the pitch of notes up or down by using the pedal. You can turn this pedal function on or off for each keyboard part on this display. UP/DOWN: Determines whether the pitch change goes up (is raised) or down (is lowered). RANGE: Determines the range of the pitch change, in semitones.
MODULATION*	Applies modulation effects, such as vibrato, to notes played on the keyboard. You can turn this pedal function on or off for each keyboard part on this display.
MODULATION (ALT)	This is a slight variation on MODULATION above, in which the effects (waveform) can be alternately turned on/off by each press of the pedal/footswitch. You can turn this pedal function on or off for each keyboard part on this display.
DSP VARIATION	Same as the [DSP VARI.] button on the panel. You can turn this pedal function on or off for each keyboard part on this display.
PEDAL CONTROL (WAH)	Applies the wah effect to notes played on the keyboard when the [DSP] button is turned on. You can turn this pedal function on or off for each keyboard part on this display.
HARMONY/ARPEGGIO	Same as the [HARMONY/ARPEGGIO] button.
PEDAL (ARP. HOLD)	While the pedal is pressed, Arpeggio playback continues even after you release the keyboard, and then Arpeggio stops when the pedal is released. Make sure that any one of the Arpeggio type is selected and the [HARMONY/ARPEGGIO] button is turned on.
VOCAL HARMONY (PSR-S970)	Same as the [3 ▲▼]/[4 ▲▼] (HARMONY) buttons in the MIC/GUITAR SETTING display.
VOCAL EFFECT (PSR-S970)	Same as the [5 ▲▼] (VOCAL EFFECT) buttons in the MIC/GUITAR SETTING display.
TALK	Same as the [F] (TALK) button in the MIC/GUITAR SETTING display.
SCORE PAGE +/-	While the Song is stopped, you can turn to the next/previous score page (one page at a time).
LYRICS PAGE +/-	While the Song is stopped, you can turn to the next/previous lyrics page (one page at a time).
TEXT PAGE +/-	You can turn to the next/previous text page (one page at a time).
SONG PLAY/PAUSE	Same as the SONG [▶/■] (PLAY/PAUSE) button.
STYLE START/STOP	Same as the STYLE CONTROL [START/STOP] button.
TAP TEMPO	Same as the [TAP TEMPO] button.
SYNCHRO START	Same as the [SYNC START] button.
SYNCHRO STOP	Same as the [SYNC STOP] button.
INTRO 1–3	Same as the INTRO [I]–[III] buttons.
MAIN A–D	Same as the MAIN VARIATION [A]–[D] buttons.
FILL DOWN	Plays a fill-in, which is automatically followed by the previous Main section (that of the button on the immediate left).

FILL SELF	Plays a fill-in.
FILL BREAK	Plays a break.
FILL UP	Plays a fill-in, followed by the next Main section (that of the button on the immediate right).
ENDING1–3	Same as the ENDING/rit. [I]–[III] buttons.
FADE IN/OUT	Same as the [FADE IN/OUT] button.
FING/ON BASS	The pedal alternately switches between the FINGERED and FINGERED ON BASS modes (page 25).
BASS HOLD	While the pedal is pressed, the Accompaniment Style bass note will be held even if the chord is changed during Style playback. If the fingering is set to “AI FULL KEYBOARD,” the function does not work.
PERCUSSION	The pedal plays a percussion instrument selected by the [4 ▲▼]–[8 ▲▼] buttons. You can use the keyboard to select the desired percussion instrument. NOTE When you select the percussion instrument by pressing a key on the keyboard, the velocity with which you press the key determines the percussion volume.
RIGHT 1 ON/OFF	Same as the PART ON/OFF [RIGHT 1] button.
RIGHT 2 ON/OFF	Same as the PART ON/OFF [RIGHT 2] button.
LEFT ON/OFF	Same as the PART ON/OFF [LEFT] button.
OTS +/-	Calls up the next/previous One Touch Setting.

MIDI Settings

In this section, you can make MIDI-related settings for the instrument. The PSR-S970/S770 gives you a set of ten pre-programmed templates that let you instantly and easily reconfigure the instrument to match your particular MIDI application or external device. Also, you can edit the pre-programmed templates and save up to ten of your original templates to USER memory.

NOTE You can save all your original templates as a single file to internal memory (USER drive) or a USB flash drive: [FUNCTION] → TAB [▶] MENU 2 → [G] SYSTEM → TAB [◀][▶] SETUP FILES → [G] MIDI SETUP FILES. See [page 131](#).

1 Call up the operation display.

[FUNCTION] → TAB [◀] MENU 1 → [I] MIDI

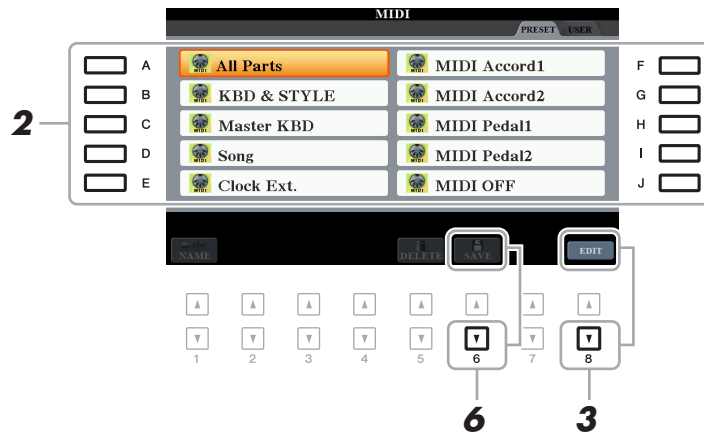

2 Select a pre-programmed template from the PRESET page ([page 119](#)).

If you have already created your original template and saved it to the USER page, you can also select that template from the USER page.

3 To edit the template, press the [8 ▼] (EDIT) button to call up the MIDI display.

4 Use the TAB [◀][▶] buttons to call up the relevant page, then set various parameters to edit the current MIDI template.

- **SYSTEM** MIDI System Settings ([page 120](#))
- **TRANSMIT** MIDI Transmit Settings ([page 121](#))
- **RECEIVE** MIDI Receive Settings ([page 122](#))
- **BASS** Bass Note Settings for Style Playback via MIDI Receive ([page 123](#))
- **CHORD DETECT** Chord Type Settings for Style Playback via MIDI Receive ([page 123](#))

5 When you've finished editing, press the [EXIT] button to return to the MIDI template Selection display.

6 Select the USER tab by pressing the TAB [▶] button, then press the [6 ▼] (SAVE) button to save the edited template.



■ Pre-programmed MIDI Templates

All Parts	Transmits all parts including the keyboard parts (RIGHT 1, 2, and LEFT), with the exception of Song parts.
KBD & STYLE	Basically the same as “All Parts” with the exception of how keyboard parts are managed. The right-hand parts are handled together as “UPPER” instead of RIGHT 1 and 2, and the left-hand part is handled as “LOWER.”
Master KBD	In this setting, the instrument functions as a “master” keyboard, playing and controlling one or more connected tone generators or other devices (such as a computer/sequencer).
Song	All transmit channels are set to correspond to Song channels 1–16. This is used to play Song data with an external tone generator and to record Song data to an external sequencer.
Clock Ext.	Playback or recording (Song, Style, Multi Pad, etc.) synchronizes with an external MIDI clock instead of the instrument’s internal clock. This template should be used when you wish to set the tempo on the MIDI device connected to the instrument.
MIDI Accord 1	MIDI accordions allow you to transmit MIDI data and play connected tone generators from the keyboard and bass/chord buttons of the accordion. This template lets you play melodies from the keyboard and control Style playback on the instrument with the left-hand buttons.
MIDI Accord 2	Basically the same as “MIDI Accord1” above, with the exception that the chord/bass notes you play with your left hand on the MIDI Accordion are recognized also as MIDI note events.
MIDI Pedal 1	MIDI pedal units allow you play connected tone generators with your feet (especially convenient for playing single note bass parts). This template lets you play/control the chord root in Style playback with a MIDI pedal unit.
MIDI Pedal 2	This template lets you play the bass part for Style playback by using a MIDI pedal unit.
MIDI OFF	No MIDI signals are sent or received.

MIDI System Settings

The explanations here apply to the SYSTEM page in step 4 on [page 118](#).

Use the [A]/[B] buttons to select the parameters (below), then set the ON/OFF status, etc. by using the [1 ▲▼]–[8 ▲▼] buttons.

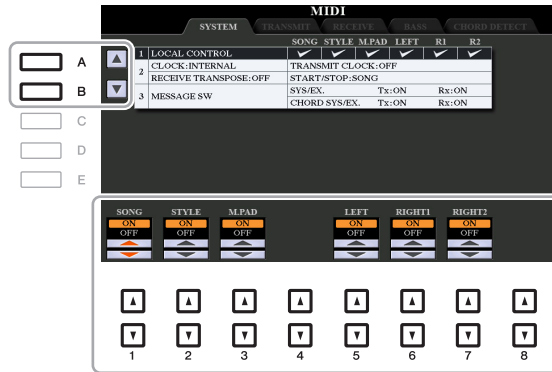

1 Local Control

Turns the Local Control for each part on or off. When Local Control is set to “ON,” the keyboard of the instrument controls its own (local) internal tone generator, allowing the internal Voices to be played directly from the keyboard. If you set Local to “OFF,” the keyboard and controllers are internally disconnected from the instrument’s tone generator section so that no sound is output when you play the keyboard or use the controllers. For example, this allows you to use an external MIDI sequencer to play the instrument’s internal Voices, and use the instrument keyboard to record notes to the external sequencer and/or play an external tone generator.

2 Clock setting, etc.

■ CLOCK

Determines whether the instrument is controlled by its own internal clock or a MIDI clock signal received from an external device. INTERNAL is the normal Clock setting when the instrument is being used alone or as a master keyboard to control external devices. If you are using the instrument with an external sequencer, MIDI computer, or other MIDI device, and you want to synchronize it to that device, set this parameter to the appropriate setting: MIDI, USB 1, or USB 2. In this case, make sure that the external device is connected properly (e.g., to the instrument’s MIDI IN terminal), and that it is properly transmitting a MIDI clock signal.

NOTE When CLOCK is set to a value other than INTERNAL, the tempo is indicated as “Ext.” on the Main display. This means that playback of this instrument is controlled only from an external MIDI device or computer. In this condition, Styles, Songs, Multi Pads or the Metronome cannot be played back even if you carry out the start operation.

NOTE When a USB wireless LAN adaptor is connected to the [USB TO DEVICE] terminal, the “WIRELESS LAN” parameter can also be selected.

■ TRANSMIT CLOCK

Turns MIDI clock (F8) transmission on or off. When set to OFF, no MIDI clock or Start/Stop data is transmitted even if a Song or Style is played back.

■ RECEIVE TRANSPOSE

Determines whether or not the instrument’s transpose setting is applied to the note events received by the instrument via MIDI.

■ START/STOP

Determines whether incoming FA (start) and FC (stop) messages affect Song or Style playback.

3 MESSAGE SW (Message Switch)

■ SYS/EX.

The “Tx” setting turns MIDI transmission of MIDI System Exclusive messages on or off. The “Rx” setting turns MIDI reception and recognition of MIDI System Exclusive messages generated by external equipment on or off.



■ CHORD SYS/EX.

The “Tx” setting turns MIDI transmission of MIDI chord exclusive data (chord detect. root and type) on or off. The “Rx” setting turns MIDI reception and recognition of MIDI chord exclusive data generated by external equipment on or off.

MIDI Transmit Settings

The explanations here apply to the TRANSMIT page in step 4 on [page 118](#). This determines which parts will be sent as MIDI data and over which MIDI channel the data will be sent.

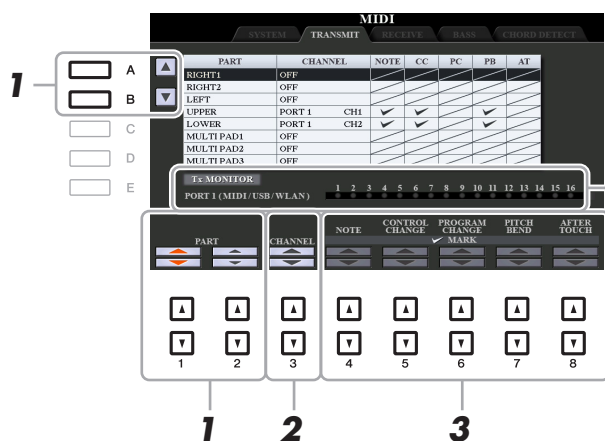

The dots corresponding to each channel (1–16) flash briefly whenever any data is transmitted on the channel(s).

NOTE If “WLAN” is shown, this instrument can handle MIDI messages received via the USB wireless LAN adaptor connected to the [USB TO DEVICE] terminal. When “WLAN” is not shown although the USB wireless LAN adaptor is connected, turn the instrument off then on again.

1 Use the [A]/[B] buttons or [1 ▲▼]/[2 ▲▼] buttons to select the part for changing transmit settings.

The Parts listed on this display are the same as those shown in the MIXING CONSOLE display and CHANNEL ON/OFF display with the exception of the two parts below.

UPPER: A keyboard part played on the right side of the keyboard from the Split Point for the Voices (RIGHT 1 and/or 2).

LOWER: A keyboard part played on the left side of the keyboard from the Split Point for the Voices. This is not affected by the on/off status of the [ACMP] button.

2 Use the [3 ▲▼] buttons to select a channel via which the selected part will be transmitted.

NOTE If the same transmit channel is assigned to several different parts, the transmitted MIDI messages are merged to a single channel—resulting in unexpected sounds and possible glitches in the connected MIDI device.

NOTE Protected Songs cannot be transmitted even if the proper Song channels 1–16 are set to be transmitted.

3 Use the [4 ▲▼]–[8 ▲▼] button to determine the types of data to be sent.

For information on the MIDI messages which can be set here, see “Note Events” on [page 73](#).

MIDI Receive Settings

The explanations here apply to the RECEIVE page in step 4 on [page 118](#). This determines which parts will receive MIDI data and over which MIDI channels the data will be received.

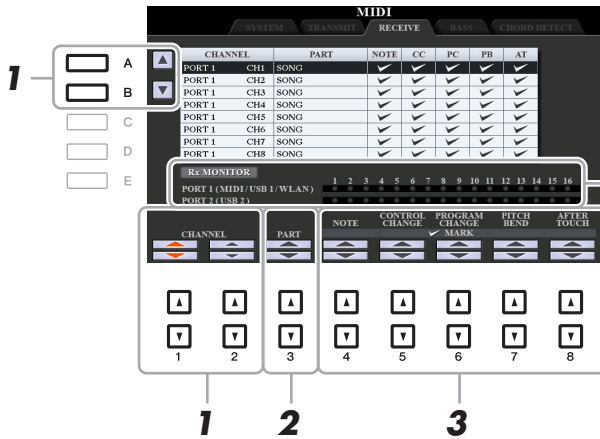

The dots corresponding to each channel (1–16) flash briefly whenever any data is received on the channel(s).

NOTE If “WLAN” is shown, this instrument can handle MIDI messages received via the USB wireless LAN adaptor connected to the [USB TO DEVICE] terminal. When “WLAN” is not shown although the USB wireless LAN adaptor is connected, turn the instrument off then on again.

1 Use the [A]/[B] buttons or [1 ▲▼]/[2 ▲▼] buttons to select the channel to be received.

The instrument can receive MIDI messages over 32 channels (16 channels x 2 ports) by USB connection.

2 Use the [3 ▲▼] buttons to select the part via which the selected channel will be received.

The Parts listed on this display are the same as those shown in the MIXING CONSOLE display and CHANNEL ON/OFF display with the exception of the following parts.

KEYBOARD: The received note messages control the instrument’s keyboard performance.

EXTRA PART 1–5: There are five parts specially reserved for receiving and playing MIDI data.

Normally, these parts are not used by the instrument itself. The instrument can be used as a 32-channel multi-timbral tone generator by using these five parts in addition to the parts (except for the microphone/guitar sound).

3 Use the [4 ▲▼]–[8 ▲▼] button to determine the types of data to be received.

For information on the MIDI messages which can be set here, see “Note Events” on [page 73](#).

MIDI transmission/reception via the USB terminals and MIDI terminals

The relationship between the MIDI terminals and the USB terminals which can be used for transmitting/receiving 32 channels (16 channels x 2 ports) of the MIDI messages is as follows:

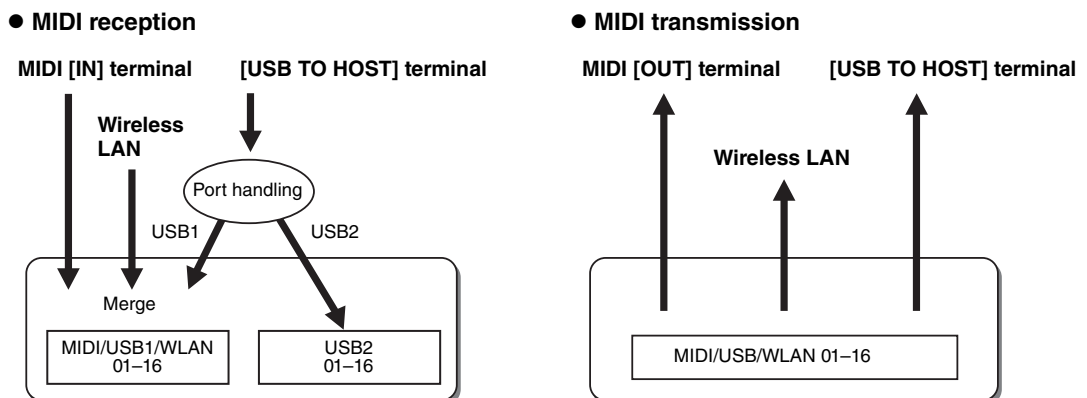

Bass Note Settings for Style Playback via MIDI Receive

The explanations here apply to the BASS page in step 4 on [page 118](#). These settings let you determine the bass note for Style playback, based on the note messages received via MIDI. The note on/off messages received at the channel(s) set to “ON” are recognized as the bass note of the chord of Style playback. The bass note will be detected regardless of the [ACMP] or split point settings. When several channels are simultaneously set to “ON,” the bass note is detected from merged MIDI data received over the channels.

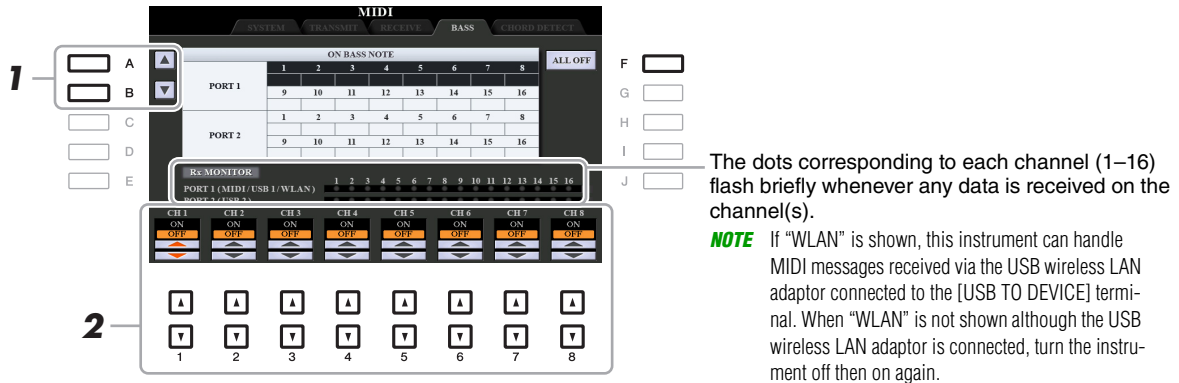

1 Use the [A]/[B] buttons to select the channel.

2 Use the [1 ▲▼]–[8 ▲▼] button to set the desired channel to ON or OFF.

You can also set all channels to OFF by pressing the [F] (ALL OFF) button.

Chord Type Settings for Style Playback via MIDI Receive

The explanations here apply to the CHORD DETECT page in step 4 on [page 118](#). This page lets you select the MIDI channels over which the MIDI data from the external device will be used to detect the Chord Type for Style playback. The note on/off messages received at the channel(s) set to “ON” are recognized as the notes for detecting chords in Style playback. The chords to be detected depend on the fingering type. The chord types will be detected regardless of the [ACMP] or split point settings. When several channels are simultaneously set to “ON,” the chord type is detected from merged MIDI data received over the channels.

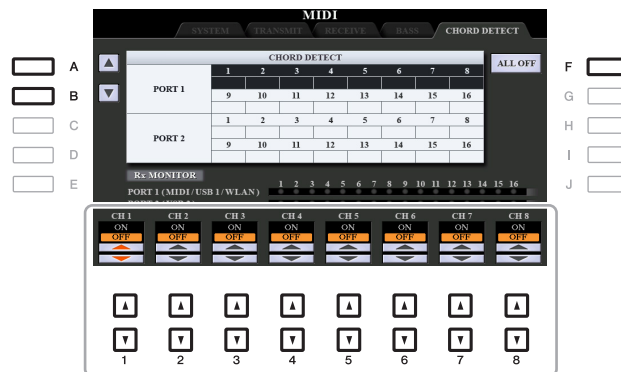

The operation procedure is basically the same as that of the BASS display above.

Connecting with an iPhone/iPad via Wireless LAN

By using a USB wireless LAN adaptor (sold separately), you can connect the PSR-S970/S770 with an iPhone/iPad via a wireless network. For general operating instructions, refer to the “iPhone/iPad Connection Manual” on the website. This section covers only operations that are specific to the PSR-S970/S770. Before starting operations, make sure that the USB wireless LAN adaptor is connected to the [USB TO DEVICE] terminal and call up the setup display via [FUNCTION] → TAB [▶] MENU 2 → [H] WIRELESS LAN.

NOTE If the USB wireless LAN adaptor is not recognized by the instrument, “WIRELESS LAN” for the [H] button is not shown. When “WIRELESS LAN” is not shown even though a USB wireless LAN adaptor has been connected, turn the instrument off then on again.

Infrastructure Mode

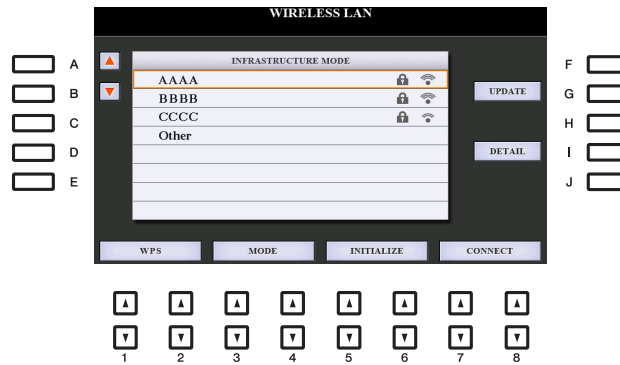

[A]/[B]		Selects the network.
[G]	UPDATE	Updates the network list on the display.
[I]	DETAIL	For setting the detailed parameters on the pages below. After making these settings, press one of the [7 ▲▼]/[8 ▲▼] (SAVE) button to actually save them. IP ADDRESS: Sets the IP address and other related parameters. OTHERS: When the instrument is connected to the network with the Infrastructure Mode, the current time is shown on the Main display. You can set the Time Zone via the [B] button and Daylight Saving Time via the [C] button for your local time. If you want to enter the host name, press the [A] button.
[1 ▲▼]/ [2 ▲▼]	WPS	Connects this instrument to the network via WPS. Press this button followed by the [G] (YES) button, then press the WPS button on your access point within two minutes.
[3 ▲▼]/ [4 ▲▼]	MODE	Switches to the Access Point Mode.
[5 ▲▼]/ [6 ▲▼]	INITIALIZE	Initializes the connection setup to the default factory status.
[7 ▲▼]/ [8 ▲▼]	CONNECT	Connects to the selected network. If you select “Other” by using the [A]/[B] buttons, this calls up the Manual Setup display in which you set the SSID, security method, and password. After entering those, press one of the [7 ▲▼]/[8 ▲▼] buttons in the Manual Setup display to connect to the network.

Access Point Mode

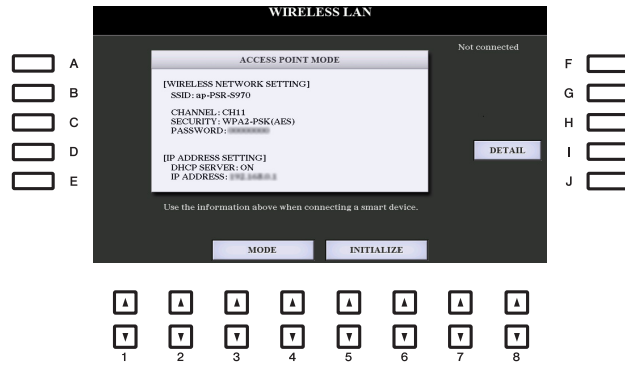

[I]	DETAIL	<p>For setting the detailed parameters on the pages below. After making these settings, press one of the [7 ▲▼]/[8 ▲▼] (SAVE) button to actually save them.</p> <p>WIRELESS NETWORK: For setting the SSID, security, password, and channel.</p> <p>IP ADDRESS: For setting the IP address and other related parameters.</p> <p>OTHERS: For entering the Host name or showing MAC address, etc.</p>
[3 ▲▼]/ [4 ▲▼]	MODE	Switches to the Infrastructure Mode.
[5 ▲▼]/ [6 ▲▼]	INITIALIZE	Initializes the connection setup to the default factory status.

Other Functions

Contents

UTILITY	126
• CONFIG 1	126
• CONFIG 2	127
• PARAMETER LOCK	129
• USB	129
SYSTEM	130
• OWNER	130
• BACKUP/RESTORE	130
• SETUP FILES	131
• RESET	132

This section covers only the UTILITY and SYSTEM displays in the FUNCTION menu. For other displays, refer to the “Function List” in the Owner’s Manual to see where you can find the instructions.

UTILITY

CONFIG 1

Use the [A]/[B] buttons to select the desired parameter.

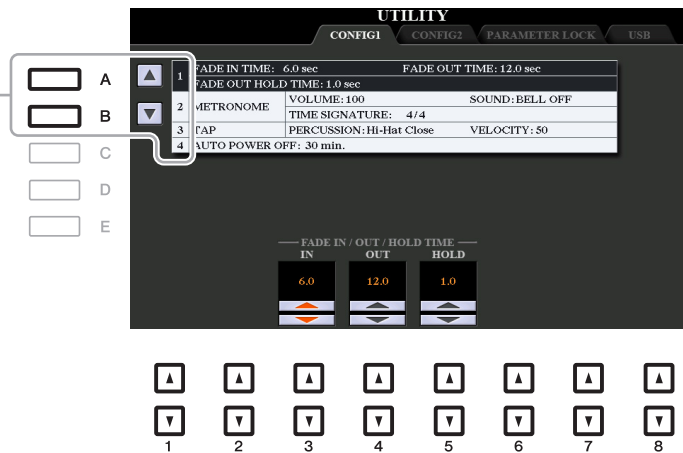

1 Fade In/Out

These parameters determine how Style or Song playback is faded in/out when using the [FADE IN/OUT] button.

[3 ▲▼]	FADE IN TIME	Determines the time it takes for the volume to fade in, or go from minimum to maximum (range of 0–20.0 seconds).
[4 ▲▼]	FADE OUT TIME	Determines the time it takes for the volume to fade out, or go from maximum to minimum (range of 0–20.0 seconds).
[5 ▲▼]	FADE OUT HOLD TIME	Determines the time the volume is held at 0 following the fade out (range of 0–5.0 seconds).



2 Metronome

[2 ▲▼]	VOLUME	Determines the volume of the metronome sound.
[3 ▲▼]– [5 ▲▼]	SOUND	Determines whether a bell accent is sounded or not at the first beat of each measure.
[6 ▲▼]/ [7 ▲▼]	TIME SIGNA- TURE	Determines the time signature of the metronome sound.

3 Tap

This allows you to set the percussion sound and the velocity which sounds when the [TAP TEMPO] button is tapped.

[2 ▲▼]– [4 ▲▼]	PERCUSSION	Selects the percussion sound.
[5 ▲▼]/ [6 ▲▼]	VELOCITY	Sets the velocity.

4 Auto Power Off

For details, refer to “Setting Up” in the Owner’s Manual.

CONFIG 2

Use the [A]/[B] buttons to select the desired parameter.

1 Speaker / Display Content

(PSR-S970) [3 ▲▼]/ [4 ▲▼]	SPEAKER	Determines whether or not the sound is output from the speaker of this instrument. HEADPHONE SW: Speaker sounds normally, but is cut off when headphones are connected to the [PHONES] jack. ON: Speaker sound is always on, even if headphones are connected. OFF: Speaker sound is off. You can only hear the instrument sound via the headphones or an external device connected to the AUX OUT jacks.
(PSR-S770) [4 ▲▼]/ [5 ▲▼]		
[5 ▲▼]/ [6 ▲▼]	DISPLAY OUT (PSR-S970)	Selects display contents for the external monitor. For details, refer to the Owner’s Manual, chapter 10.

2 Display-related settings / Voice Category Button Options

[1 ▲▼]	STYLE TEMPO	Determines whether the default tempo of each preset Style is shown or hidden above the Style name in the Style Selection display.
[2 ▲▼]	VOICE NUMBER	Determines whether the Voice bank and number are shown or hidden in the Voice Selection display. Displaying these is helpful when you want to check which bank select MSB/LSB values and program change number you need to specify when selecting the Voice from an external MIDI device. NOTE The numbers displayed here start from "1." Accordingly the actual MIDI program change numbers are one lower, since that number system starts from "0." NOTE For the GS Voices, the program change numbers are not available even when this parameter is set to ON.
[3 ▲▼]	TIME STAMP	Determines whether the updated date and time are shown or hidden on the File Selection display. When you connect the instrument to the network with the Infrastructure Mode (page 124) by using the USB wireless adaptor (UD-WL01), the instrument gets the "clock" information and the current timestamp (date and time) is recorded to the files you save to the instrument. Once you turn the power off, the clock is set to the factory default and will not be updated unless the instrument is connected to the network.
[5 ▲▼]/ [6 ▲▼]	VOICE CATEGORY BUTTON OPTIONS	Determines how the Voice Selection display is opened when one of the VOICE buttons is pressed. OPEN & SELECT: Opens the Voice Selection display with the previously selected Voice in the Voice category automatically selected (when one of the VOICE buttons is pressed). OPEN ONLY: Opens the Voice Selection display with the currently selected Voice (when one of the VOICE buttons is pressed).
[7 ▲▼]/ [8 ▲▼]	POPUP DISPLAY TIME	Determines the time in which the pop-up displays close. (Pop-up displays are shown when you press buttons such as TEMPO, TRANSPOSE or UPPER OCTAVE, etc.)

3 Arpeggio settings

[3 ▲▼]/ [4 ▲▼]	QUANTIZE	Determines the timing of the Arpeggio Quantize function. Arpeggio playback is synchronized with Song or Style playback, and any slight imperfections are corrected in this timing.
[5 ▲▼]/ [6 ▲▼]	HOLD ON/OFF	Turns on or off the Arpeggio Hold function. When this is set to ON, turning the [HARMONY/ARPEGGIO] button on makes Arpeggio playback continue even after the note has been released. To stop playback, press the [HARMONY/ARPEGGIO] button again.

PARAMETER LOCK

This lets you lock or maintain the settings of specific parameters (such as Effect and Split Point), even when the panel setups are changed by Registration Memory, One Touch Setting, etc.

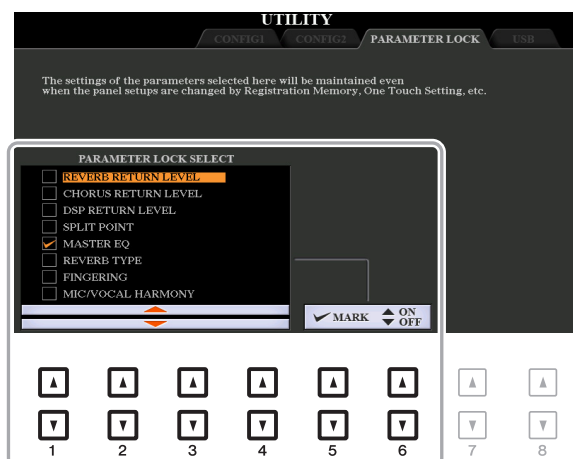

To set this function, use the [1 ▲▼]–[4 ▲▼] buttons to select the desired parameter then use the [5 ▲▼]/[6 ▲▼] buttons to enter or remove the checkmarks. Repeat this step as desired. Items having checkmarks will be locked.

USB

You can set or carry out important USB flash drive-related operations for the instrument. Before using a USB flash drive, be sure to read “Connecting USB Devices” in the Owner’s Manual, chapter 10.

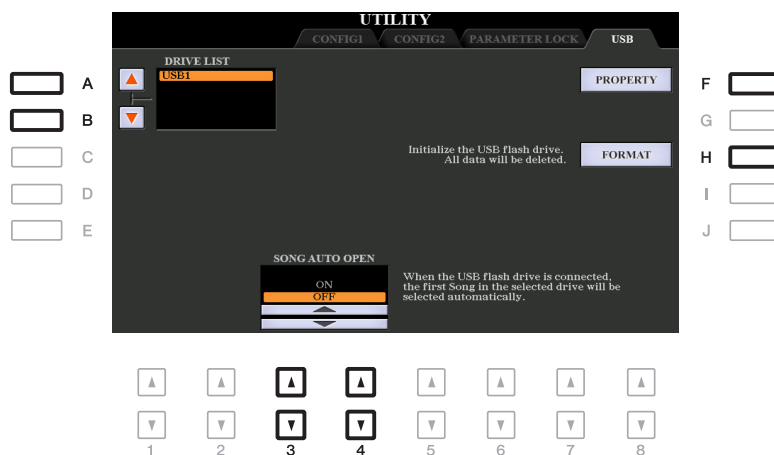

[A]/[B]	DRIVE LIST	Selects the desired drive to be formatted or to be checked for remaining memory.
[F]	PROPERTY	Opens the Property display of the device selected above by the [A]/[B] buttons. You can check the amount of remaining memory on the device. NOTE The displayed remaining memory value is an approximate value.
[H]	FORMAT	Formats the drive selected above by the [A]/[B] buttons. For instructions, refer to the Owner’s Manual, chapter 10.
[3 ▲▼]/ [4 ▲▼]	SONG AUTO OPEN	Turns the Song Auto Open function on or off. When this is set to “ON,” simply connecting the USB flash drive (selected in the Device List above) calls up the first Song in the USB flash drive.

SYSTEM

OWNER

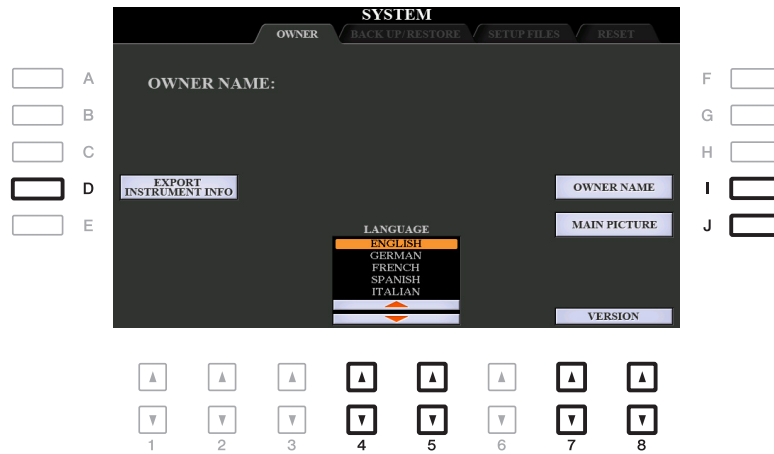

[D]	EXPORT INSTRUMENT INFO	For exporting identification information of the instrument, which may be necessary for using the “Yamaha Expansion Manager” software, to the root directory of the USB flash drive (page 22).
[I]	OWNER NAME	Lets you enter your name as the owner. The Owner name is indicated on the opening display when you turn the power on. For instructions on entering characters, refer to “Basic Operations” in the Owner’s Manual.
[J]	MAIN PICTURE	Lets you select a background picture for the Main display. You can select a picture from among various pictures provided on the PRESET page. After selecting, press the [EXIT] button to close the Selection display. If you want to use an original picture, prepare the desired file (a bitmap “.BMP” file no greater than 800 x 480 pixels) in the USB flash drive, copy it from the USB flash drive to the USER page, then select it from the USER page. Due to access speed limitations, it is not recommended to select the desired file from the USB flash drive. NOTE The explanation about picture compatibility above applies also to the background of the Song Lyric display (page 52).
[4 ▲▼]/ [5 ▲▼]	LANGUAGE	Determines the language used for the display messages. Once you change this setting, all messages will be shown in the selected language.
[7 ▲▼]/ [8 ▲▼]	VERSION	Displays the program version and the hardware ID of this instrument.

BACKUP/RESTORE

Refer to “Basic Operations” in the Owner’s Manual.

SETUP FILES

For the items below, you can save your original settings to USER or USB drive as a single file for future recall.

- 1** Make all desired settings on the instrument.
- 2** Call up the operation display.

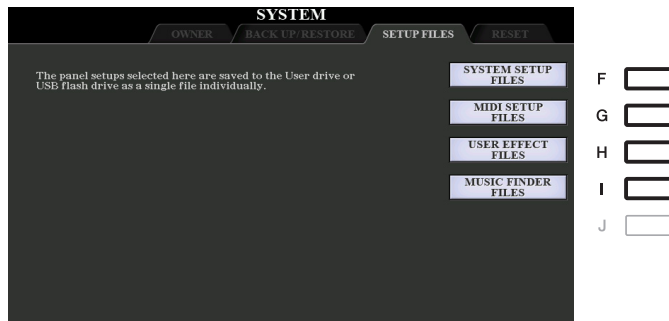

- 3** Use the [F]–[I] buttons to call up the relevant display for saving your data.

[F]	SYSTEM SETUP FILES	Parameters set on the various displays such as the [FUNCTION] → TAB [◀] MENU 1 → [J] UTILITY and MIC/GUITAR SETTING display are handled as a single System Setup file. Refer to the “Parameter Chart” in the Data List on the website for details on which parameters belong to System Setup.
[G]	MIDI SETUP FILES	The MIDI settings including the MIDI Setups on the USER tab display are handled as a single file.
[H]	USER EFFECT FILES	The following data can be managed as a single file. <ul style="list-style-type: none"> • User Effect types page 107 • User Master EQ types page 110 • User Master Compressor types page 112 • User Microphone/Guitar settings page 89 • User Vocal Harmony/Synth Vocoder types (PSR-S970 only) .. pages 93, 98
[I]	MUSIC FINDER FILES	All the preset and created Records of the Music Finder are handled as a single file.

- 4** Use the TAB [◀][▶] buttons to select one of the tabs (USER or USB) to which your settings will be saved.
- 5** Press the [6 ▼] (SAVE) button to save your file.
- 6** To recall your file, press the desired [F]–[I] button in the SETUP FILES display, then select the desired file.

If you want to call up the factory default files, select the file in the PRESET tab.

When the file is selected, a message is displayed according to the content of the file. Press the desired button.

RESET

This function lets you restore the status of the instrument to the original factory settings.

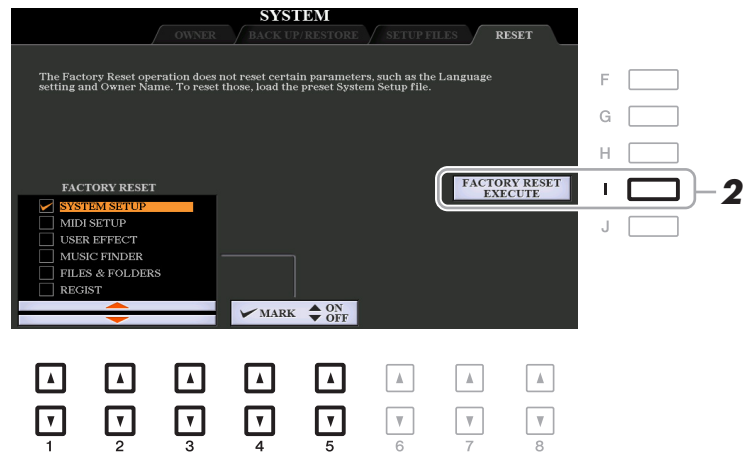

1 Use the [1 ▲▼]–[3 ▲▼] buttons to select the desired item then use the [4 ▲▼]/ [5 ▲▼] buttons to enter or remove the checkmark.

When an item is checkmarked, the corresponding parameters will be reset as described below:

SYSTEM SETUP	Resets the System Setup parameters to the original factory settings. Refer to the “Parameter Chart” in the Data List on the website for details about which parameters belong to System Setup.
MIDI SETUP	Resets the MIDI settings including the MIDI Setups on the USER tab display to the original factory status.
USER EFFECT	Resets the current Effect settings and the following data: <ul style="list-style-type: none"> • User Effect types page 107 • User Master EQ types page 110 • User Master Compressor types page 112 • User Microphone/Guitar settings page 89 • User Vocal Harmony/Synth Vocoder types (PSR-S970 only) pages 93, 98
MUSIC FINDER	Resets the Music Finder data (all Records) to the original factory settings.
FILES & FOLDERS	Deletes all files and folders including the Expansion folder stored in the USER tab display.
REGIST	Turns off all the Registration Memory [1]–[8] lamps, indicating that no Registration Memory Bank is selected although all the Registration Memory Bank files are maintained. In this status, you can create Registration Memory setups from the current panel settings. <p>NOTE The same operation can be done by turning the power on while holding the B5 key (rightmost B key). In this case, you can create Registration Memory setups from the default panel settings.</p>

2 Press the [I] (FACTORY RESET EXECUTE) button to carry out the Factory Reset operation for all checkmarked items.

Index

- A**
Access Point Mode 125
Any Key 56
Arpeggio 7
Arpeggio Hold 116, 128
Arpeggio Quantize 128
Arpeggio setting 128
- B**
Backup 130
Block Diagram 113
- C**
Carrier (Synth Vocoder) 100
Chord Fingering Type 25
Chorus 18, 106
Compressor 88, 111
- D**
Detune 96
Display 127
Drum Setup 46
DSP 18, 19, 106
Dynamics Control 28
- E**
Effect 7, 18, 106
Effect (Mixer) 105
EG (Envelope Generator) 18
EQ (Equalizer) 18, 19, 88, 109
Expansion Pack 22
- F**
Fade In/Out 126
Filter 17, 103
Fine-tuning 9
Follow Lights 56
Foot Controller 114
Foot Pedal 114
Footswitch 114
Formant 97
Format 129
Freeze 84
- G**
GM 5
Guide (Song) 55
- H**
Harmony 7
- I**
Infrastructure Mode 124
Instrument Info 23
- K**
Karao-Key 56
Knob 11
- L**
Language 55, 130
Live Control 11
Lyrics 52
- M**
Master Compressor 111
Master EQ 110
Metronome 127
MIDI setting 118
Modulation 17
Mono 16
Multi Pad Creator 75
Music Finder 79
- N**
Noise Gate 89
NTR (Note Transposition Rule) 43
NTT (Note Transposition Table) 43
- O**
One Touch Setting (OTS) 29
Organ Flutes Voice 20
OTS Link Timing 27
- P**
Pan (Vocal Harmony) 97
Panpot (Mixer) 102
Parameter Lock 129
Part EQ 109
Pedal 114
Performance Assistant Technology (P.A.T.) 57
Pitch 9, 104
Pitch Correct (Vocal Harmony) 97
Poly 16
Portamento 16
Punch In/Out (Song Creator) 66
- R**
Realtime Recording (Multi Pad) 75
Realtime Recording (Style) 32
Registration Memory 83
Registration Sequence 85
Repeat (Song) 54
Reset (System) 132
Restore 130
Reverb 18, 106
RTR (Retrigger Rule) 45
- S**
Scale Tuning 9
Score 49
Setup data (Song) 65
Setup file 131
Song Creator 58
Song setting 54
Source Chord 42
Source Root 42
Speaker 127
Step Recording (Multi Pad) 77
Step Recording (Song) 59, 62
Step Recording (Style) 36
Stop Accompaniment 27
Style Assembly 36
Style Creator 30
Style File Format (SFF) 41
Style Retrigger 13
Style setting 27
Synth Vocoder type 98

T

Talk	90
Tap Tempo	127
Text	52
Touch Response	6
Touch Sensitivity	6, 16
Transpose	10, 104
Transpose (Vocal Harmony)	95, 96
Tuning	9, 104

U

USB flash drive	129
-----------------------	-----

V

Vibrato	18
Vocal Harmony	91
Vocal Harmony type	93
Voice Set	15
Voice Set Filter	19
Volume (Mixer)	102
Volume (Vocal Harmony)	97

W

Wireless LAN	124
--------------------	-----

X

XG	5
----------	---

Y

Your Tempo	56
------------------	----