

PSS-F30

■ **DIGITAL KEYBOARD**

□ **Owner's Manual**

Thank you for purchasing this Yamaha Digital Keyboard!

This instrument is a portable keyboard featuring a wide variety of sounds and functions.

We recommend that you read this manual carefully so that you can fully take advantage of the advanced and convenient functions of the instrument. We also recommend that you keep this manual in a safe and handy place for future reference.

Before using the instrument, be sure to read "PRECAUTIONS" on pages 4-5.

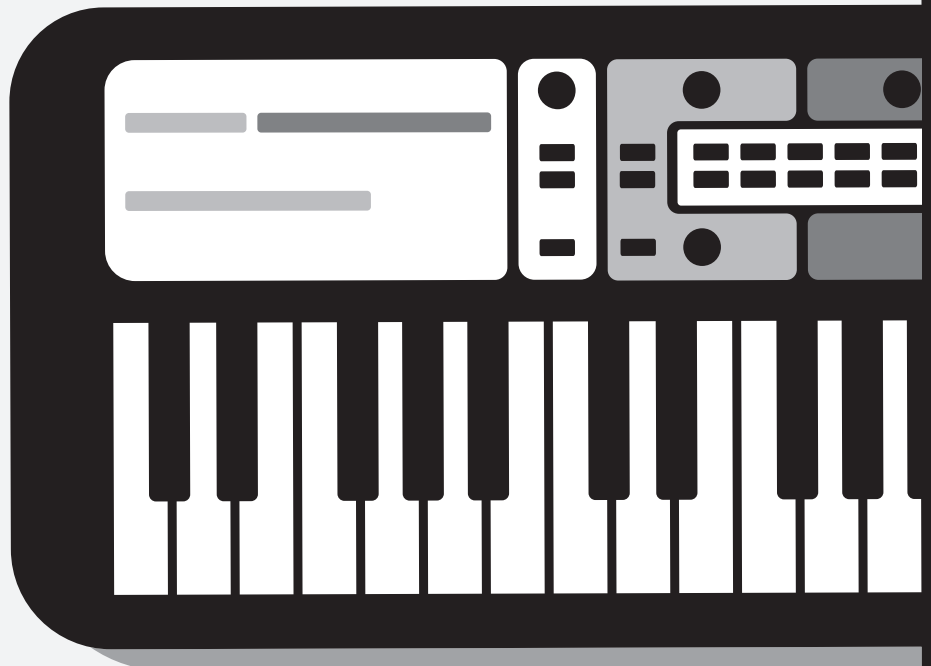

SPECIAL MESSAGE SECTION

This product utilizes batteries or an external power supply (adapter). DO NOT connect this product to any power supply or adapter other than one described in the manual, on the name plate, or specifically recommended by Yamaha.

WARNING: Do not place this product in a position where anyone could walk on, trip over, or roll anything over power or connecting cords of any kind. The use of an extension cord is not recommended! If you must use an extension cord, the minimum wire size for a 25' cord (or less) is 18 AWG. NOTE: The smaller the AWG number, the larger the current handling capacity. For longer extension cords, consult a local electrician.

This product should be used only with the components supplied or; a cart, rack, or stand that is recommended by Yamaha. If a cart, etc., is used, please observe all safety markings and instructions that accompany the accessory product.

SPECIFICATIONS SUBJECT TO CHANGE:

The information contained in this manual is believed to be correct at the time of printing. However, Yamaha reserves the right to change or modify any of the specifications without notice or obligation to update existing units.

This product, either alone or in combination with an amplifier and headphones or speaker/s, may be capable of producing sound levels that could cause permanent hearing loss. DO NOT operate for long periods of time at a high volume level or at a level that is uncomfortable. If you experience any hearing loss or ringing in the ears, you should consult an audiologist. IMPORTANT: The louder the sound, the shorter the time period before damage occurs.

Some Yamaha products may have benches and / or accessory mounting fixtures that are either supplied with the product or as optional accessories. Some of these items are designed to be dealer assembled or installed. Please make sure that benches are stable and any optional fixtures (where applicable) are well secured BEFORE using.

Benches supplied by Yamaha are designed for seating only. No other uses are recommended.

NOTICE:

Service charges incurred due to a lack of knowledge relating to how a function or effect works (when the unit is operating as designed) are not covered by the manufacturer's warranty, and are therefore the owners responsibility. Please study this manual carefully and consult your dealer before requesting service.

ENVIRONMENTAL ISSUES:

Yamaha strives to produce products that are both user safe and environmentally friendly. We sincerely believe that our products and the production methods used to produce them, meet these goals. In keeping with both the letter and the spirit of the law, we want you to be aware of the following:

Battery Notice:

This product MAY contain a small non-rechargeable battery which (if applicable) is soldered in place. The average life span of this type of battery is approximately five years. When replacement becomes necessary, contact a qualified service representative to perform the replacement.

This product may also use "household" type batteries. Some of these may be rechargeable. Make sure that the battery being charged is a rechargeable type and that the charger is intended for the battery being charged.

When installing batteries, never mix old batteries with new ones, and never mix different types of batteries. Batteries MUST be installed correctly. Mismatches or incorrect installation may result in overheating and battery case rupture.

Warning:

Do not attempt to disassemble, or incinerate any battery. Keep all batteries away from children. Dispose of used batteries promptly and as regulated by the laws in your area. Note: Check with any retailer of household type batteries in your area for battery disposal information.

Disposal Notice:

Should this product become damaged beyond repair, or for some reason its useful life is considered to be at an end, please observe all local, state, and federal regulations that relate to the disposal of products that contain lead, batteries, plastics, etc. If your dealer is unable to assist you, please contact Yamaha directly.

NAME PLATE LOCATION:

The name plate is located on the bottom of the product. The model number, serial number, power requirements, etc., are located on this plate. You should record the model number, serial number, and the date of purchase in the spaces provided below and retain this manual as a permanent record of your purchase.

Model

Serial No.

Purchase Date

PLEASE KEEP THIS MANUAL

FCC INFORMATION (U.S.A.)

1. IMPORTANT NOTICE: DO NOT MODIFY THIS UNIT!

This product, when installed as indicated in the instructions contained in this manual, meets FCC requirements. Modifications not expressly approved by Yamaha may void your authority, granted by the FCC, to use the product.

2. IMPORTANT: When connecting this product to accessories and/or another product use only high quality shielded cables. Cable/s supplied with this product MUST be used. Follow all installation instructions. Failure to follow instructions could void your FCC authorization to use this product in the USA.

3. NOTE: This product has been tested and found to comply with the requirements listed in FCC Regulations, Part 15 for Class "B" digital devices. Compliance with these requirements provides a reasonable level of assurance that your use of this product in a residential environment will not result in harmful interference with other electronic devices. This equipment generates/uses radio frequencies and, if not installed and used according to the instructions found in the users manual, may cause interference harmful to the operation of other electronic

devices. Compliance with FCC regulations does not guarantee that interference will not occur in all installations. If this product is found to be the source of interference, which can be determined by turning the unit "OFF" and "ON", please try to eliminate the problem by using one of the following measures: Relocate either this product or the device that is being affected by the interference.

Utilize power outlets that are on different branch (circuit breaker or fuse) circuits or install AC line filter/s.

In the case of radio or TV interference, relocate/reorient the antenna. If the antenna lead-in is 300 ohm ribbon lead, change the lead-in to co-axial type cable.

If these corrective measures do not produce satisfactory results, please contact the local retailer authorized to distribute this type of product. If you can not locate the appropriate retailer, please contact Yamaha Corporation of America, Electronic Service Division, 6600 Orangethorpe Ave, Buena Park, CA90620

The above statements apply ONLY to those products distributed by Yamaha Corporation of America or its subsidiaries.

* This applies only to products distributed by Yamaha Corporation of America.

(class B)

COMPLIANCE INFORMATION STATEMENT (Supplier's declaration of conformity procedure)

Responsible Party : Yamaha Corporation of America
Address : 6600 Orangethorpe Ave., Buena Park, Calif. 90620
Telephone : 714-522-9011
Type of Equipment : Digital Keyboard
Model Name : PSS-F30

This device complies with Part 15 of the FCC Rules.

Operation is subject to the following two conditions:

- 1) this device may not cause harmful interference, and
- 2) this device must accept any interference received including interference that may cause undesired operation.

* This applies only to products distributed by Yamaha Corporation of America.

(FCC SDoC)

The model number, serial number, power requirements, etc., may be found on or near the name plate, which is at the bottom of the unit.

You should note this serial number in the space provided below and retain this manual as a permanent record of your purchase to aid identification in the event of theft.

Model No.

Serial No.

(bottom_en_01)

PRECAUTIONS

PLEASE READ CAREFULLY BEFORE PROCEEDING

Please keep this manual in a safe and handy place for future reference.



WARNING

Always follow the basic precautions listed below to avoid the possibility of serious injury or even death from electrical shock, short-circuiting, damages, fire or other hazards. These precautions include, but are not limited to, the following:

Power supply

- Do not place the USB cable near heat sources such as heaters or radiators. Also, do not excessively bend or otherwise damage the cable, or place heavy objects on it.
- Only use the voltage specified as correct for the instrument. The required voltage is printed on the name plate of the instrument.
- Included USB cable is designed for use with only this instrument. Do not use for any other instrument.
- Check the plug periodically and remove any dirt or dust which may have accumulated on it.

Do not open

- This instrument contains no user-serviceable parts. Do not open the instrument or attempt to disassemble or modify the internal components in any way. If it should appear to be malfunctioning, discontinue use immediately and have it inspected by qualified Yamaha service personnel.

Water warning

- Do not expose the instrument to rain, use it near water or in damp or wet conditions, or place on it any containers (such as vases, bottles or glasses) containing liquids which might spill into any openings. If any liquid such as water seeps into the instrument, turn off the power immediately and disconnect the plug from the AC outlet. Then have the instrument inspected by qualified Yamaha service personnel.
- Never insert or remove a plug with wet hands.

Fire warning

- Do not put burning items, such as candles, on the unit. A burning item may fall over and cause a fire.

Influences on electro-medical devices

- Magnetism may affect electro-medical devices.
 - Do not use this product near medical devices or inside areas in which the use of radio waves is restricted.
 - Do not use this product within 15cm (6 in.) of persons with a heart pacemaker or defibrillator implant.

Battery

- Follow the precautions below. Failure to do so might result in explosion, fire, overheating or battery fluid leakage.
 - Do not tamper with or disassemble batteries.
 - Do not dispose of batteries in fire.
 - Do not attempt to recharge batteries that are not designed to be charged.
 - Keep the batteries separate from metallic objects such as necklaces, hairpins, coins, and keys.
 - Use the specified battery type (page 11) only.
 - Use new batteries, all of which are the same type, same model, and made by the same manufacturer.
 - Always make sure all batteries are inserted in conformity with the +/- polarity markings.
 - When the batteries run out, or if the instrument is not to be used for a long time, remove the batteries from the instrument.
 - When using Ni-MH batteries, follow the instructions that came with the batteries. Use only the specified charger device when charging.
- Keep batteries away from small children who might accidentally swallow them.
- If the batteries do leak, avoid contact with the leaked fluid. If the battery fluid should come in contact with your eyes, mouth, or skin, wash immediately with water and consult a doctor. Battery fluid is corrosive and may possibly cause loss of sight or chemical burns.

If you notice any abnormality

- When one of the following problems occur, immediately turn off the power switch and disconnect the plug from the outlet. (If you are using batteries, remove all batteries from the instrument.) Then have the device inspected by Yamaha service personnel.
 - The USB cable or plug becomes frayed or damaged.
 - It emits unusual smells or smoke.
 - Some object has been dropped into the instrument.
 - There is a sudden loss of sound during use of the instrument.
 - If any cracks or breakages exist on the instrument.



CAUTION

Always follow the basic precautions listed below to avoid the possibility of physical injury to you or others, or damage to the instrument or other property. These precautions include, but are not limited to, the following:

Power supply

- Use the specified USB power adaptor (page 6) only. Using the wrong adaptor can result in damage to the instrument or overheating.
- Do not connect the instrument to an electrical outlet using a multiple-connector. Doing so can result in lower sound quality, or possibly cause overheating in the outlet.
- When removing the plug from the instrument or an outlet, always hold the plug itself and not the USB cable. Pulling by the cable can damage it.
- Remove the plug from the outlet when the instrument is not to be used for extended periods of time, or during electrical storms.

Location

- Do not place the instrument in an unstable position where it might accidentally fall over.
- Before moving the instrument, remove all connected cables, to prevent damage to the cables or injury to anyone who might trip over them.
- When setting up the product, make sure that the AC outlet you are using is easily accessible. If some trouble or malfunction occurs, immediately turn off the power switch and disconnect the plug from the outlet. Even when the power switch is turned off, electricity is still flowing to the product at the minimum level. When you are not using the product for a long time, make sure to disconnect the plug from the wall AC outlet.

Connections

- Before connecting the instrument to other electronic components, turn off the power for all components. Before turning the power on or off for all components, set all volume levels to minimum.
- Be sure to set the volumes of all components at their minimum levels and gradually raise the volume controls while playing the instrument to set the desired listening level.

Handling caution

- Do not insert a finger or hand in any gaps on the instrument.
- Never insert or drop paper, metallic, or other objects into the gaps on the panel or keyboard. This could cause physical injury to you or others, damage to the instrument or other property, or operational failure.
- Do not rest your weight on, or place heavy objects on the instrument, and do not use excessive force on the buttons, switches or connectors.
- Do not use the instrument/device or headphones for a long period of time at a high or uncomfortable volume level, since this can cause permanent hearing loss. If you experience any hearing loss or ringing in the ears, consult a physician.

Yamaha cannot be held responsible for damage caused by improper use or modifications to the instrument, or data that is lost or destroyed.

Always turn the power off when the instrument is not in use.

Even when the [] (Standby/On) switch is in standby status (display is off), electricity is still flowing to the instrument at the minimum level.

When you are not using the instrument for a long time, make sure you disconnect the plug from the wall AC outlet.

Make sure to discard used batteries according to local regulations.

DMI-7 2/2

NOTICE

To avoid the possibility of malfunction/ damage to the product, damage to data, or damage to other property, follow the notices below.

■ Handling

- Do not use the instrument in the vicinity of a TV, radio, stereo equipment, mobile phone, or other electric devices. Otherwise, the instrument, TV, or radio may generate noise.
- Do not expose the instrument to excessive dust or vibrations, or extreme cold or heat (such as in direct sunlight, near a heater, or in a car during the day) to prevent the possibility of panel disfiguration, damage to the internal components or unstable operation. (Verified operating temperature range: 5° – 40°C, or 41° – 104°F.)
- Do not place vinyl, plastic or rubber objects on the instrument, since this might discolor the panel or keyboard.

■ Maintenance

- When cleaning the instrument, use a soft and dry cloth. Do not use paint thinners, solvents, alcohol, cleaning fluids, or chemical-impregnated wiping cloths.

■ Saving data

- Some of the data of this instrument (page 11) are retained when the power is turned off. However, the saved data may be lost due to some failure, an operation mistake, etc.

Information

■ About copyrights

- Copying of the commercially available musical data including but not limited to MIDI data and/or audio data is strictly prohibited except for your personal use.
- This product incorporates and bundles contents in which Yamaha owns copyrights or with respect to which Yamaha has license to use others' copyrights. Due to copyright laws and other relevant laws, you are NOT allowed to distribute media in which these contents are saved or recorded and remain virtually the same or very similar to those in the product.

* The contents described above include a computer program, Accompaniment Style data, MIDI data, WAVE data, voice recording data, a score, score data, etc.

* You are allowed to distribute medium in which your performance or music production using these contents is recorded, and the permission of Yamaha Corporation is not required in such cases.

■ About functions/data bundled with the instrument

- Some of the preset songs have been edited for length or arrangement, and may not be exactly the same as the original.

■ About this manual

- The illustrations and displays as shown in this manual are for instructional purposes only, and may appear somewhat different from those on your instrument.
- The company names and product names in this manual are the trademarks or registered trademarks of their respective companies.

Included Accessories

- Owner's Manual (this book) (1)
- USB cable (1)
- Online Member Product Registration (1)

Song Book (Online Material)

Contains music scores for the preset Songs (excluding Song No. 001) of this instrument. To obtain this Song Book, access the Yamaha website, and click on the "Download" tab beneath the model name.



Song Book

Connecting Headphones or External Audio Equipment (PHONES/OUTPUT Jack)

CAUTION

- Before using the headphones, be sure to set the volume of the instrument at the minimum level. Then gradually raise the volume while playing the instrument, for your ear comfort and safety.

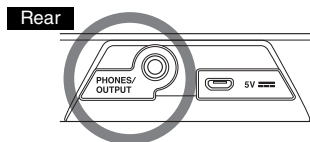

For connecting a set of stereo headphones with a stereo mini plug. This jack also functions as an external output to output for sending the audio signal of this instrument to external audio equipment. The speakers of the instrument are automatically shut off when a headphones plug, etc. is inserted into this jack.

CAUTION

- Do not use the instrument or headphones for a long period of time at a high or uncomfortable volume level, since this can cause permanent hearing loss.
- Before connecting the instrument to other electronic components, make sure to set all volume levels to minimum, then turn off the power of all the components. Otherwise, damage to the components or electrical shock may occur.

NOTICE

- To avoid possible damage to the external device, first turn on the power to the instrument, then to the external device. When turning off the power, do so in reverse order: first turn off the power to the external device, then to the instrument.

Setting Up

Depending on how you are powering your instrument, follow one of the two power supply instructions below. The PSS-F30 does not include power supply accessories (with the exception of the USB cable), so make sure to purchase them separately as required.

NOTICE

- Using a USB cable other than the one included (or playing the instrument at a high volume) may result in degraded sound. If this happens, make sure to use the included USB cable (or turn down the master volume as needed).

1 Using a USB power adaptor or USB mobile battery, etc.

Connect the included USB cable and the commercially available USB power adaptor (or USB mobile battery) in the order shown in the illustration.

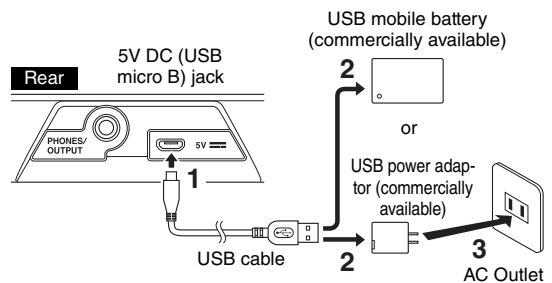

The shape of the plug and outlet differs depending on your locale.

When disconnecting the USB cable or so, first turn off the power, then follow the order shown above in reverse.

USB Power adaptor / USB mobile battery requirements

- Output voltage: 4.8 V to 5.2 V
- Output current: 0.5 A or greater

CAUTION

- Make sure to use a USB power adaptor or USB mobile battery with the specifications above. Using the wrong USB power adaptor can result in damage to the instrument or overheating. Read the safety precautions for your particular USB power adaptor or USB mobile battery.

NOTICE

- Some USB mobile batteries automatically stop supplying power when connected to a device with low current consumption, such as this instrument. Use a USB mobile battery that has a low-current mode function, etc., and can supply power to devices with current consumption of 40 mA or less.

2 Using Batteries

This instrument requires four “AA” size, Alkaline (LR6)/Manganese (R6) batteries, or rechargeable nickel-metal hydride batteries (rechargeable Ni-MH batteries). The Alkaline batteries or rechargeable Ni-MH batteries are recommended for this instrument, since other types may result in poorer battery performance.

⚠ WARNING

- See the “Battery” section in the Precautions (page 4).

- 1 Make sure that the power of the instrument is off.
- 2 Open the battery compartment cover located on the instrument’s bottom panel.

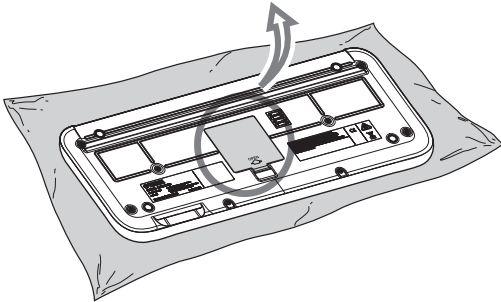
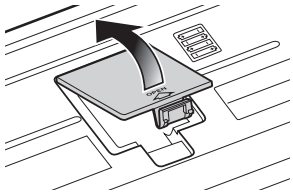

- 3 Insert the four new batteries, being careful to follow the polarity markings on the inside of the compartment.

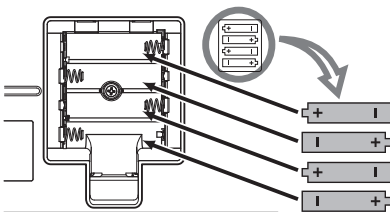

- 4 Replace the compartment cover, making sure that it locks firmly in place.

NOTICE

- Make sure to set the Battery Type correctly (page 10). Failure to set the battery type may shorten the amount of the battery life.
- Connecting or disconnecting the USB cable with batteries installed may turn the power off, resulting in loss of data.

Turning the Power On/Standby

Press the [⏻] (Standby/On) switch to turn the power on; the display lights.

Hold down the [⏻] (Standby/On) switch for about one second to set the power of the instrument to standby.

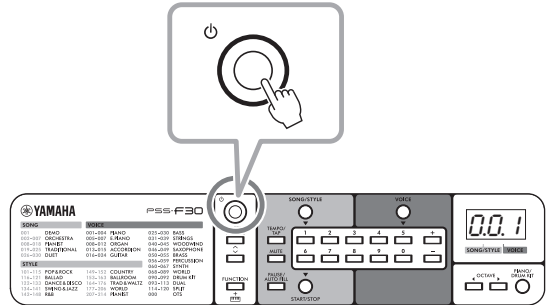

Adjust the Master Volume

This instrument has a Volume Limit function to prevent the Master Volume from accidentally being set to too high a level. For the operation, see “Volume Limit” on page 10.

Use the MASTER VOLUME buttons.

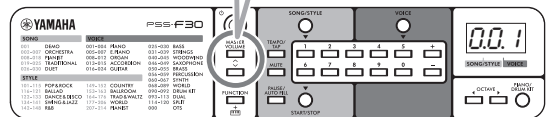
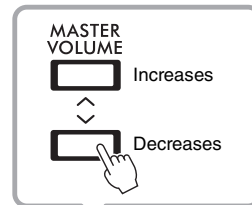

Volume range: 00–15 (default 13).



NOTE

- Volume setting will be reset to the default value 13 when “Initialization” (page 11) is done.

Selecting and Playing a Voice, Song or Style

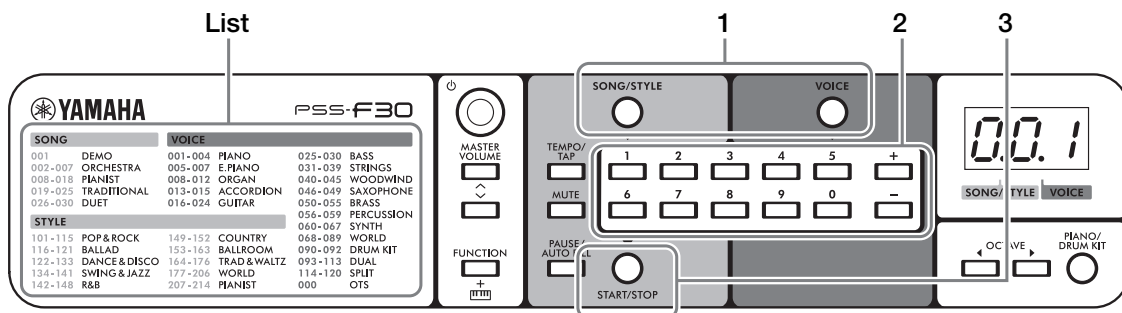

The list appearance may be different depending on your area.

Voices

The Voices are the heart of the PSS-F30, letting you play 120 realistic instrument sounds from the keyboard.

➤➤ To see how the score relates to the keyboard, see page 16.

➤➤ To select and play a Voice, see Steps 1, 2 and 3!

Select the OTS (One Touch Setting) Voice (Voice 000.) When this is called up and you select a Style or Song, the instrument automatically selects the most appropriate Voice for playing with that Style or Song. To turn this function off select another Voice.

Use the buttons below to match the Voice to the music you want to play!

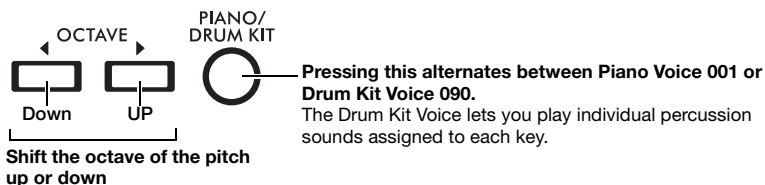

Songs

The Songs show you just how powerful the instrument is, with 30 specially recorded pieces—for playing and practicing along with, or just for listening.

➤➤ Download the free Digital Song Book and have fun practicing the Songs! (See page 6.)

➤➤ To select and play a Song, see Steps 1, 2 and 3!

Starting Song playback plays all songs one-by-one in succession repeatedly, until you manually stop them.

Use the buttons below to control playback as desired.

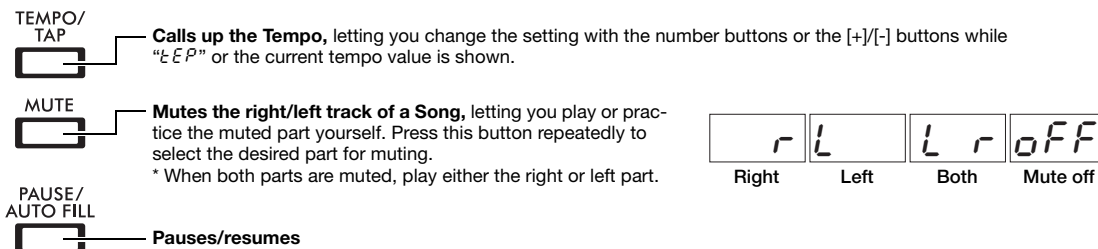

When you practice, you may need to shift the octave of the pitch up or down. If so, use the OCTAVE buttons described in the Voice section above.

Steps 1, 2 and 3!

1. To use a Voice, press the [VOICE] button.

To use a Song or Style, press the [SONG/STYLE] button.

This dot lights to indicate a Song or Style number.



This dot lights to indicate a Voice number.

2. Use the Numbers buttons and [+]/[-] buttons to select a desired number: Voices 000–120, Songs 001–030 and Styles 101–214. See the list on the left side of the panel for quick reference.

3. If you've selected a Voice, play it from the keyboard. If you've selected a Song or Style, play it by pressing the [START/STOP] button. To stop the Song or Style, press the button again.

* In these steps, Style playback only has the rhythm part. If you select a PIANIST Style (which has no rhythm), simply play a note in the Accompaniment section of the keyboard to play back other accompaniment parts.

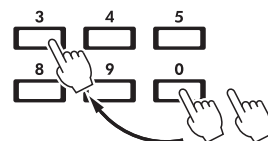

For example, to select number 003, press the buttons 0, 0, 3 in succession.

Styles

The Styles add excitement to your performance—giving you authentic, automatic backing in a wide variety of music genres. Just play the root notes of chords with your left hand, and enjoy the accompaniment of a full band behind you!

>> Score for Smart Chord experience is provided on page 17.

>> To select and play a Style, see Steps 1, 2 and 3!

To properly play a Style and hear the backing parts, you'll need to play a key in the accompaniment section of the keyboard while the rhythm is playing.

Try playing the root notes of chords with your left hand while you play a melody over the accompaniment with your right.

Mary Had a Little Lamb

Right hand

Left hand

To play the backing yourself, you need know chords—but the Smart Chord function does that work for you! Simply play the root note of the chord, and the appropriate chord plays according to the key. For best results, set the Smart Chord Key (page 10).

If you are familiar with chord fingerings and want to play full chords instead of just the root notes, set the Fingering Type on page 10 to “Multi.”

In Style playback, use the buttons below as desired.

TEMPO/
TAP



Calls up the Tempo, letting you change the setting with the number buttons or the [+]/[-] buttons while “T E P” or the current tempo value is shown.

MUTE



Mutes the accompaniment part so that you play only with the rhythm part. To restore the accompaniment, press it again and play a key in the Accompaniment section.

PAUSE/
AUTO FILL



Plays Fill In, to add rhythmic interest to your performance.
* The PIANIST category Styles have no Fill sections.

>> To exit from the Style mode and use the Voice over the whole range, select Song.

The Functions



To set the various Functions, press the appropriate key (repeatedly if necessary) while holding down **FUNCTION**.

①	②	③	④	⑤	⑥	⑦	⑧	⑨	⑩	⑪	⑫
SUSTAIN	TRANSPOSE	TUNING	ON/OFF	METRONOME	SONG/STYLE VOLUME	SYNC START	CHORD FINGERING	SMART CHORD KEY	BATTERY TYPE	AUTO POWER OFF	VOLUME LIMIT
On/Off	-1	-0.2	On/Off	-1	-1	On/Off	Smart Chord / Multi Finger	Alkaline / Rechargeable	Off/5/10/15/30/60/120	-1	Default
C#2	D#2	F#2	G#2	A#2	C#3	D#3	F#3	G#3	A#3	C#4	D#4
C2	D2	F2	G2	A2	C3	D3	F3	G3	A3	C4	D4

(The Lowest Key)

Function List

Function Name	Descriptions	Default Value	Range/Settings
① Sustain	Switches the Sustain function on/off.	Off (SoF)	On (Son) / Off (SoF)
② Transpose	Determines the pitch of the instrument in semitone increments.	00	-12-0-12
③ Tuning	Determines the fine tuning of the pitch of the entire instrument in approx. 0.2Hz increments. The hundreds digit of the setting value is omitted on the display.	440.0	427.0(2 70)-440.0(400)-453.0(530)
④ Metronome	Switches the Metronome function on/off.	Off (oFF)	On (on) / Off (oFF)
⑤ Metronome Beat	Determines the Metronome beat. For example, when this is set to 4, the beat is set to 4/4 time and the first beat is accented with a bell sound.	The current Song or Style Beat	0 (no beat)-16
⑥ Song/Style/Metronome Volume	Determines the Song/Style/Metronome volume.	12	00-15
⑦ Sync Start	Switches the Sync Start function on/off. When this function is on, the Song/Style number on the display flashes and you can start the Song/Style by simply playing a key. For Styles, press a key in the Accompaniment section, or any key when the Mute function is on (page 9).	Off	On (Song/Style No. on the display flashes.) / Off
⑧ Chord Fingering Type	Determines how to play the chord in Accompaniment Section (page 9) when playing with a Style. <ul style="list-style-type: none"> Smart Chord (S#r): Play only the root key of the chord. Multi (rlt): Play all notes of the chord conventionally. When Multi is selected, the Accompaniment section is C2-F#3.	Smart Chord (S#r)	Smart Chord (S#r) / Multi (rlt)
⑨ Smart Chord Key	Determines the Key Signature when the Chord Fingering Type is set to "Smart Chord." For example, if the music score shows 1 flat (b), press the A3 or G3 key until "FL1" appears on the display. A complete score is provided on page 17. <p>Key Signature (Key in F major)</p>	No Key Signature (SP0: C Major or A Minor)	7 Flats (FL 7)-0 (SP0)-7 Sharps (SP 7)
⑩ Battery Type	Selects the type of batteries you have installed to this instrument.	Alkaline battery / Manganese battery (AL)	AL: Alkaline battery / Manganese battery ri: Rechargeable battery
⑪ Auto Power Off	Specifies the time that will elapse before the instrument's power is automatically turned off.	30 minutes	oFF/5/10/15/30/60/120 (minutes)
⑫ Volume Limit	Determines the maximum value of the Master Volume.	15	01-15

Tip – [TEMPO/TAP] button

You can start a Style or Song at a desired speed by simply tapping the [TEMPO/TAP] button four times for time signatures in 4 (such as 4/4) or three times for time signatures in 3 (such as 3/4).

Also, you can change the tempo by tapping the [TEMPO/TAP] button just twice at the desired tempo while a Song, Style or Metronome is playing back.

Backup and Initialization

Backup Parameters

The following settings will be maintained even if the power is turned off.

Master Volume, Volume Limit, Tuning, Chord Fingering Type, Auto Power Off, Battery Type

NOTICE

- The power is turned off when the USB power adaptor is unplugged with the power on or the alkaline / manganese battery runs down.

Initialization

You can initialize the backup parameters via the following method.

While holding down the highest white key, press the  (Standby/On) switch to turn the power on. “*℄ L r*” appears on the display.

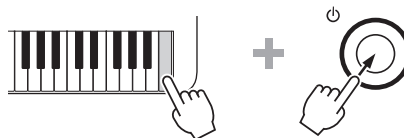

Troubleshooting

Problem	Solution
<ul style="list-style-type: none">• No Sound.• The volume is too soft.	<ul style="list-style-type: none">• Increase the volume.• Disconnect the headphones from [PHONES/OUTPUT] jack (page 6).• Check whether the Volume Limit setting (page 10) is too low or not.• Replace all the batteries with new ones or recharged ones.
The sound is degraded or choppy.	Use the included USB cable or turn down the master volume.
Power suddenly and unexpectedly turns off.	This is normal and the Auto Power Off function may have been activated (page 10). If you need to disable the Auto Power Off function, select “ <i>oFF</i> .”
When the instrument is turned on, power is turned off suddenly and unexpectedly.	The protection circuit has been activated due to overcurrent. This may occur when your USB power adaptor does not meet the requirements on page 6 or is damaged. Try to use another USB power adaptor that meets the requirements, etc. If it should appear to be malfunctioning, please consult Yamaha service personnel.

Specifications

Product Name	Digital keyboard
Keyboard	37 HQ (High Quality) Mini Keys
Voices	<ul style="list-style-type: none">• Preset: 117 Voices + 3 Drum Kits• Polyphony (Max.): 32 notes
Octave Button	Yes (-01 – +01)
Accompaniment Styles	<ul style="list-style-type: none">• Preset: 114• Style Controls: Main, Fill-in• Fingering: Smart Chord, Multi Finger
Songs	Preset: 30
Function	<ul style="list-style-type: none">• Panel Sustain: Yes• Metronome: Yes• Tempo Range: 11–280• Transpose: -12–0→+12• Tuning: 427.0–440.0–453.0 Hz (approx. 0.2 Hz increments)
Display	LED display
Panel Language	English
Connectivity	Headphones/Output (stereo mini) jack, 5V DC (USB micro B) terminal
Amplifiers	1.4W
Speakers	8cm x 1

Power Supply	<ul style="list-style-type: none">• USB power adaptor 5V/500mA• Four “AA” size alkaline (LR6), manganese (R6) or Ni-MH rechargeable (HR6) batteries
Power Consumption	1.5W
Auto Power Off	Yes
Dimensions (W x D x H)	506 mm x 201 mm x 54 mm (19-15/16” x 7-15/16” x 2-1/8”)
Weight	1.2 kg (2 lb, 10 oz) (not including batteries)
Included Accessories	Owner’s Manual, USB cable, Online Member Product Registration
Separately Sold Accessories (May not be available depending on your area.)	Headphones (HPH-50/HPH-100/HPH-150)

* The contents of this manual apply to the latest specifications as of the publishing date. To obtain the latest manual, access the Yamaha website then download the manual file. Since specifications, equipment or separately sold accessories may not be the same in every locale, please check with your Yamaha dealer.

Voice List

Voice No.	Voice Name
PIANO	
1	Grand Piano
2	Bright Piano
3	Honky Tonk Piano
4	Harpsichord
E.PIANO	
5	Electric Piano 1
6	Electric Piano 2
7	Electric Grand
ORGAN	
8	Drawbar Organ
9	Percussive Organ
10	Rock Organ
11	Pipe Organ
12	Reed Organ
ACCORDION	
13	Accordion
14	Tango Accordion
15	Harmonica
GUITAR	
16	Nylon Guitar
17	Steel Guitar
18	12Strings Guitar
19	Jazz Guitar
20	Clean Guitar
21	Muted Guitar
22	Overdriven Guitar
23	Distortion Guitar
24	Ukulele
BASS	
25	Acoustic Bass
26	Finger Bass
27	Pick Bass
28	Fretless Bass
29	Slap Bass
30	Synth Bass
STRINGS	
31	Strings 1
32	Strings 2
33	Synth Strings
34	Pizzicato Strings
35	Violin
36	Viola
37	Cello
38	Contrabass
39	Orchestral Harp
WOODWIND	
40	Flute
41	Piccolo
42	Recorder
43	Oboe
44	Clarinet
45	Bassoon
SAXOPHONE	
46	Tenor Sax
47	Alto Sax
48	Soprano Sax
49	Baritone Sax
BRASS	
50	Brass Section
51	Trumpet
52	Trombone

Voice No.	Voice Name
53	French Horn
54	Tuba
55	Synth Brass
PERCUSSION	
56	Vibraphone
57	Marimba
58	Celesta
59	Timpani
SYNTH	
60	Square Lead
61	Sawtooth Lead
62	Bass & Lead
63	New Age Pad
64	Warm Pad
65	Halo Pad
66	Crystal
67	Brightness
WORLD	
68	Pan Flute
69	Ocarina
70	Banjo
71	Kalimba
72	Bagpipe
73	Dulcimer 1
74	Dulcimer 2
75	Harmonium 1 (Single Reed)
76	Harmonium 2 (Double Reed)
77	Harmonium 3 (Triple Reed)
78	Sitar
79	Detuned Sitar
80	Shehnai
81	Tabla
82	Indian Kit
83	Oud
84	Rabab
85	Kanoon
86	Arabic Kit
87	Er Hu
88	Yang Qin
89	Koto
DRUM KIT	
90	Standard Kit
91	Brush Kit
92	Dance Kit
DUAL*	
93	Octave Piano
94	Piano & Strings
95	Piano Pad
96	E.Piano Pad
97	Octave Harpsichord
98	Full Organ
99	Octave Strings
100	Octave Pizzicato
101	Strings & Flute
102	Strings Pad
103	Flute & Clarinet
104	Oboe & Bassoon
105	Alto Sax & Tenor Sax
106	Octave Brass
107	Power Brass
108	Jazz Section
109	Orchestra Tutti

Voice No.	Voice Name
110	Trumpet & Trombone
111	Fat Lead
112	Bell Mixture
113	Bell Pad
SPLIT**	
114	Piano / A.Bass
115	E.Piano / E. Bass
116	Brass / Tuba
117	Trumpet / Trombone
118	Flute / Oboe / Clarinet / Bassoon
119	Soprano / Alto / Tenor / Baritone Sax
120	Trumpet / Horn / Trombone / Tuba

* When you select a Voice of the DUAL category, two voices sound at the same time.

** When you select a Voice of SPLIT category, different Voices sound from specific keyboard sections.

Drum Kit List

Voice No.	90	91	92	86	82
Keyboard Note	Standard Kit	Brush Kit	Dance Kit	Arabic Kit	Indian Kit
C 1	Finger Snap			Khaligi Clap 1	Baya ge
C# 1	Brush Tap			Zarb Back mf	Baya ke
D 1	Brush Swirl			Khaligi Clap 2	Baya ghe
D# 1	Brush Slap			Arabic Zalgouta Close	Baya ka
E 1	Brush Tap Swirl		Reverse Cymbal	Arabic Hand Clap	Tabla na
F 1	Snare Roll			Tabel Tak 1	Tabla tin
F# 1	Castanet			Sagat 1	Tablabaya dha
G 1	Snare Soft	Brush Slap 2	Snare Techno	Tabel Dom	Dhol 1 Open
G# 1	Surdo Open			Sagat 2	Dhol 1 Slap
A 1	Bass Drum Soft		Kick Techno Q	Tabel Tak 2	Dhol 1 Mute
A# 1	Open Rim Shot		Rim Gate	Sagat 3	Dhol 1 Open Slap
B 1	Bass Drum Hard		Kick Techno L	Riq Tik 3	Dhol 1 Roll
C 2	Bass Drum	Bass Drum Jazz	Kick Techno	Riq Tik 2	Dandia Short
C# 2	Side Stick		Side Stick Analog	Riq Tik Hard 1	Dandia Long
D 2	Snare	Brush Slap 3	Snare Clap	Riq Tik 1	Chutki
D# 2	Hand Clap			Riq Tik Hard 2	Chipri
E 2	Snare Tight	Brush Tap	Snare Dry	Riq Tik Hard 3	Khanjira Open
F 2	Floor Tom L	Tom Brush 1	Tom Analog 1	Riq Tish	Khanjira Slap
F# 2	Hi-Hat Closed		Hi-Hat Close Analog 1	Riq Snouj 2	Khanjira Mute
G 2	Floor Tom H	Tom Brush 2	Tom Analog 2	Riq Roll	Khanjira Bendup
G# 2	Hi-Hat Pedal		Hi-Hat Close Analog 2	Riq Snouj 1	Khanjira Benddown
A 2	Low Tom	Tom Brush 3	Tom Analog 3	Riq Sak	Dholak 1 Open
A# 2	Hi-Hat Open		Hi-Hat Open Analog	Riq Snouj 3	Dholak 1 Mute
B 2	Mid Tom L	Tom Brush 4	Tom Analog 4	Riq Snouj 4	Dholak 1 Slap
C 3	Mid Tom H	Tom Brush 5	Tom Analog 5	Riq Tak 1	Dhol 2 Open
C# 3	Crash Cymbal 1		Cymbal Analog	Riq Brass 1	Dhol 2 Slap
D 3	High Tom	Tom Brush 6	Tom Analog 6	Riq Tak 2	Dhol 2 Rim
D# 3	Ride Cymbal 1			Riq Brass 2	Hand Clap
E 3	Chinese Cymbal			Riq Dom	Mridangam din
F 3	Ride Cymbal Cup			Zarb Tom f	Mridangam ki
F# 3	Tambourine			Katem Dom	Mridangam ta
G 3	Splash Cymbal			Katem Sak 1	Dafli Open
G# 3	Cowbell			Katem Tak 1	Dafli Slap
A 3	Crash Cymbal 2			Katem Sak 2	Dafli Rim
A# 3	Vibraslap			Katem Tak 2	Chimta Normal
B 3	Ride Cymbal 2			Daholla Sak 2	Chimta Ring
C 4	Bongo H			Daholla Sak 1	Dholki Hi Open
C# 4	Bongo L			Daholla Tak 1	Dholki Hi Mute
D 4	Conga H Mute		Conga Analog H	Daholla Dom	Dholki Lo Open
D# 4	Conga H Open		Conga Analog M	Daholla Tak 2	Dholki Hi Slap
E 4	Conga L		Conga Analog L	Zarb Eshareh	Dholki Lo Slide
F 4	Timbale H			Tablah Dom 2	Dholak 2 Open
F# 4	Timbale L			Tablah Roll of Edge	Dholak 2 Slide
G 4	Agogo H			Tablah Tak Finger 4	Dholak 2 Rim 1
G# 4	Agogo L			Tablah Tak Trill 1	Dholak 2 Rim 2
A 4	Cabasa			Tablah Tak Finger 3	Dholak 2 Ring
A# 4	Maracas			Tablah Tak Trill 2	Jhanji Open
B 4	Metronome Click			Tablah Tak Finger 2	Dholak 2 Slap
C 5	Metronome Bell			Tablah Tak Finger 1	Mondira Open
C# 5	Guiro Short			Tablah Tik 2	Mondira Close
D 5	Guiro Long			Tablah Tik 4	Tabla C
D# 5	Claves			Tablah Tik 3	Tabla F
E 5	Wood Block H			Tablah Tik 1	Tabla G
F 5	Wood Block L			Tablah Tak 3	Tabla B
F# 5	Scratch H			Tablah Tak 1	Khomokh Normal
G 5	Scratch L			Tablah Tak 4	Duff Open
G# 5	Triangle Mute			Tablah Tak 2	Hatheli Long
A 5	Triangle Open			Tablah Sak 2	Hatheli Short
A# 5	Shaker			Tablah Tremolo	Thavil Slap
B 5	Jingle Bells			Tablah Sak 1	Thavil Mute
C 6	Bell Tree			Tablah Dom 1	Khartaal

: Same as "Standard Kit".

Style List

Style No.	Style Name
POP & ROCK	
101	8BeatModern
102	60sGuitarPop
103	60s8Beat
104	8Beat
105	OffBeat
106	60sRock
107	HardRock
108	RockShuffle
109	8BeatRock
110	16Beat
111	PopShuffle
112	GuitarPop
113	16BeatUptempo
114	KoolShuffle
115	HipHopLight
BALLAD	
116	PianoBallad
117	6/8ModernEP
118	6/8SlowRock
119	OrganBallad
120	PopBallad
121	16BeatBallad
DANCE & DISCO	
122	EuroTrance
123	Ibiza
124	SwingHouse
125	Clubdance
126	ClubLatin
127	Garage
128	TechnoParty
129	HipHopGroove
130	70sDisco
131	LatinDisco
132	SaturdayNight
133	DiscoHands
SWING & JAZZ	
134	BigBandFast
135	JazzBallad
136	JazzClub
137	Swing 1
138	Swing 2
139	Five/Four
140	Dixieland
141	Ragtime
R&B	
142	Soul
143	DetroitPop
144	6/8Soul
145	CrocoTwist
146	Rock&Roll

Style No.	Style Name
147	ComboBoogie
148	6/8Blues
COUNTRY	
149	CountryPop
150	CountrySwing
151	Country2/4
152	Bluegrass
BALLROOM	
153	VienneseWaltz
154	EnglishWaltz
155	Slowfox
156	Foxtrot
157	Quickstep
158	Tango
159	Pasodoble
160	Samba
161	ChaChaCha
162	Rumba
163	Jive
TRAD & WALTZ	
164	March
165	6/8March
166	PolkaPop
167	Tarantella
168	Showtune
169	ChristmasSwing
170	ChristmasWaltz
171	ScottishReel
172	Waltz
173	SwingWaltz
174	JazzWaltz
175	CountryWaltz
176	Musette
WORLD	
177	BrazilianSamba
178	BossaNova
179	Forro
180	Sertanejo
181	Mambo
182	Salsa
183	Beguine
184	Reggae
185	Tijuana
186	PasoDuranguense
187	CumbiaGrupera
188	Joropo
189	Parranda
190	ModernDangdut
191	Keroncong
192	Bhajan
193	BollyMix

Style No.	Style Name
194	IndianPop
195	HindBallad
196	IndyWaltz
197	Bhangra
198	Kerala
199	Rajasthan
200	Dandiya
201	Qawwali
202	Saeidy
203	WehdaSaghira
204	Laff
205	IranianElec
206	Emarati
PIANIST	
207	Stride
208	PianoSwing
209	Arpeggio
210	Habanera
211	SlowRock
212	8BeatPianoBallad
213	6/8PianoMarch
214	PianoWaltz

Song List

Category	Song No.	Song Name	Composer
DEMO	1	Demo	Original
ORCHESTRA	2	Danse des Mirlitons from "The Nutcracker"	P. I. Tchaikovsky
	3	"Orphée aux Enfers" Ouverture	J. Offenbach
	4	Slavonic Dances No.10	A. Dvořák
	5	Méditation (Thaïs)	J. Massenet
	6	Frühlingslied	F. Mendelssohn
	7	"The Surprise" Symphony	F. J. Haydn
PIANIST	8	La candeur	J. F. Burgmüller
	9	Arabesque	J. F. Burgmüller
	10	Pastorale	J. F. Burgmüller
	11	Innocence	J. F. Burgmüller
	12	Etude op.10-3 "Chanson de l'adieu"	F. Chopin
	13	Valse op.64-1 "Petit Chien"	F. Chopin
	14	Menuett	L. Boccherini
	15	Moments Musicaux op.94-3	F. Schubert
	16	Prelude (Wohltemperierte Klavier 1-1)	J. S. Bach
	17	La Violette	L. Streabbog
TRADITIONAL	18	Für Elise	L. v. Beethoven
	19	America the Beautiful	S. A. Ward
	20	Londonderry Air	Traditional
	21	Wenn ich ein Vöglein wär	Traditional
	22	Die Lorelei	F. Silcher
	23	Turkey in the Straw	Traditional
	24	Muss i denn	F. Silcher
25	To a Wild Rose	E. A. MacDowell	
DUET	26	We Wish You A Merry Christmas (DUET)	Traditional
	27	Ten Little Indians (DUET)	Traditional
	28	Twinkle Twinkle Little Star (DUET)	Traditional
	29	The Cuckoo (DUET)	Traditional
	30	O du lieber Augustin (DUET)	Traditional

- Some songs have been edited for length or for ease in learning, and may not be exactly the same as the original.
- A song book (free downloadable scores) is available that includes scores for all internal songs (excepting Song 1). To obtain this Song Book, access the Yamaha website, and click on the "Download" tab beneath the model name.

Reading the Score

◇ The Keyboard, Staff Lines, and Clef

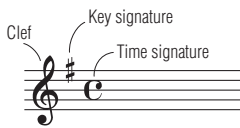
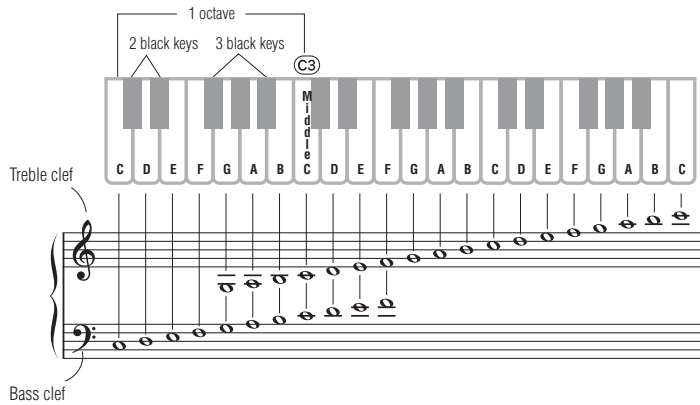

◇ Notes and Rests

Whole note			Whole note rest	
Dotted half note			Dotted half note rest	
Half note			Half note rest	
Dotted quarter note			Dotted quarter note rest	
Quarter note			Quarter note rest	
Eighth note			Eighth note rest	
Sixteenth note			Sixteenth note rest	

◇ Accidentals

- # (Sharp) Raise a semitone
- b (Flat) Lower a semitone
- ♮ (Natural) Return to normal pitch

◇ Time Signatures and Counting Time

4/4 time



2/2 time

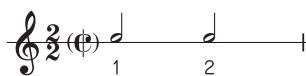

2/4 time

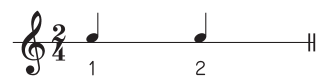

3/4 time

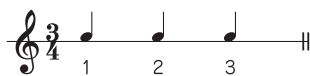

6/8 time

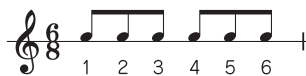

9/8 time



◇ Repeats



Play 1-2-3-2-3-4



Play 1-2-3-4-1-2-5-6



Play 1-2-3-4-5-6-1-2-3-4 D.C. (Go back to the beginning) Fine (End)

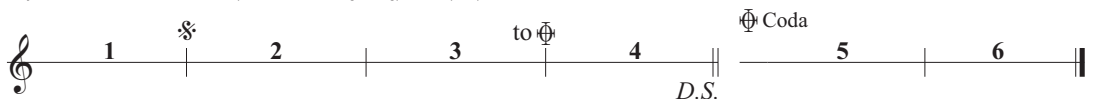

Play 1-2-3-4-2-3-5-6 D.S. (Go back to the ♯ mark) to Coda (Jump to the Coda)

Playing with a Style

This sample score is provided to demonstrate the uses and advantages of the Smart Chord function. Simply play the root notes of chords indicated in this score with your left hand as you play the melody with your right, and listen to how the sounds of the chords match the keys you play.

Home Sweet Home

Accompaniment section

The Lowest	C#	D#	F#	G#	A#	C#	D#	F#	G#	A#	C#	D#	F#	G#	A#
	D-	E-	G-	A-	B-	D-	E-	G-	A-	B-	D-	E-	G-	A-	B-
	C	D	E	F	G	A	B	C	D	E	F	G	A	B	C

Voice	001 Grand Piano
Style	116 PianoBallad
Smart Chord Key	FL1

Smart Chord Key setting

FUNCTION + G3 or A3 → FL1



**LIMITED 1-YEAR WARRANTY ON PORTABLE KEYBOARDS
(NP, PSRE, PSREW, PSRF, PSRI, PSS, SHS, EZ, DGX230, DGX530, YPG AND YPT SERIES)**

Thank you for selecting a Yamaha product. Yamaha products are designed and manufactured to provide a high level of defect-free performance. Yamaha Corporation of America ("Yamaha") is proud of the experience and craftsmanship that goes into each and every Yamaha product. Yamaha sells its products through a network of reputable, specially authorized dealers and is pleased to offer you, the Original Owner, the following Limited Warranty, which applies only to products that have been (1) directly purchased from Yamaha's authorized dealers in the fifty states of the USA and District of Columbia (the "Warranted Area") and (2) used exclusively in the Warranted Area. Yamaha suggests that you read the Limited Warranty thoroughly and invites you to contact your authorized Yamaha dealer or Yamaha Customer Service if you have any questions.

Coverage: Yamaha will, at its option, repair or replace the product covered by this warranty if it becomes defective, malfunctions or otherwise fails to conform with this warranty under normal use and service during the term of this warranty, without charge for labor or materials. Repairs may be performed using new or refurbished parts that meet or exceed Yamaha specifications for new parts. If Yamaha elects to replace the product, the replacement may be a reconditioned unit. You will be responsible for any installation or removal charges and for any initial shipping charges if the product(s) must be shipped for warranty service. However, Yamaha will pay the return shipping charges to any destination within the USA if the repairs are covered by the warranty. This warranty does not cover (a) damage, deterioration or malfunction resulting from accident, negligence, misuse, abuse, improper installation or operation or failure to follow instructions according to the Owner's Manual for this product; any shipment of the product (claims must be presented to the carrier); repair or attempted repair by anyone other than Yamaha or an authorized Yamaha Service Center; (b) any unit which has been altered or on which the serial number has been defaced, modified or removed; (c) normal wear and any periodic maintenance; (d) deterioration due to perspiration, corrosive atmosphere or other external causes such as extremes in temperature or humidity; (e) damages attributable to power line surge or related electrical abnormalities, lightning damage or acts of God; or (f) RFI/EMI (Interference/noise) caused by improper grounding or the improper use of either certified or uncertified equipment, if applicable. Any evidence of alteration, erasing or forgery of proof-of-purchase documents will cause this warranty to be void. This warranty covers only the Original Owner and is not transferable.

In Order to Obtain Warranty Service: Warranty service will only be provided for defective products within the Warranted Area. Contact your local authorized Yamaha dealer who will advise you of the procedures to be followed. If this is not successful, contact Yamaha at the address, telephone number or website shown below. Yamaha may request that you send the defective product to a local authorized Yamaha Servicer or authorize return of the defective product to Yamaha for repair. If you are uncertain as to whether a dealer has been authorized by Yamaha, please contact Yamaha's Service Department at the number shown below, or check Yamaha's website at www.yamaha.com. Product(s) shipped for service should be packed securely and must be accompanied by a detailed explanation of the problem(s) requiring service, together with the original or a machine reproduction of the bill of sale or other dated, proof-of-purchase document describing the product, as evidence of warranty coverage. Should any product submitted for warranty service be found ineligible therefore, an estimate of repair cost will be furnished and the repair will be accomplished only if requested by you and upon receipt of payment or acceptable arrangement for payment.

Limitation of Implied Warranties and Exclusion of Damages: ANY IMPLIED WARRANTIES, INCLUDING WARRANTIES OF MERCHANTABILITY AND FITNESS FOR A PARTICULAR PURPOSE SHALL BE LIMITED IN DURATION TO THE APPLICABLE PERIOD OF TIME SET FORTH ABOVE. YAMAHA SHALL NOT BE RESPONSIBLE FOR INCIDENTAL OR CONSEQUENTIAL DAMAGES OR FOR DAMAGES BASED UPON INCONVENIENCE, LOSS OF USE, DAMAGE TO ANY OTHER EQUIPMENT OR OTHER ITEMS AT THE SITE OF USE OR INTERRUPTION OF PERFORMANCES OR ANY CONSEQUENCES. YAMAHA'S LIABILITY FOR ANY DEFECTIVE PRODUCT IS LIMITED TO REPAIR OR REPLACEMENT OF THE PRODUCT, AT YAMAHA'S OPTION. SOME STATES DO NOT ALLOW LIMITATIONS ON HOW LONG AN IMPLIED WARRANTY LASTS OR THE EXCLUSION OR LIMITATION OF INCIDENTAL OR CONSEQUENTIAL DAMAGES, SO THE ABOVE LIMITATION OR EXCLUSION MAY NOT APPLY TO YOU. This Warranty gives you specific legal rights, and you may also have other rights which vary from state to state. This is the only express warranty applicable to the product specified herein; Yamaha neither assumes nor authorizes anyone to assume for it any other express warranty.

If you have any questions about service received or if you need assistance in locating an authorized Yamaha Servicer, please contact:



CUSTOMER SERVICE

Yamaha Corporation of America

6600 Orangethorpe Avenue, Buena Park, California 90620-1373

Telephone: 800-854-1569

www.yamaha.com

Do not return any product to the above address without a written Return Authorization issued by YAMAHA.

© 2019 Yamaha Corporation of America.

For details of products, please contact your nearest Yamaha representative or the authorized distributor listed below.

NORTH AMERICA

CANADA

Yamaha Canada Music Ltd.
135 Milner Avenue, Toronto, Ontario M1S 3R1,
Canada
Tel: +1-416-298-1311

U.S.A.

Yamaha Corporation of America
6600 Orangethorpe Avenue, Buena Park, CA 90620,
U.S.A.
Tel: +1-714-522-9011

CENTRAL & SOUTH AMERICA

MEXICO

Yamaha de México, S.A. de C.V.
Av. Insurgentes Sur 1647 Piso 9, Col. San José
Insurgentes, Delegación Benito Juárez, CDMX,
C.P. 03900, México
Tel: +52-55-5804-0600

BRAZIL

Yamaha Musical do Brasil Ltda.
Praça Professor José Lannes, 40-Cjs 21 e 22, Brooklin
Paulista Novo CEP 04571-100 – São Paulo – SP,
Brazil
Tel: +55-11-3704-1377

ARGENTINA

**Yamaha Music Latin America, S.A.,
Sucursal Argentina**
Olga Cossetini 1553, Piso 4 Norte,
Madero Este-C1107CEK,
Buenos Aires, Argentina
Tel: +54-11-4119-7000

PANAMA AND OTHER LATIN

AMERICAN REGIONS/ CARIBBEAN REGIONS

Yamaha Music Latin America, S.A.
Edificio Torre Davivienda, Piso: 20
Avenida Balboa, Marbella, Corregimiento de Bella
Vista, Ciudad de Panamá, Rep. de Panamá
Tel: +507-269-5311

EUROPE

THE UNITED KINGDOM/IRELAND

Yamaha Music Europe GmbH (UK)
Sherbourne Drive, Tilbrook, Milton Keynes,
MK7 8BL, U.K.
Tel: +44-1908-366700

GERMANY

Yamaha Music Europe GmbH
Siemensstrasse 22-34, 25462 Rellingen, Germany
Tel: +49-4101-303-0

SWITZERLAND/LIECHTENSTEIN

**Yamaha Music Europe GmbH, Branch
Switzerland in Thalwil**
Seestrasse 18a, 8800 Thalwil, Switzerland
Tel: +41-44-3878080

AUSTRIA/CROATIA/CZECH REPUBLIC/ HUNGARY/ROMANIA/SLOVAKIA/ SLOVENIA

Yamaha Music Europe GmbH, Branch Austria
Schleiergasse 20, 1100 Wien, Austria
Tel: +43-1-60203900

POLAND

**Yamaha Music Europe
Sp.z o.o. Oddział w Polsce**
ul. Wielicka 52, 02-657 Warszawa, Poland
Tel: +48-22-880-08-88

BULGARIA

Dinacord Bulgaria LTD.
Bul. Iskarsko Schose 7 Targowski Zentar Ewropa
1528 Sofia, Bulgaria
Tel: +359-2-978-20-25

MALTA

Olimpus Music Ltd.
Valletta Road, Mosta MST9010, Malta
Tel: +356-2133-2093

NETHERLANDS/BELGIUM/ LUXEMBOURG

Yamaha Music Europe, Branch Benelux
Clarissenhof 5b, 4133 AB Vianen, The Netherlands
Tel: +31-347-358040

FRANCE

Yamaha Music Europe
7 rue Ambroise Croizat, Zone d'activités de Pariest,
77183 Croissy-Beaubourg, France
Tel: +33-1-6461-4000

ITALY

Yamaha Music Europe GmbH, Branch Italy
Via Tinelli N.67/69 20855 Gerno di Lesmo (MB),
Italy
Tel: +39-039-9065-1

SPAIN/PORTUGAL

**Yamaha Music Europe GmbH Ibérica, Sucursal
en España**
Ctra. de la Coruña km. 17,200, 28231
Las Rozas de Madrid, Spain
Tel: +34-91-639-88-88

GREECE

Philippos Nakas S.A. The Music House
19th km. Leof. Lavriou 190 02 Peania – Attiki,
Greece
Tel: +30-210-6686260

SWEDEN

**Yamaha Music Europe GmbH Germany Filial
Scandinavia**
JA Wettergrensgata 1, 400 43 Göteborg, Sweden
Tel: +46-31-89-34-00

DENMARK

**Yamaha Music Denmark,
Filial of Yamaha Music Europe GmbH, Tyskland**
Generatorvej 8C, ST. TH., 2860 Søborg, Denmark
Tel: +45-44-92-49-00

FINLAND

F-Musiikki Oy
Antaksentie 4
FI-01510 Vantaa, Finland
Tel: +358 (0)96185111

NORWAY

**Yamaha Music Europe GmbH Germany -
Norwegian Branch**
Grini Næringspark 1, 1332 Østerås, Norway
Tel: +47-6716-7800

ICELAND

Hljóðfaerahúsid Ehf.
Sidumula 20
IS-108 Reykjavik, Iceland
Tel: +354-525-5050

CYPRUS

Nakas Music Cyprus Ltd.
Nikis Ave 2k
1086 Nicosia
Tel: +357-22-511080
Major Music Center
21 Ali Riza Ave. Ortakoy
P.O.Box 475 Lefkoşa, Cyprus
Tel: (392) 227 9213

RUSSIA

Yamaha Music (Russia) LLC.
Room 37, entrance 7, bld. 7, Kievskaya street,
Moscow, 121059, Russia
Tel: +7-495-626-5005

OTHER EUROPEAN REGIONS

Yamaha Music Europe GmbH
Siemensstrasse 22-34, 25462 Rellingen, Germany
Tel: +49-4101-303-0

AFRICA

Yamaha Music Gulf FZE
JAFZA-16, Office 512, P.O.Box 17328,
Jebel Ali FZE, Dubai, UAE
Tel: +971-4-801-1500

MIDDLE EAST

TURKEY

**Yamaha Music Europe GmbH
Merkezi Almany Türkiye Istanbul Şubesi**
Mor Sumbul Sokak Varyap Meridian Business
1. Blok No:1 113-114-115
Bati Atasehir Istanbul, Turkey
Tel: +90-216-275-7960

ISRAEL

RBX International Co., Ltd.
P.O.Box 10245, Petach-Tikva, 49002
Tel: (972) 3-925-6900

OTHER REGIONS

Yamaha Music Gulf FZE
JAFZA-16, Office 512, P.O.Box 17328,
Jebel Ali FZE, Dubai, UAE
Tel: +971-4-801-1500

ASIA

THE PEOPLE'S REPUBLIC OF CHINA

Yamaha Music & Electronics (China) Co., Ltd.
2F, Yunhedasha, 1818 Xinzha-lu, Jingan-qu,
Shanghai, China
Tel: +86-400-051-7700

HONG KONG

Tom Lee Music Co., Ltd.
11/F., Silvercord Tower 1, 30 Canton Road,
Tsimshatsui, Kowloon, Hong Kong
Tel: +852-2737-7688

INDIA

Yamaha Music India Private Limited
P-401, JMD Megapolis, Sector-48, Sohna Road,
Gurugram-122018, Haryana, India
Tel: +91-124-485-3300

INDONESIA

PT Yamaha Musik Indonesia Distributor
Yamaha Music Center Bldg. Jalan Jend. Gatot
Subroto Kav. 4, Jakarta 12930, Indonesia
Tel: +62-21-520-2577

KOREA

Yamaha Music Korea Ltd.
11F, Prudential Tower, 298, Gangnam-daero,
Gangnam-gu, Seoul, 06253, Korea
Tel: +82-2-3467-3300

MALAYSIA

Yamaha Music (Malaysia) Sdn. Bhd.
No.8, Jalan Perbandaran, Kelana Jaya, 47301
Petaling Jaya, Selangor, Malaysia
Tel: +60-3-7803900

SINGAPORE

Yamaha Music (Asia) Private Limited
Block 202 Hougang Street 21, #02-00,
Singapore 530202, Singapore
Tel: +65-6740-9200

TAIWAN

Yamaha Music & Electronics Taiwan Co., Ltd.
2F, No.1, Yuanfong Rd., Banqiao Dist.,
New Taipei City 22063, Taiwan (R.O.C.)
Tel: +886-2-7741-8888

THAILAND

Siam Music Yamaha Co., Ltd.
3, 4, 15, 16th Fl., Siam Motors Building,
891/1 Rama 1 Road, Wangmai,
Pathumwan, Bangkok 10330, Thailand
Tel: +66-2215-2622

VIETNAM

Yamaha Music Vietnam Company Limited
15th Floor, Nam A Bank Tower, 201-203 Cach
Mang Thang Tam St., Ward 4, Dist.3,
Ho Chi Minh City, Vietnam
Tel: +84-28-3818-1122

OTHER ASIAN REGIONS

[https://asia-latinamerica-mea.yamaha.com/
index.html](https://asia-latinamerica-mea.yamaha.com/index.html)

OCEANIA

AUSTRALIA

Yamaha Music Australia Pty. Ltd.
Level 1, 80 Market Street, South Melbourne,
VIC 3205 Australia
Tel: +61-3-9693-5111

NEW ZEALAND

Music Works LTD
P.O. BOX 6246 Wellesley, Auckland 4680,
New Zealand
Tel: +64-9-634-0099

REGIONS AND TRUST

TERRITORIES IN PACIFIC OCEAN

[https://asia-latinamerica-mea.yamaha.com/
index.html](https://asia-latinamerica-mea.yamaha.com/index.html)

Head Office/Manufacturer: Yamaha Corporation 10-1, Nakazawa-cho, Naka-ku, Hamamatsu, 430-8650, Japan

Importer (European Union): Yamaha Music Europe GmbH Siemensstrasse 22-34, 25462 Rellingen, Germany

Importer (United Kingdom): Yamaha Music Europe GmbH (UK) Sherbourne Drive, Tilbrook, Milton Keynes, MK7 8BL, United Kingdom

DMI30

Yamaha Global Site
<https://www.yamaha.com/>

Yamaha Downloads
<https://download.yamaha.com/>

Manual Development Group
© 2019 Yamaha Corporation
Published 06/2021 POIN*.***B0

VAV7160