

DIGITAL MIXING STUDIO **n8/n12**

Owner's Manual
Bedienungsanleitung
Mode d'emploi
Manual de instrucciones



English

Deutsch

Français

Español

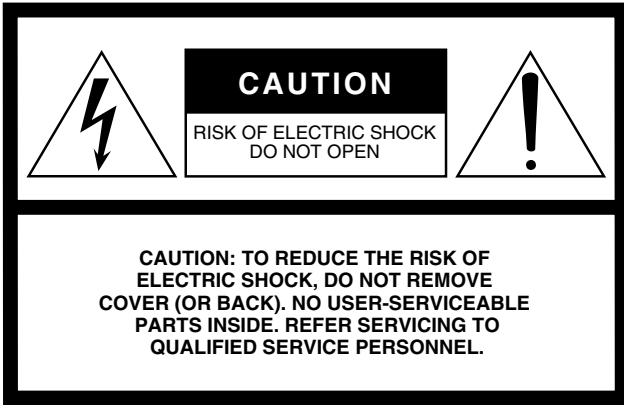

The above warning is located on the rear of the unit.

Explanation of Graphical Symbols

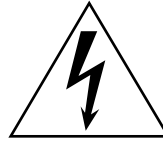

The lightning flash with arrowhead symbol within an equilateral triangle is intended to alert the user to the presence of uninsulated “dangerous voltage” within the product’s enclosure that may be of sufficient magnitude to constitute a risk of electric shock to persons.



The exclamation point within an equilateral triangle is intended to alert the user to the presence of important operating and maintenance (servicing) instructions in the literature accompanying the product.

IMPORTANT SAFETY INSTRUCTIONS

- 1 Read these instructions.
- 2 Keep these instructions.
- 3 Heed all warnings.
- 4 Follow all instructions.
- 5 Do not use this apparatus near water.
- 6 Clean only with dry cloth.
- 7 Do not block any ventilation openings. Install in accordance with the manufacturer’s instructions.
- 8 Do not install near any heat sources such as radiators, heat registers, stoves, or other apparatus (including amplifiers) that produce heat.
- 9 Do not defeat the safety purpose of the polarized or grounding-type plug. A polarized plug has two blades with one wider than the other. A grounding type plug has two blades and a third grounding prong. The wide blade or the third prong are provided for your safety. If the provided plug does not fit into your outlet, consult an electrician for replacement of the obsolete outlet.
- 10 Protect the power cord from being walked on or pinched particularly at plugs, convenience receptacles, and the point where they exit from the apparatus.
- 11 Only use attachments/accessories specified by the manufacturer.
- 12 Use only with the cart, stand, tripod, bracket, or table specified by the manufacturer, or sold with the apparatus. When a cart is used, use caution when moving the cart/apparatus combination to avoid injury from tip-over.
- 13 Unplug this apparatus during lightning storms or when unused for long periods of time.
- 14 Refer all servicing to qualified service personnel. Servicing is required when the apparatus has been damaged in any way, such as power-supply cord or plug is damaged, liquid has been spilled or objects have fallen into the apparatus, the apparatus has been exposed to rain or moisture, does not operate normally, or has been dropped.



WARNING

TO REDUCE THE RISK OF FIRE OR ELECTRIC SHOCK, DO NOT EXPOSE THIS APPARATUS TO RAIN OR MOISTURE.

FCC INFORMATION (U.S.A.)

1. IMPORTANT NOTICE: DO NOT MODIFY THIS UNIT!

This product, when installed as indicated in the instructions contained in this manual, meets FCC requirements. Modifications not expressly approved by Yamaha may void your authority, granted by the FCC, to use the product.

2. IMPORTANT:

When connecting this product to accessories and/or another product use only high quality shielded cables. Cable/s supplied with this product MUST be used. Follow all installation instructions. Failure to follow instructions could void your FCC authorization to use this product in the USA.

3. NOTE:

This product has been tested and found to comply with the requirements listed in FCC Regulations, Part 15 for Class "B" digital devices. Compliance with these requirements provides a reasonable level of assurance that your use of this product in a residential environment will not result in harmful interference with other electronic devices. This equipment generates/uses radio frequencies and, if not installed and used according to the instructions found in the users manual, may cause interference harmful to the operation of other electronic devices. Compliance with FCC regulations does

not guarantee that interference will not occur in all installations. If this product is found to be the source of interference, which can be determined by turning the unit "OFF" and "ON", please try to eliminate the problem by using one of the following measures:

Relocate either this product or the device that is being affected by the interference.

Utilize power outlets that are on different branch (circuit breaker or fuse) circuits or install AC line filter/s.

In the case of radio or TV interference, relocate/reorient the antenna. If the antenna lead-in is 300 ohm ribbon lead, change the lead-in to co-axial type cable.

If these corrective measures do not produce satisfactory results, please contact the local retailer authorized to distribute this type of product. If you can not locate the appropriate retailer, please contact Yamaha Corporation of America, Electronic Service Division, 6600 Orangethorpe Ave, Buena Park, CA90620

The above statements apply ONLY to those products distributed by Yamaha Corporation of America or its subsidiaries.

* This applies only to products distributed by YAMAHA CORPORATION OF AMERICA.

(class B)

OBSERVERA!

Apparaten kopplas inte ur växelströmskällan (nätet) så länge som den är ansluten till vägguttaget, även om själva apparaten har stängts av.

ADVARSEL: Netspændingen til dette apparat er IKKE afbrudt, så længe netledningen sidder i en stikkontakt, som er tændt — også selvom der er slukket på apparatets afbryder.

VAROITUS: Laitteen toisiopiiriin kytketty käyttökytin ei irroita koko laitetta verkosta.

(standby)

The serial number of this product may be found on the rear of the unit. You should note this serial number in the space provided below and retain this manual as a permanent record of your purchase to aid identification in the event of theft.

Model No.

Serial No.

(rear)

IMPORTANT

Please record the serial number of this unit in the space below.
Model:

Serial No.:

The serial number is located on the bottom or rear of the unit. Retain this Owner's Manual in a safe place for future reference.

* This applies only to products distributed by YAMAHA CORPORATION OF AMERICA

(Ser. No)

COMPLIANCE INFORMATION STATEMENT (DECLARATION OF CONFORMITY PROCEDURE)

Responsible Party : Yamaha Corporation of America

Address : 6600 Orangethorpe Ave., Buena Park, Calif. 90620

Telephone : 714-522-9011

Type of Equipment : Digital Mixing Studio

Model Name : n8/n12

This device complies with Part 15 of the FCC Rules.

Operation is subject to the following conditions:

- 1) this device may not cause harmful interference, and
- 2) this device must accept any interference received including interference that may cause undesired operation.

See user manual instructions if interference to radio reception is suspected.

* This applies only to products distributed by YAMAHA CORPORATION OF AMERICA.

(FCC DoC)

IMPORTANT NOTICE FOR THE UNITED KINGDOM

Connecting the Plug and Cord

IMPORTANT. The wires in this mains lead are coloured in accordance with the following code:

BLUE : NEUTRAL
BROWN : LIVE

As the colours of the wires in the mains lead of this apparatus may not correspond with the coloured markings identifying the terminals in your plug proceed as follows:

The wire which is coloured BLUE must be connected to the terminal which is marked with the letter N or coloured BLACK.

The wire which is coloured BROWN must be connected to the terminal which is marked with the letter L or coloured RED.

Making sure that neither core is connected to the earth terminal of the three pin plug.

• This applies only to products distributed by Yamaha-Kemble Music (U.K.) Ltd. (2 wires)

Table of Contents

Welcome	5	Using the n8/n12 with Cubase 5 series	33
Features	5	What you can do using the n8/n12 with Cubase ...	33
Included items (please check)	5	Computer setup for the Link function	34
Turning On and Off the Power to the Mixer	8	Using the Link Function	36
Before Turning On the Power to the Mixer	8	Remotely controlling the Cubase transport section and audio tracks	36
Turning the Power On and Off	8	Remotely adjusting the click sound (metronome)	36
Recording Basics	9	Selecting the Work mode	36
Techie Words? Don't Be Afraid.	9	Let's start our recording session!	39
Signals — Level and Decibel	9	Mixing signals on the n8/n12, then recording	39
Balanced or Unbalanced?	9	Recording n8/n12 input channel signals directly to Cubase	41
How balanced lines work	9	Mixing recorded tracks	43
How unbalanced lines work	10	Mixing audio tracks	43
Connector Variations	10	Mixing down	45
Phone connectors	10	Monitoring in a Surround Sound Environment (n12 only)	46
RCA pin connectors	10	Connecting surround speakers	46
Inside Your Mixer	11	Placement of the surround speakers	46
Basic Structure	11	Setting up surround monitoring	47
Monitor mix for musicians, external effects	12	Replacing the Sweet Spot Data ...	48
Front and Rear Panels	13	Using the n8/n12 with Software Other Than Cubase	49
Channel Control section	13	Using the n8/n12 with a DAW other than Cubase .	49
Master Control section	16	Audio Driver Setup	49
Meter section	17	MIDI Driver Setup	49
Control Room section	18	Using the n8/n12 along with a multimedia application	51
DAW Remote Control section	19	Troubleshooting	53
Rear I/O section	20	While using the mixer	53
Setting Up the Mixer	22	While using the mixer with a computer	53
Setup Procedure	22	Error Messages	55
n12 Setup Example (Home recording)	22	Index	56
n8 Setup Example (Home recording)	23	Appendix	57
Installing Monitor Speakers	23	Specifications	57
A Hands-On Guide to the n8/n12 ...	24	Bus connections of n8/n12 and DAW	60
Let's Hear It!	24	Dimensional Diagrams	63
Connecting sound sources and monitor devices	24	Block Diagram	64
Adjusting the gain	24	MIDI Implementation Chart	65
Setting up the monitoring environment	25		
Adjusting the volume level	26		
Making Great Mixes	28		
Manipulating compression	28		
Mastery of EQ	29		
Panning and balancing	30		
Mixing into stereo	30		
Applying reverb	31		
Soloing a channel	32		

Welcome

Thank you for purchasing the Yamaha n8/n12 Digital Mixing Studio. The n8/n12 is a comprehensive music production system that packages a digital mixer featuring easy yet full-fledged recording/mixdown operations with the cutting-edge DAW software Cubase AI. Connecting a computer to the mixer's IEEE 1394 port enables you to configure an ideal recording environment. Please read this Owner's Manual before you start using the n8/n12 so that you can take full advantage of the mixer's superlative features and enjoy trouble-free operation for years to come. Also, keep this book in a safe place for future reference.

Features

Ease of operation

Analog-like mixing interface ensures intuitive operation.

High-quality sound

Based on an examination of existing head amp circuits, a new head amp circuit has been developed to provide higher quality and superior musical characteristics.

Mixer functions

The mixer can handle up to 16 channel inputs (n12) or 12 channel inputs (n8), mixing them to stereo outputs. Each monaural input jack features an XLR jack with a phantom power supply, which enables you to connect a wide range of instruments and devices, from condenser microphones to synthesizers and other line-level instruments. Input channel 8 (n12) and Input channel 4 (n8) support Hi-Z input for direct connection of an electric guitar or bass.

Computer connection via a single IEEE 1394 cable

Connect a computer with an IEEE 1394 port to the n8/n12 using an IEEE 1394 cable to transfer audio and MIDI signals between the mixer and Steinberg Cubase or other DAW.

* In order to monitor in a surround environment, you will need a surround-capable application such as Cubase 5. The included Cubase AI does not support surround.

Link with Cubase

Install Cubase AI on the computer, and the n8/n12 will link to Cubase and operate together seamlessly. For example, you can record the n8/n12 input signals to Cubase as is, or mix Cubase audio tracks on the n8/n12. You can also turn on and off the monitor for the VST effects or control the transport section and tracks remotely from the n8/n12. In addition, Purchase the separately-available Cubase 5 and use it with the n8/n12 to enjoy advanced functionality such as surround.

Control Room monitoring function

The n8/n12 features a monitoring function dedicated to the Control Room (Control Room Monitor function). You can connect one (n8) or three (n12) monitoring speakers to the mixer. If a computer is connected to the n12, you can monitor the sound from Cubase or another DAW in a surround sound environment.

Newly developed compressor

The n8/n12 includes a newly developed compressor that adopts Sweet Spot Morphing technology. The mixer provides various compressor presets that represent the distillation of extensive professional engineering experience, letting you quickly and easily bring your sound to a professional standard.

Three-band EQ on each channel

Each input channel features a full 3-band (high/mid/low) equalizer, providing easy sound shaping to suit your preferences.

Digital reverb at your service

A built-in digital reverb can be assigned to all input channels. If a computer is connected to the mixer, you can also apply digital reverberation to output from Cubase or another DAW, as well as to microphone and other instrumental sounds.

Included items (please check)

Power adaptor (n12= PA-30, n8=PA-20)*

* May not be included depending on your particular area. Please check with your Yamaha dealer.

Owner's Manual

IEEE 1394 cable

TOOLS for n Version2/Cubase AI installation guide

TOOLS for n Version2 CD-ROM

Cubase AI DVD-ROM



Please read the software license agreement before you unseal the included discs. The software license agreement is given at the end of the TOOLS for n Version2/Cubase AI installation guide.

PRECAUTIONS

PLEASE READ CAREFULLY BEFORE PROCEEDING

* Please keep this manual in a safe place for future reference.



WARNING

Always follow the basic precautions listed below to avoid the possibility of serious injury or even death from electrical shock, short-circuiting, damages, fire or other hazards. These precautions include, but are not limited to, the following:

Power supply/Power cord

- Only use the voltage specified as correct for the device. The required voltage is printed on the name plate of the device.
- Use only the included AC power adaptor (*PA-30 for the n12, PA-20 for the n8 or an equivalent recommended by Yamaha).
- Do not place the power cord near heat sources such as heaters or radiators, and do not excessively bend or otherwise damage the cord, place heavy objects on it, or place it in a position where anyone could walk on, trip over, or roll anything over it.

Do not open

- Do not open the device or attempt to disassemble the internal parts or modify them in any way. The device contains no user-serviceable parts. If it should appear to be malfunctioning, discontinue use immediately and have it inspected by qualified Yamaha service personnel.

Water warning

- Do not expose the device to rain, use it near water or in damp or wet conditions, or place containers on it containing liquids which might spill into any openings.
If any liquid such as water seeps into the device, turn off the power immediately and unplug the power cord from the AC outlet. Then have the device inspected by qualified Yamaha service personnel.
- Never insert or remove an electric plug with wet hands.

If you notice any abnormality

- If the power cord or plug becomes frayed or damaged, or if there is a sudden loss of sound during use of the device, or if any unusual smells or smoke should appear to be caused by it, immediately turn off the power switch, disconnect the electric plug from the outlet, and have the device inspected by qualified Yamaha service personnel.
- If this device or the AC power adaptor should be dropped or damaged, immediately turn off the power switch, disconnect the electric plug from the outlet, and have the device inspected by qualified Yamaha service personnel.



CAUTION

Always follow the basic precautions listed below to avoid the possibility of physical injury to you or others, or damage to the device or other property. These precautions include, but are not limited to, the following:

Power supply/Power cord

- Remove the electric plug from the outlet when the device is not to be used for extended periods of time, or during electrical storms.
- When removing the electric plug from the device or an outlet, always hold the plug itself and not the cord. Pulling by the cord can damage it.
- To avoid generating unwanted noise, make sure there is adequate distance between the AC power adaptor and the device.
- Do not cover or wrap the AC power adaptor with a cloth or blanket.

Location

- Before moving the device, remove all connected cables.
- When setting up the device, make sure that the AC outlet you are using is easily accessible. If some trouble or malfunction occurs, immediately turn off the power switch and disconnect the plug from the outlet. Even when the power switch is turned off, electricity is still flowing to the product at the minimum level. When you are not using the product for a long time, make sure to unplug the power cord from the wall AC outlet.

- Avoid setting all equalizer controls and faders to their maximum. Depending on the condition of the connected devices, doing so may cause feedback and may damage the speakers.
- Do not expose the device to excessive dust or vibrations, or extreme cold or heat (such as in direct sunlight, near a heater, or in a car during the day) to prevent the possibility of panel disfiguration or damage to the internal components.
- Do not place the device in an unstable position where it might accidentally fall over.
- Do not block the vents. This device has ventilation holes at the top/bottom to prevent the internal temperature from becoming too high. In particular, do not place the device on its side or upside down. Inadequate ventilation can result in overheating, possibly causing damage to the device(s), or even fire.
- Do not use the device in the vicinity of a TV, radio, stereo equipment, mobile phone, or other electric devices. Doing so may result in noise, both in the device itself and in the TV or radio next to it.

Connections

- Before connecting the device to other devices, turn off the power for all devices. Before turning the power on or off for all devices, set all volume levels to minimum.

Maintenance

- Remove the power plug from the AC outlet when cleaning the device.

Handling caution

- When turning on the AC power in your audio system, always turn on the power amplifier LAST, to avoid speaker damage. When turning the power off, the power amplifier should be turned off FIRST for the same reason.
- Do not insert your fingers or hands in any gaps or openings on the device (vents, ports, etc.).
- Avoid inserting or dropping foreign objects (paper, plastic, metal, etc.) into any gaps or openings on the device (vents, ports, etc.) If this happens, turn off the power immediately and unplug the power cord from the AC outlet. Then have the device inspected by qualified Yamaha service personnel.
- Do not apply oil, grease, or contact cleaner to the faders. Doing so may cause problems with electrical contact or fader motion.
- Do not use the device or headphones for a long period of time at a high or uncomfortable volume level, since this can cause permanent hearing loss. If you experience any hearing loss or ringing in the ears, consult a physician.
- Do not rest your weight on the device or place heavy objects on it, and avoid use excessive force on the buttons, switches or connectors.

XLR-type connectors are wired as follows (IEC60268 standard): pin 1: ground, pin 2: hot (+), and pin 3: cold (-).
Insert TRS phone jacks are wired as follows: sleeve: ground, tip: send, and ring: return.

Yamaha cannot be held responsible for damage caused by improper use or modifications to the device, or data that is lost or destroyed.

Always turn the power off when the device is not in use.

Even when the power switch is in the "STANDBY" position, electricity is still flowing to the device at the minimum level. When you are not using the device for a long time, make sure you unplug the power cord from the wall AC outlet.

The performance of components with moving contacts, such as switches, volume controls, and connectors, deteriorates over time. Consult qualified Yamaha service personnel about replacing defective components.

The illustrations and LCD screens as shown in this owner's manual are for instructional purposes only, and may appear somewhat different from those on your instrument.

This product incorporates and bundles computer programs and contents in which Yamaha owns copyrights or with respect to which it has license to use others' copyrights. Such copyrighted materials include, without limitation, all computer software, music data, etc. Any unauthorized use of such programs and contents outside of personal use is not permitted under relevant laws. Any violation of copyright has legal consequences. **DON'T MAKE, DISTRIBUTE OR USE ILLEGAL COPIES.**

Copying of the commercially available musical data including but not limited to MIDI data and/or audio data is strictly prohibited except for your personal use.

- Windows is the registered trademarks of Microsoft(R) Corporation.
- Apple, Mac and Macintosh are trademarks of Apple Inc., registered in the U.S. and other countries.
- FireWire and the FireWire symbol are trademarks of Apple, Inc., registered in the U.S. and other countries. The FireWire logo is a trademark of Apple, Inc.
- Steinberg and Cubase are the registered trademarks of Steinberg Media Technologies GmbH.
- The company names and product names in this Owner's Manual are the trademarks or registered trademarks of their respective companies.



Turning On and Off the Power to the Mixer

Before Turning On the Power to the Mixer

1. Make sure that the mixer's power switch is in the **STANDBY** position.

Warning

Use only the included power adaptor (*PA-30 for the n12, PA-20 for the n8 or an equivalent recommended by Yamaha). Use of a different adaptor may result in equipment damage, overheating, or fire. In such cases, the product warranty will be void immediately even within the effective warranty period.

2. Connect the power adaptor to the **AC INPUT** connector (1) on the rear panel of the mixer, then turn the fastening ring clockwise (2) to secure the connection.

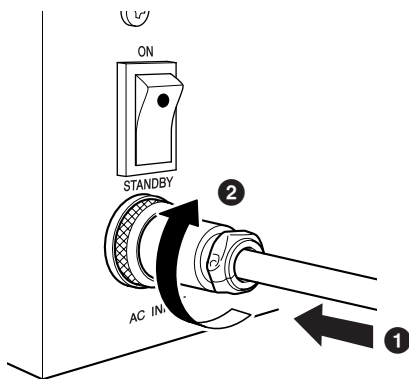

3. Connect the power adaptor to a standard household power outlet securely.

Caution

- Be sure to unplug the adaptor from the outlet when you are not using the mixer, or when lightning storms are expected in your area.
- Make sure that there is adequate distance between the power adaptor and the mixer. Otherwise, noise may be generated.

Turning the Power On and Off

1. To turn the power on, press the mixer's power switch to the **ON** position.
2. To turn the power off, press the power switch to the **STANDBY** position.

Caution

Note that a small amount of current continues to flow while the switch is in the **STANDBY** position. If you do not plan to use the mixer for an extended period of time, please be sure to unplug the adaptor from the wall outlet.

NOTE

To prevent sudden loud sounds from being produced from your speakers, power-on your equipment starting at the audio source (instrument, mic, CD player, etc.) and working downstream. **Example:** Instruments, mics, CD players, and other peripheral devices → n8/n12 → Powered speakers (power amps)
When turning the power off, reverse the above sequence.

Recording Basics

Techie Words? Don't Be Afraid.

Signals — Level and Decibel

Assume the softest sound a human being can hear is at a level of "1," and the loudest sound a human being can endure hearing is at a level of "1,000,000." The difference expressed in these numbers is huge, and you have to use too many digits to express the level. This is very inconvenient. So, we use a term or unit called "decibel (dB)," defining the normal level difference between the softest and loudest sounds detectable by human hearing to be 120 dB. A decibel is a relative value based on a reference level of 0 dB. Audio devices usually treat audio as electrical signals. There are various types of decibel measurements: dBu, dBV, dBm, etc., but the most popular one is dBu, which is based on 0.775V as the reference level (0 dBu). The output level of a microphone is very low — about several millivolts (–60 dBu — –30 dBu). On the other hand, the maximum output of a mixer can be 12 V (+24 dBu).

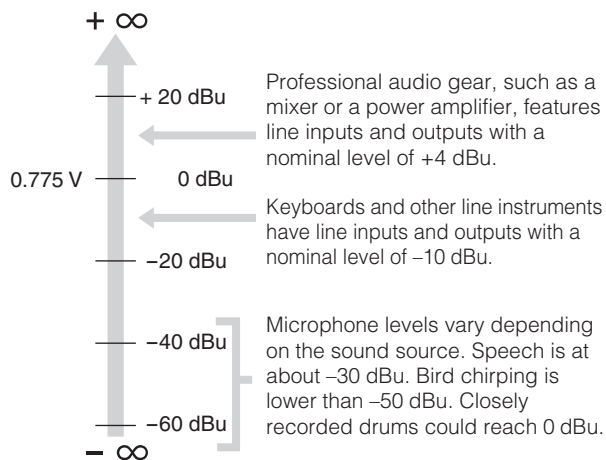

To create clear sounds, a signal should be input to a mixer at an appropriate level. When you connect audio devices to your mixer, be sure to match the nominal input of an instrument to the output level of the mixer, then adjust the input level with the mixer's gain control.

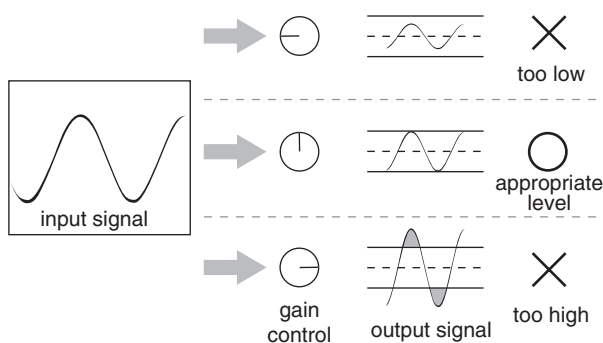

Balanced or Unbalanced?

In most cases, shielded cables are used to transfer signals between audio devices. Shielded cables are divided into two types: balanced and unbalanced. Balanced lines are very good at rejecting noise, and they are the best choice for long cable runs or for transferring very weak signals. Unbalanced cables are usually used for line-level signals.

Microphone: Use balanced lines.
Short line-level runs: Unbalanced lines are fine.
Long line-level runs: Use balanced lines.

We are constantly surrounded by random electromagnetic radiation (noise), such as radio and TV signals as well as spurious electromagnetic noise generated by power lines, motors, electric appliances, computers, and other sources. The longer the wire, the more noise it is likely to pick up. To avoid noise, use the shortest cable possible.

Anatomy of a shielded cable

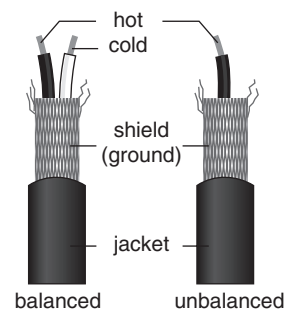

As shown in the illustration above, a shielded cable consists of one hot (and cold conductor) wrapped in a metal net (shield, or ground conductor). The ground functions as a barrier against noise, protecting the signal from noise that may be induced in the line.

How balanced lines work

A cable that features an XLR plug on each end is a balanced line. It consists of hot (+), cold (–), and ground conductors.

A device transmits an original hot (+) signal through the hot conductor and the same, but inverted, signal through the cool (–) conductor to the destination. The receiving device inverts the inverted signal back to normal and combines it with the original hot signal. Any noise induced in the line will be exactly the same in both conductors, and thus in phase. The trick is that the phase of one signal (through the cool (–) conductor) is reversed at the receiving end of the line so that the desired audio signals become in-phase, and the induced noise suddenly finds itself out of phase. The out-of-phase noise signal is effectively canceled while the audio signal is left intact.

This is why balanced lines excel at rejecting noise.

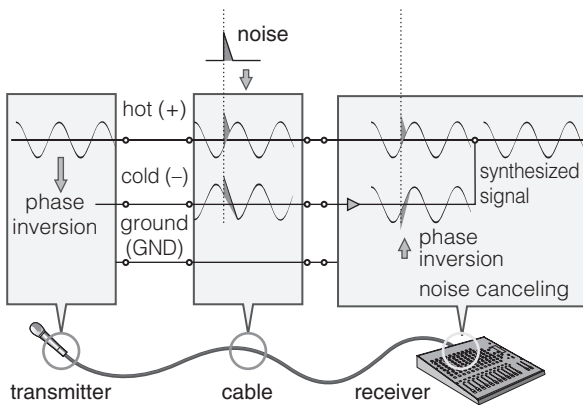

How unbalanced lines work

Unbalanced connectors and cables are less expensive than balanced cables. If the level of signals to be transmitted is very high and/or the signal is not susceptible to noise, or all connections are very short, you can use unbalanced lines.

Monaural phone jacks and RCA pin jacks (which are often used for consumer AV gear) are always unbalanced. On an unbalanced line, signals travel through a hot (+) conductor and a ground (GND) conductor (which is a combination of cold and ground conductors). Therefore, an unbalanced line does not feature noise canceling (unlike a balanced cable). However, the output signal level through unbalanced jacks is usually high enough that using unbalanced lines is just fine. You can also convert unbalanced signals into balanced signals using a DI (*).

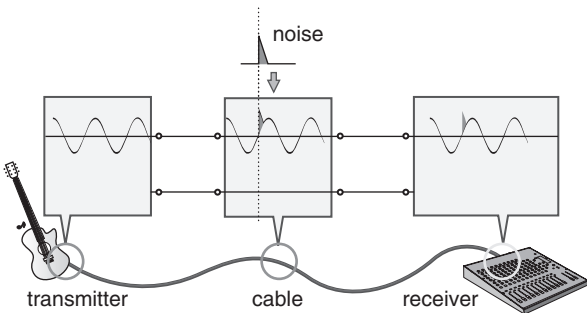

(*) A DI is a direct injection box that converts unbalanced signals into balanced signals. For example, if you connect an electric guitar to a mixer directly, the sound may be thin or noise may be induced. In this case, you can connect a DI between the instrument and the mixer to convert the signal into a balanced one and avoid a thin, noisy sound.

Connector Variations

Audio devices feature various types of connectors. Questions you are likely to encounter when setting up a system for the first time might include “Why all these different types of connectors on the back of my mixer?” and “What is the difference between various types of connectors?”

Let’s start by taking a look at the most common types of connectors.

XLR-type connectors



An XLR-type connector, which supports balanced lines, is sturdy and less susceptible to deformation. The plug features a lock mechanism, so even if you pull the cable, it will not be disconnected. It is often used in professional environments that demand a high level of reliability.

When you connect an XLR cable, the ground conductor on the XLR plug and XLR jack comes in contact first. Therefore, unlike with an RCA pin cable or phone cable, you can avoid pop noises when connecting an XLR cable. Usually, male plugs will output and female plugs will input.

Phone connectors

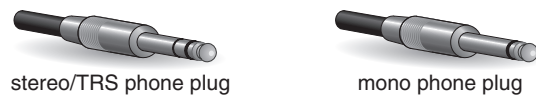

The name “phone” arose simply because this configuration was first used in telephone switchboards. Phone jacks can be stereo or monaural. A stereo phone jack is also referred to as a “TRS” phone jack, and is set up to handle stereo signals, such as for headphones, and insert I/O signals. A stereo phone jack can also handle balanced signals. A monaural phone jack is unbalanced, and can be used to connect an electric guitar or other instruments, to an amplifier.

RCA pin connectors

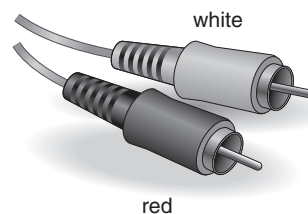

This type of unbalanced pin jack has been widely used on home audio/video equipment for many years. The plugs are color coded according to the signals they carry. A white plug is used for the left audio channel, and a red plug is used for the right audio channel.

English

Inside Your Mixer

Basic Structure

The purpose of configuring an audio system around a mixer is to collect signals from all channels and mix to achieve a good balance. Here is a greatly simplified block diagram of a mixer to help you understand the signal path.

Simplified mixer block diagram

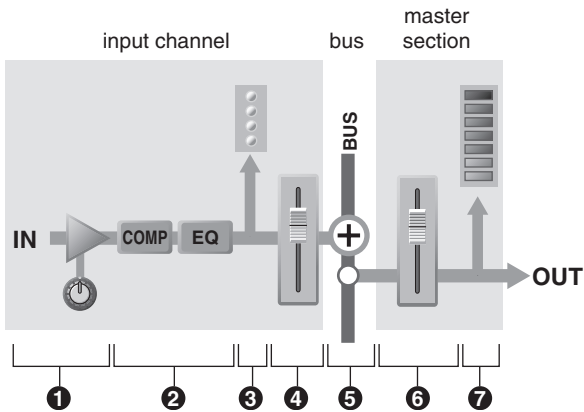

Input channel

1 Head amp

The very first stage in any mixer through which the input signal flows. The head amp features a gain control that enables you to adjust the mixer's input sensitivity to match the level of the source. You can amplify small signals, and attenuate large signals.

2 Compressor/Equalizer

This stage enables you to process the input signal. A compressor attenuates the peak level of the input signal, and raises the overall signal level at the same time, to lessen the level difference and raise the sound pressure.

An equalizer adjusts the tone by boosting (amplifying) or cutting (attenuating) certain frequency ranges. You can use an equalizer to change the tone to suit the acoustic environment of a particular room, or to create a new sound. An equalizer could be a high pass filter that cuts the sound below a specified frequency. Some mixers feature compressors and/or equalizers, and some do not.

3 Level meter (input channel)

If the signal level is too high for the head amp or compressor/equalizer to handle, the sound will clip and be distorted. An input channel level meter enables you to monitor this signal level. Some mixers feature a channel peak LED that indicates only the peak level. If the input signal is overloaded, adjust the head amp gain control.

Most mixers have multiple level meters (including the indicators). It is important to know the mixer stage for which the meters are indicating signal levels.

4 Channel fader

A channel fader enables you to adjust the level of the corresponding input channel signal that is going to be routed to the buses (excluding a pre-fader signal).

This control is most often used during mixing.

Bus

5 Bus

Input channel signals are routed to buses, mixed together there, then output in stereo (master).

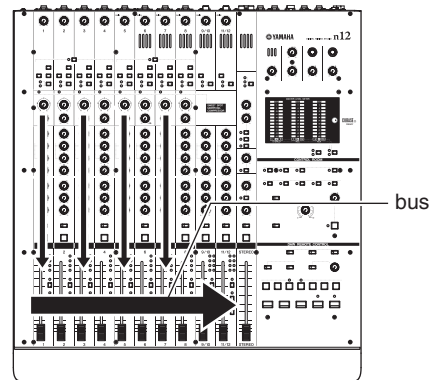

Buses are categorized into a few types based on their purpose: stereo bus for stereo mix, AUX bus for AUX send, etc. Using the appropriate buses is one of the keys to basic mixing.

The n8/n12 features the following buses:

- STEREO bus (L/R)
- AUX bus (L/R)
- REC bus (L/R)
- REVERB bus (L/R)
- SOLO bus (L/R)

Master section

6 Stereo (master) fader

The master section enables you to adjust the level of signals routed from buses.

Use a stereo master fader to adjust the level of the mixer's main output from the stereo buses.

Depending on the design of the mixer, a fader is provided for each bus so that you can adjust the level of each bus output.

7 Level meter (master)

This meter indicates the signal level in the master section, which is the mixer's final output level.

Monitor mix for musicians, external effects

One important mixer function is to send out signals for signal processing via an external effect unit or to be monitored by the musicians. For these purposes, mixers feature AUX bus and Insert I/O.

■ AUX buses for monitor sends and overall effects

AUX (Auxiliary) buses are very convenient buses that can be used for various purposes, such as: a) to create a monitor mix that is separate from the main mix and sent to the players for monitoring, and b) to process the signal via an external effect unit and then bring it back into the mix.

When you are using the AUX buses, you need to consider whether you want a “pre-fader” signal (a signal taken from a point before the channel fader) or a “post-fader” signal (a signal taken from a point after the channel fader) to be sent to the AUX buses.

On the n8/n12, a pre-fader signal is sent to the AUX bus. Thus the bus signal is not affected by the channel fader.

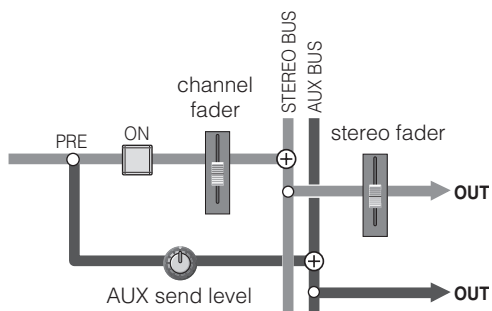

• Using AUX buses to create a monitor mix for players

Players prefer a pre-fader signal that maintains a proper level balance. Since the pre-fader signal is sent to the AUX bus on the n8/n12, even if you raise the input channel fader for guitar during the guitar solo, the fader operation does not affect the AUX bus output, which remains independent of the main mix.

If a post-fader signal is routed to the AUX buses for monitoring, the fader operation will affect the balance of the monitor mix. This is something that you and the players would probably like to avoid.

• Using AUX buses to process the signal via an external effect unit

If you are using an AUX bus to send a pre-fader signal to an external effect unit, you can adjust the level of the input channel signal and the amount of effect separately.

For example, if you operate the fader for the input channel signal that is sent to the effect unit, the balance between the dry signal (unprocessed) and the wet signal (processed by the effect unit) will change. To maintain the same balance between the dry and wet signals, you must adjust the AUX send level whenever you adjust the channel fader.

■ Built-in digital reverb

The n8/n12 features a REVERB bus that is dedicated to the built-in digital reverb. This is almost identical to the AUX bus, and can be used to send signals to the built-in digital reverb.

The only difference from the AUX bus is that a post-fader signal is routed to the REVERB bus. Therefore, the send level is affected by the channel fader, so the effect level always remains in proportion to the channel signal when you adjust the channel fader.

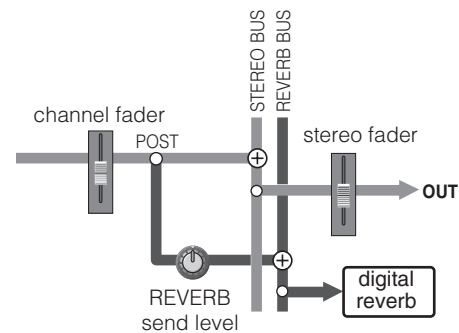

■ Insert I/O for processing individual channel signals

Insert I/O jacks function in a manner similar to the AUX buses: they provide a send and a return for signal processing via an external effect unit. However, unlike AUX buses that “collect multiple channel signals, then send them together to an effect unit,” insert I/O jacks are used to “send an individual channel signal to an external effect unit, then return it to the mixer.”

A channel signal that is routed to the insert out jack has already been amplified or attenuated to an appropriate level via the gain control. Connect a compressor, limiter, equalizer or other effect unit that can control the overall signal to the insert I/O jacks.

You can also connect a reverb or similar effect unit to process only a single channel signal.

When you connect an effect unit to the insert I/O jacks, the channel signal will be routed to the external effect unit via the insert out jack. The signal will be processed by the effect unit, then returned to the mixer via the insert in jack. It then resumes its normal path.

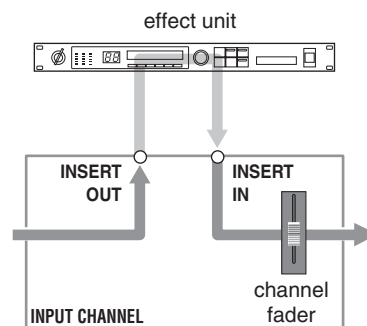

Front and Rear Panels

Channel Control section

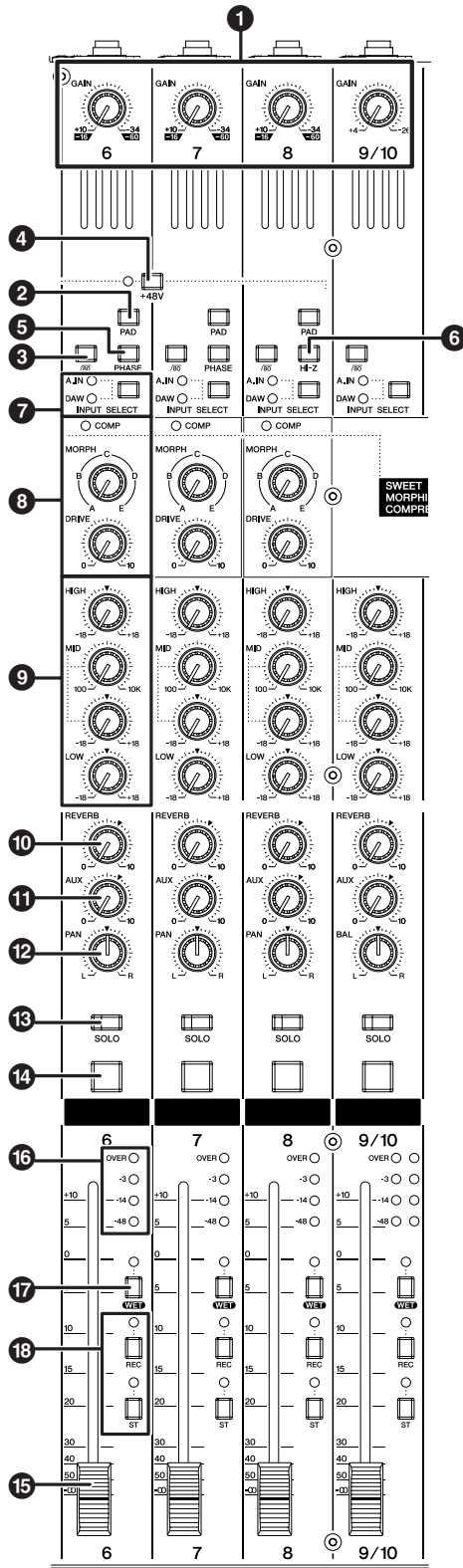

n12

1 [GAIN] control

This control adjusts the input signal level from the input jacks (sensitivity). The adjustable range on each monaural channel varies depending on the on/off status of the [PAD] switch (2).

Monaural input channel

[PAD] switch is on (<input checked="" type="checkbox"/>).	The level can be adjusted between -34 dB and +10 dB.
[PAD] switch is off (<input type="checkbox"/>).	The level can be adjusted between -60 dB and -16 dB.

Stereo input channel

The level can be adjusted between -26 dB and +4 dB.

To achieve a quality sound with a good S/N ratio and a wide dynamic range, set this control as high as possible without allowing the OVER LED (see page 15) to light.

2 [PAD] switch

This switch turns each channel pad on and off. When it is turned on (), the input signal from the input jacks is attenuated by 26 dB. Turn the switch off () when you connect a microphone or other device with a low input level to the corresponding monaural channel. Turn it on () when you connect a synthesizer or other line-level instruments.

3 $\sqrt{80}$ switch (high pass filter)

This switch toggles the high pass filter on or off. When the switch is turned on (), the high pass filter cuts frequencies below 80 Hz of the signal from the input jacks.



4 PHANTOM [+48V] switch

This switch toggles phantom power for condenser microphones on and off. If you are connecting condenser microphones to the XLR-type INPUT A jacks on the rear panel, turn the switch on (). (The switch LED lights up.)

Each phantom switch turns the phantom power on and off for four channels simultaneously. (Channels 1-4 and channels 5-8 on the n12, and channels 1-4 on the n8).

NOTE When the switch is turned on, phantom power DC +48V will be supplied to Pin 2 and Pin 3 of the corresponding XLR-type INPUT A jacks.

⚠ Caution

- Be sure to leave this switch off () if you do not need phantom power.
- When turning the switch on (), make sure that only condenser microphones are connected to the INPUT A jacks. Devices other than condenser microphones may be damaged if they are connected to the phantom power supply. Note, however, that the switch may be left on when you connect balanced dynamic microphones.
- To avoid damage to your hearing or speakers, be sure to roll off the volume level of the amplifier (or powered speakers) before turning this switch on or off. Yamaha also recommends that you turn all output controls, such as the STEREO fader and [C-R PHONES LEVEL] control to minimum settings before operating the switch.

5 [PHASE] switch

Turning this switch on () inverts the phase of the signal from the input jacks. For more information on the [PHASE] switch, refer to “Tip for compensating for the phase offset” on page 15.

6 [Hi-Z] switch

If you are connecting an electric guitar or electric bass that has passive-type pickups and no built-in preamp directly to the INPUT B jack of input channel 8 (on the n12) or input channel 4 (on the n8), turn this switch on ().

NOTE Use an unbalanced cable when you connect an electric guitar or bass and turn the [Hi-Z] switch on. If you use a balanced cable, the mixer will not work correctly.

7 [INPUT SELECT] switch

This switch determines whether the input jack signal (A.IN) or the DAW signal (the output from Cubase or another DAW) will be routed to the input channels.

8 Compressor controls

These compressor controls enable you to operate the compressor for each monaural input channel (channels 1-4 on the n8, and channels 1-8 on the n12). The following two controls are available for each compressor: [MORPH] control and [DRIVE] control.

[MORPH] control

This control specifies the compressor setting. Knob positions A-E correspond to different presets. You can easily change the compressor setting by rotating the control. Knob positions between alphabetical settings will use an intermediate value taken from between two corresponding preset values.

[DRIVE] control

This control specifies the amount of compression. As you rotate the control clockwise, more compression is applied. The output level changes automatically as the amount of compression changes.

COMP LED

This LED lights up when the compressor is triggered.

NOTE For more information on how to use the compressor, please refer to page 28.

9 Equalizer (EQ)

This three-band equalizer adjusts the input channel's high, mid, and low frequency bands. You can also adjust the center frequency for the mid band.

[HIGH] gain control

This control adjusts the high band gain.

[MID] frequency control

This control adjusts the mid band center frequency.

[MID] gain control

This control adjusts the mid band gain.

[LOW] gain control

This control adjusts the low band gain.

Setting each gain control knob to the “▼” position produces a flat frequency response (no boost).

Turning the knob clockwise boosts the corresponding frequency band, while turning counter-clockwise attenuates the band.

To raise the mid band center frequency, turn the [MID] frequency control clockwise. To lower the center frequency, turn the [MID] frequency control counter-clockwise. At the center position, the center frequency is 1.0 kHz.

The following table shows the EQ type, center frequency, and maximum cut/boost for each of the three bands.

Band	Type	Center Frequency	Maximum Cut/Boost
HIGH	shelving	10 kHz	±18 dB
MID	peaking	100 Hz – 10 kHz	±18 dB
LOW	shelving	90 Hz	±18 dB

10 [REVERB] control

This control adjusts the level of the input channel signal sent to the internal digital reverb (i.e., determines how much reverb will be applied). When you set the knob to the “▼” position, the input channel signal at the nominal level (0 dB) will be sent to the internal digital reverb.

11 [AUX] control

This control adjusts the level of the input channel signal sent to the AUX bus. Use this control when you are sending a mix monitoring signal to the musicians, or sending the signal to an external device, such as an effects processor.

NOTE When the Channel Control [WET] switch is on, signals via a DAW will be directly routed to the AUX bus (Monitor Remote function). Therefore, the [AUX] control will be temporarily disabled while the [WET] switch is turned on.

12 [PAN] and [BAL] controls

[PAN] control

This control determines the stereo position of the monaural input channel. Rotate the knob clockwise to pan the signal right, and counter-clockwise to pan left.

[BAL] control

This control determines the volume balance between the left and right stereo channels. Odd channel signals are fed to the L bus, and even channel signals are fed to the R bus. For example, rotate the [BAL] control all the way to right to output only the even (right) channel signals.

13 [SOLO] switch

This switch turns the Solo function on and off. Turn this switch on (the switch LED lights up), if you want to listen to certain channels without changing the mix contents or signal path.

NOTE If you switch the monitor source by using the [C-R SOURCE SELECT] switch (page 18), all channel [SOLO] switches will be reset to off.

14 Channel [ON] switch

Switches each channel on and off. If you turn the switch on, the channel signal will be sent to each bus. When the switch is turned off (the switch indicator turns off), the channel signal will be sent only to the AUX bus.

NOTE Direct output to a connected computer is always available regardless of the channel [ON] switch status.

15 Channel fader

The channel fader adjusts the input channel signal level. The fader at the "0" position corresponds to the nominal output level. This means that the pre-fader level and post-fader level are identical.

16 Input meter

The four LEDs indicate the input channel signal level. When the input signal is clipping, the OVER LED will light up.

Only n12 You can check the level of the post-fader signal via the input meter by setting the [INPUT METER] switch (page 17) in the Meter section to "POST."

17 [WET] switch

The Monitor Remote function can be used to select whether or not the input channel monitor signal will be processed via software effects. If you turn this switch on (the LED lights up) while Cubase and the mixer are linked and operating together, you can monitor a wet signal (an input signal that has been processed via the VST or other effects).

- NOTE**
- While this switch is turned on, the [AUX] control for the corresponding input channel will be disabled.
 - To use the Monitor Remote function, you must turn on the MONITOR REMOTE [ON] switch (page 19) (the switch LED will light up).
 - This switch will work while the Cubase Direct Monitoring function is turned off when both devices Steinberg MR816 CSX/MR816 X and n8/n12 are connected to a computer. You will not be able to monitor the n8/n12 input signals while both the Cubase Direct Monitoring function and the [WET] switch are turned on.

18 [REC] switch and [ST] switch

These switches route the signal to the specified buses. Turn the [ST] switch on (the LED lights up) to route the channel signal to the stereo L/R buses. Turn the [REC] switch on to route the channel signal to the REC (L/R) buses.

Tip for compensating for the phase offset

When you are recording a single instrument using multiple microphones, the position and the distance between the instrument and microphones may cause the phase of each recorded signal to be offset against each other (out of phase). If you try to mix such signals, the signals will interfere with each other, resulting in a thin sound.

For example if you record the sound of a guitar amplifier by placing microphones in front of and behind it in order to capture the resonance of the cabinet, the microphone placed behind the amplifier will pick up a signal with an offset phase. In this case, turn the [PHASE] switch (5) on to avoid the phase offset and interference.

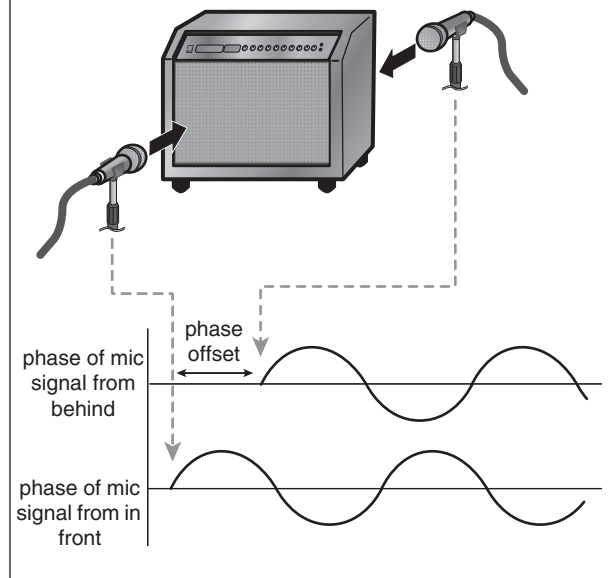

Master Control section

English

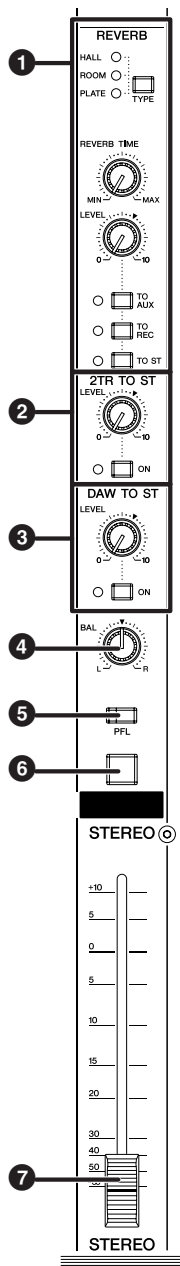

1 Reverb section

This section enables you to set the type, output level, and other settings for the internal digital reverb.

REVERB [TYPE] switch

This switch determines the type of internal digital reverb. Each press of the switch cycles through different effect types in this order: HALL → ROOM → PLATE.

HALL	Simulates reverberation in a concert hall.
ROOM	Simulates reverberation in a room.
PLATE	Simulates reverberation of a plate echo.

[REVERB TIME] control

This control adjusts the reverb time (duration of reverberation) of the internal digital reverb. Rotating the knob counter-clockwise will shorten the duration,

and rotating it clockwise will extend the duration.

REVERB [LEVEL] control

This control adjusts the output level of the internal digital reverb. The “▼” position corresponds to the nominal level (0 dB).

[TO AUX]/[TO REC]/[TO ST] switches

These switches route the output signal from the internal digital reverb to the AUX, REC, or STEREO buses. Turn the desired switch on (■) to route the output from the internal digital reverb to the desired buses.

2 2TR TO ST section

This section enables you to adjust the level of and route the signal input from the 2TR IN jacks (page 20).

[LEVEL] control

Adjusts the level of the signal input from the 2TR IN jacks. The “▼” position corresponds to the nominal level (0 dB).

[ON] switch

This switch determines whether the 2TR IN signal will be sent to the STEREO buses. When the switch is turned on (■), the 2TR IN signal is sent to the stereo buses.

3 DAW TO ST section

This section enables you to adjust the level of and route the stereo signal transmitted from the DAW (DAW IN 1/2).

[LEVEL] control

This control adjusts the level of the stereo DAW signal to the STEREO buses. The knob set to the “▼” position corresponds to the nominal level (0 dB).

[ON] switch

This switch determines whether the stereo output signal from the DAW will be routed to the STEREO buses. When the switch is turned on (■), the stereo output from the DAW will be sent to the mixer’s STEREO buses.

NOTE **Only n12** If you turn on the C-R SOURCE SELECT [5.1] switch, the DAW TO ST [ON] switch will be disabled.

4 STEREO [BAL] control

This control adjusts the left and right volume balance of the stereo channels (STEREO L/R).

5 [PFL] (Pre-Fader Listen) switch

If you want to monitor pre-fader input channel signals when you are using the Solo function, turn this switch on (■).

NOTE **Only n12** While this switch is turned on, if you also turn the [SOLO] switch on, the monitor signal volume may become very loud. In this case, use the [SOLO LEVEL] control (page 17) to adjust the monitoring volume level. The monitoring volume level of the n8 is always attenuated by 12 dB.

6 STEREO [ON] switch

This switch turns on and off the signal output from the ST OUT jacks. When the switch is on (■), the signal is output from the ST OUT jacks.

7 STEREO fader

This fader adjusts the level of the signal output from the ST OUT jacks. The “0” position corresponds to the nominal output level (0 dB).

Meter section

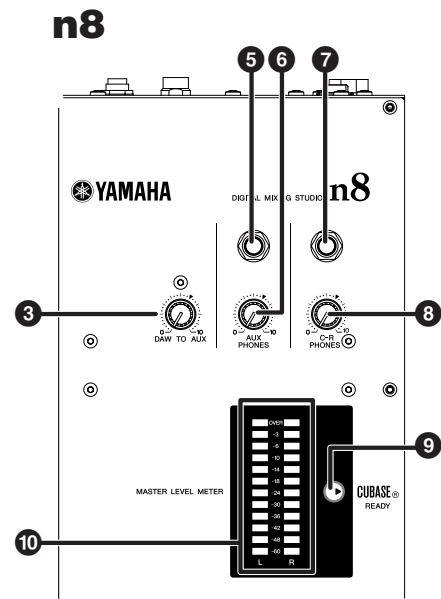
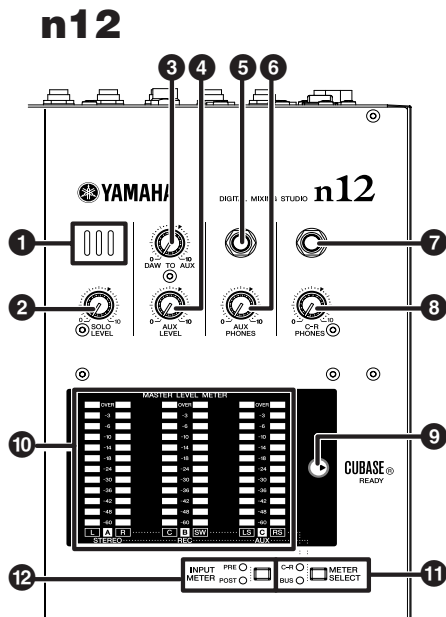

- 1 Microphone** Only n12
This is a built-in talkback microphone.
 - 2 [SOLO LEVEL] control** Only n12
This control adjusts the SOLO L/R bus output level. The adjustable range is from $-\infty$ to +6 dB. The “▼” position corresponds to the nominal output level (0 dB).
 - 3 [DAW TO AUX] control**
This control adjusts the level of the signal routed from the DAW AUX output (n12= DAW IN 15/16, n8= DAW IN 11/12) to the AUX buses. The “▼” position corresponds to the nominal output level (0 dB).
 - 4 [AUX LEVEL] control** Only n12
Adjusts the AUX OUT signal level (page 21). The “▼” position corresponds to the nominal output level (0 dB).
- NOTE** While you are using the Monitor Remote function (page 33), signals that pass through the DAW will be directly routed to the AUX bus.
- 5 AUX PHONES jack**
This headphone connector outputs the AUX bus signal. Use this connector to send a monitor signal to the musicians. The output level at this jack can be adjusted independently of the AUX OUT jacks.
 - 6 [AUX PHONES] control**
This control adjusts the output level at the AUX PHONES jack. The “▼” position corresponds to the nominal output level (0 dB).
 - 7 C-R PHONES jack**
This headphone jack outputs the control room signal. The output level at this jack can be adjusted independently from that of the C-R OUT jacks.
 - 8 [C-R PHONES] control**
This control adjusts the output level at the C-R PHONES jack. The “▼” position corresponds to the nominal output level (0 dB).

- 9 CUBASE READY indicator**
This indicator lights up when the mixer is ready to be operated with Cubase 5/Cubase 4/Cubase Studio 5/Cubase Studio 4/Cubase Essential 5/Cubase Essential 4/Cubase AI 5/Cubase AI 4; that is, when the computer is connected to the n8/n12 and Cubase is linked to the mixer correctly.
- 10 MASTER LEVEL METER**
 - **n12**
This meter indicates the level of the STEREO/REC/AUX bus signals, or the output level at the C-R OUT jack. To switch the meter view, use the [METER SELECT] switch (11). Depending on the setting of the [METER SELECT] switch, the meter indication will change as follows:

[METER SELECT] switch	Meter A	Meter B	Meter C
C-R*	C-R OUT jacks A (L/R)	C-R OUT jacks B (C/SW)	C-R OUT jacks C (LS/RS)
BUS	STEREO bus	REC bus	AUX bus

* Surround channels are indicated in parentheses.

- **n8**
This meter indicates the output level at the C-R OUT jacks.
- 11 [METER SELECT] switch** Only n12
This switch determines which signal will be indicated via the MASTER LEVEL METER. Pressing the switch will toggle between C-R (C-R OUT jacks) and BUS (STEREO/REC/AUX bus).
- 12 [INPUT METER] switch** Only n12
This switch selects the signal whose level is indicated on the input meter (page 15) in the Channel Control section. Pressing the switch repeatedly toggles between PRE (pre-fader) and POST (post-fader).

English

Control Room section

English

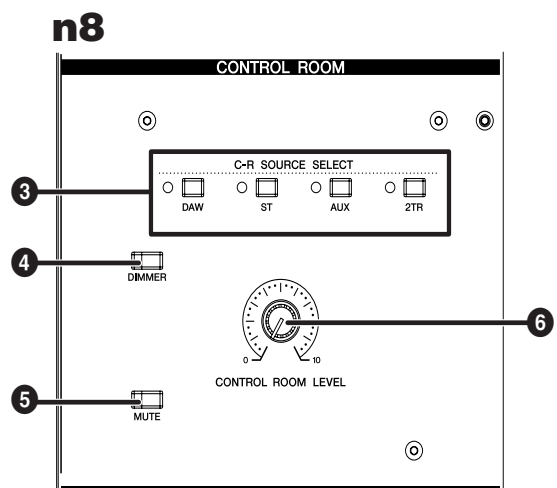
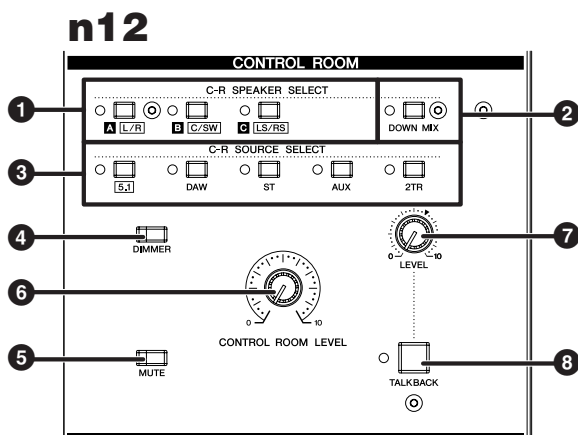

1 C-R SPEAKER SELECT switches Only n12
 These switches select the jacks that will output the control room monitor signal. When you turn on one of the switches, the LED lights up, and the corresponding jacks output the monitoring signal.

Switch	Output jacks
C-R SPEAKER SELECT [A] switch	C-R OUT jacks A (L/R)
C-R SPEAKER SELECT [B] switch	C-R OUT jacks B (L/R)
C-R SPEAKER SELECT [C] switch	C-R OUT jacks C (L/R)

NOTE While the C-R SOURCE SELECT (3) [5.1] switch is turned on, you can use these switches to individually turn the surround channels on and off. For more information, please refer to page 47.

2 [DOWN MIX] switch Only n12
 This switch converts 5.1-ch surround signals (input from the DAW) into 2-ch L/R signals. While the switch is on, converted 2-ch signals are output from the C-R OUT jacks A.

NOTE • In order to monitor in a surround environment, you will need a surround-capable application such as Cubase 5. The included Cubase AI does not support surround.
 • This switch is effective only while the C-R SOURCE SELECT [5.1] switch is turned on.

3 C-R SOURCE SELECT switches
 These switches enable you to select a monitoring source (the signal output from the C-R OUT jacks). The following switches and monitoring sources are available:

[5.1] switch Only n12	Enables you to monitor the 5.1-ch surround signal input from the DAW. (page 46)
[DAW] switch	Enables you to monitor the DAW stereo signal (DAW IN 1/2).
[ST] switch	Enables you to monitor the STEREO bus signal.
[AUX] switch	Enables you to monitor the AUX bus signal.
[2TR] switch	Enables you to monitor only the input signal at the 2TR IN jacks.

NOTE • Only n12 In order to monitor in a surround environment, you will need Cubase 5. The included Cubase AI does not support surround.
 • You can turn on the [5.1] switch and [ST] switch simultaneously. In this case, the 5.1-ch L/R signal and STEREO bus L/R channel signals will be mixed and output.

4 [DIMMER] switch
 This switch turns on and off the Dimmer function that temporarily lowers the monitoring volume. For example, this can be convenient when you want to have a conversation in the control room.

5 [MUTE] switch
 This switch turns on and off the Mute function that mutes the monitoring signal. Repeatedly pressing the switch toggles between on (the switch will light up) and off (the switch will turn off).

6 [CONTROL ROOM LEVEL] control
 This control adjusts the monitoring volume in the control room. Turning the knob clockwise will increase the volume level.

7 TALKBACK [LEVEL] control Only n12
 This control adjusts the input level of the built-in microphone. The “▼” position corresponds to the nominal level (0 dB).

8 [TALKBACK] switch Only n12
 While this switch is being pressed, you can communicate with the musicians (Talkback function). When the Talkback function is turned on, the switch LED will flash and the Dimmer function (4) will be enabled.

NOTE The talkback signal will be sent to the AUX outputs (AUX PHONES jack and AUX OUT jacks).

DAW Remote Control section

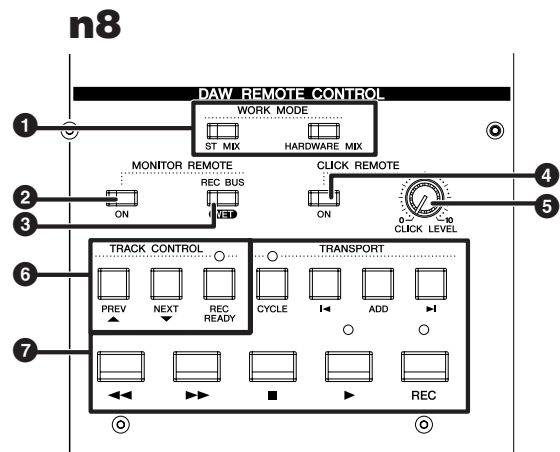
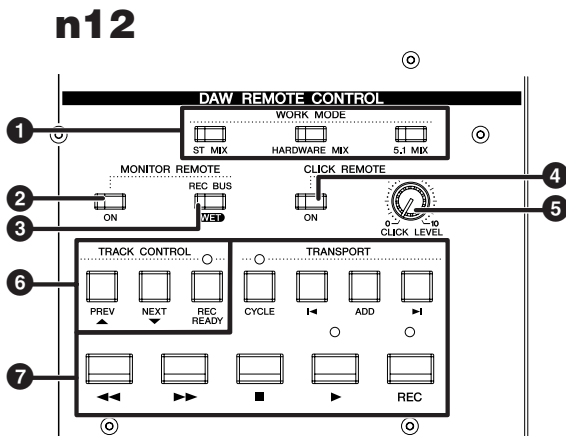

NOTE All switches in this section are enabled only when the n8/n12 is connected to the computer via an IEEE1394 cable and the mixer's operation is linked to Cubase 5/Cubase 4/Cubase Studio 5/Cubase Studio 4/Cubase Essential 5/Cubase Essential 4/Cubase AI 5/Cubase AI 4. For more information on the Cubase Link function, please refer to page 33.

1 WORK MODE switches

These switches enable you to change the connection status between the n8/n12 and Cubase all at once. The following connection settings (Work modes) can be selected depending on your needs. Pressing each switch changes I/O settings and bus assignments.

ST MIX	Enables you to monitor on the n8/n12 the stereo signal mixed in the Cubase mixer and output from the DAW.
HARDWARE MIX	Enables you to output Cubase audio tracks individually to the n8/n12, then mix them on the n8/n12.
5.1 MIX <small>Only n12</small>	Enables you to create a 5.1-ch surround mix in Cubase 5/Cubase 4.

NOTE For information on operations in each Work mode, please refer to page 36.

2 MONITOR REMOTE [ON] switch

This switch turns on and off the Monitor Remote function that enables you to process the input channel and REC bus signals via the VST effects and monitor them. When the switch is turned on (the switch will light up), the input channel [WET] switches (page 15), the MONITOR REMOTE [REC BUS WET] switch (3), and other switches become available.

3 MONITOR REMOTE [REC BUS WET] switch

This button determines how to monitor the signals that is being recorded via the REC bus with the Monitor Remote function (page 33). When this switch is on, you can monitor the REC bus signals that have been processed within Cubase by VST effects, etc.

- NOTE**
- To use the Monitor Remote function, turn on the MONITOR REMOTE [ON] switch (2) (the switch LED will light up).
 - To monitor an effect signal that has been processed by the VST effects, you must turn on the Record Enable button for the destination audio track in Cubase.

4 CLICK REMOTE [ON] switch

This switch remotely turns on and off the metronome (click sound) in Cubase. If you turn the metronome ON in Cubase, this switch will reflect the setting.

5 [CLICK LEVEL] control

This control adjusts the volume level of the Cubase metronome (click sound). Turning the knob clockwise will raise the volume, and turning the knob counter-clockwise will lower the volume.

6 TRACK CONTROL switches

These switches remotely control Cubase tracks. Each switch features the following function:

[PREV ▲] switch	Selects the previous track (the track one above in the track list) in Cubase.
[NEXT ▼] switch	Selects the next track (the track one below in the track list) in Cubase.
[REC READY] switch	Turns on and off the Record Enable button for the track selected in Cubase.

7 TRANSPORT switches

These switches remotely control the transport section in Cubase. Each switch has the following function:

[CYCLE] switch	Turns Cycle mode on and off.
[◀] switch	Moves the current position to the previous marker (or the beginning of the project if there is no marker in the backward direction).
[ADD] switch	Adds a marker at the current position.
[▶] switch	Moves the current position to the next marker.
[◀◀] switch	Rewind
[▶▶] switch	Fast forward
[■] switch	Stops the project playback.
[▶] switch	Plays the project.
[REC] switch	Records the track(s) whose Record Enable button is on

Rear I/O section

n12

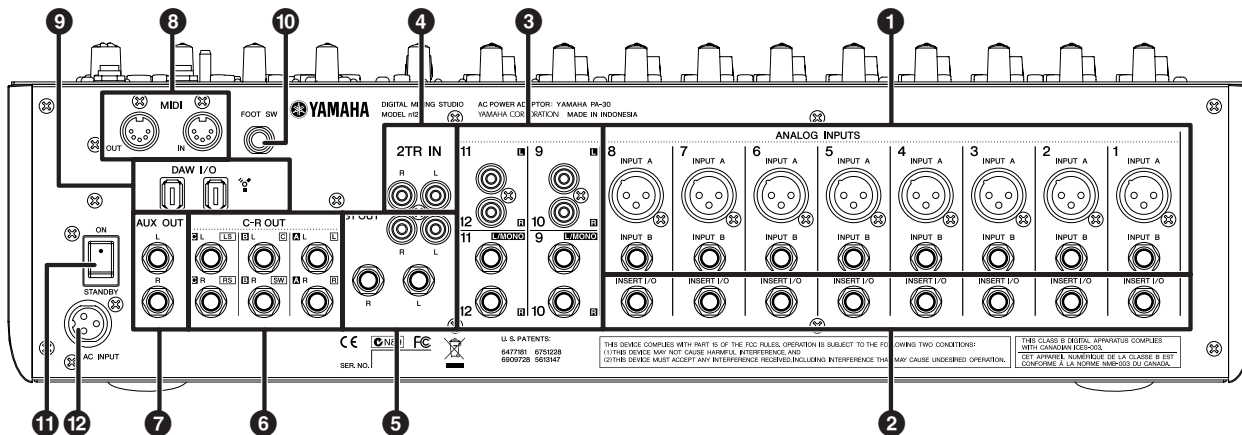

n8

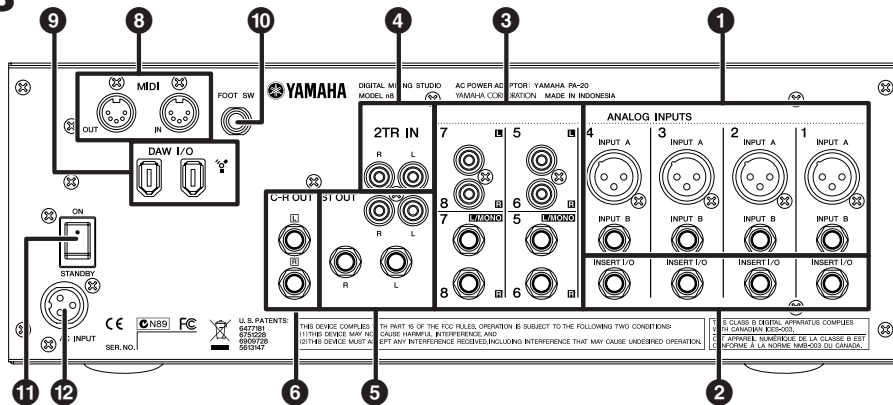

1 ANALOG INPUT jacks (monaural)

These monaural channel input jacks are used to connect microphones or musical instruments. Each input channel features two types of jacks (INPUT A and INPUT B).

INPUT A jacks

These are balanced XLR-type input jacks.

INPUT B jacks

These are balanced TRS phone-type input jacks that also support unbalanced connections.

NOTE You may use either of these jacks, but you may not use both at the same time. If you connect cables to both jacks, INPUT B jack will take priority.

2 INSERT I/O jacks

These phone-type unbalanced I/O jacks are positioned immediately before the A/D converter. You can connect your effects processor or other devices directly to these input channels.

NOTE These are TRS phone jacks that support bidirectional operation. Connection to an INSERT I/O jack requires a special insertion cable as illustrated below. Use a separately-sold Yamaha insertion cable (YIC025/050/070).

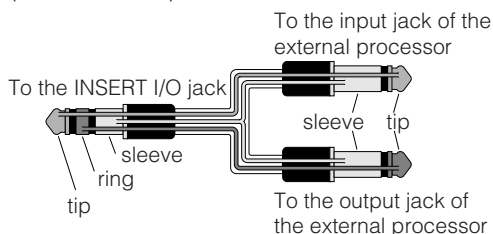

3 ANALOG INPUT jacks (stereo)

These are stereo input jacks that connect line-level instruments, such as a synthesizer. Two jack types are provided: phone type and RCA pin type.

Phone type

These are unbalanced stereo input jacks.

RCA pin type

These are unbalanced stereo input jacks. Connect odd channels to the L jacks, and even channels to the R jacks. If you connect only odd channels to the phone-type jacks, the same signals will be fed to the even channels, resulting in monaural inputs.

NOTE If you connect cables to both phone type and RCA pin type jacks, signals are mixed before the [GAIN] control, then input to the corresponding channel.

4 2TR IN jacks

Use these unbalanced RCA pin jacks to input a stereo sound source.

Use these jacks when you want to connect a CD or other music source to the n8/n12 for monitoring. You can adjust the level of signals input via these jacks using the [2TR TO ST] control (page 16) in the Master Control section.

5 ST OUT jacks

These stereo jacks output the mixed signal, and are suitable for use as the main output for a small concert or other event. The signal level is adjusted via the STEREO fader, then the signal is output from these jacks. You can use these jacks, for example, to send the stereo mix to the master recorder, or to connect to the power amplifier driving your main speakers.

These jacks feature two types: phone type and RCA pin type, and the same signal will be output from either type of jack.

Phone type

These are stereo output jacks that support both balanced and unbalanced signals.

RCA pin type

These are unbalanced stereo output jacks.

6 C-R OUT jacks

These are stereo output jacks that support both balanced and unbalanced phone-type connections for the Control Room monitor.

The signal level is adjusted in the Control Room section (page 18) before it is output.

Only n12 The signal monitored by these jacks is selected via the C-R SPEAKER SELECT switches (page 18).

7 AUX OUT jacks **Only n12**

These stereo jacks output AUX bus signals. They support both balanced and unbalanced phone-type connections. You can use these jacks, for example, to connect musicians' monitor speakers, or to send the input channel signal to a connected external device, such as an effects processor.

The output level at these jacks can be adjusted via the [AUX LEVEL] control (page 17) in the Meter section.

8 MIDI IN/OUT jacks

These jacks are used to connect external MIDI devices, such as a synthesizer, via MIDI cables. If you are connecting the n8/n12 to a computer via an IEEE 1394 cable, these jacks serve as a MIDI interface that connects the computer to external MIDI devices.

9 DAW I/O jacks

These 6-pin IEEE 1394 (S400) jacks are used to connect a computer to the mixer via a IEEE 1394 cable. Both jacks feature the same functionality. You can use one of them to connect a computer, and the other connector to connect daisy-chained devices. If your computer has a 4-pin IEEE 1394 jack, use a 4-pin to 6-pin type IEEE 1394 cable that meets the S400 specifications.

Caution

Be sure to connect the IEEE1394 cable plug to the DAW I/O jack in the correct orientation.

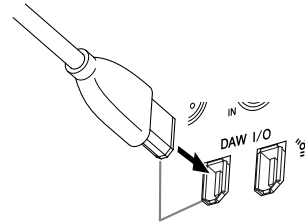

Plug in the jack in the correct orientation.

NOTE

- Use an IEEE 1394 cable that meets the S400 standard. Yamaha recommends that you use an IEEE 1394 cable with a length of 4.5 meters or less.
- Connect your IEEE 1394 cables so that they do not create a loop. For more about loop connections, refer to page 53.

10 FOOT SW jack

Connect an optional foot switch (such as Yamaha FC4 or FC5) to this jack. In this way, you can control the transport functions of Cubase 5/Cubase 4/Cubase Studio 5/Cubase Studio 4/Cubase Essential 5/Cubase Essential 4/Cubase AI 5/Cubase AI 4 using your foot. By default, the foot switch will operate as the Mackie Control "USER SWITCH (A)." If necessary, you can make settings within your DAW to change the assignment.

With the default settings in Cubase, this will perform the same operation as the [REC] button.

11 POWER switch

This switch sets mixer power to ON or STANDBY.

Caution

Note that a small amount of current continues to flow while the switch is in the STANDBY position. If you do not plan to use the mixer for a long period of time, please be sure to unplug the adaptor from the wall outlet.

12 AC INPUT jack

Connect a power adaptor here (refer to page 8).

Setting Up the Mixer

Setup Procedure

1. Before connecting microphones and other instruments to the mixer, make sure that the power to all devices is turned off. Also, make sure that all of the mixer's channel faders and master control faders are set all the way down.
2. For each channel connection, connect one end of the cable to the relevant microphone or instrument and securely connect the other end to the appropriate input jack on the mixer.

NOTE You cannot use both INPUT A and INPUT B jacks for each input channel. If you connect cables to both jacks, INPUT B will be used and INPUT A will be disabled.

3. To avoid loud pop noises and possible damage to your speakers, turn on the power to the devices in the following order: peripheral devices → n8/n12 → power amps (or powered speakers). Turn off the power to the devices in the reverse order: power amps (powered speakers) → n8/n12 → peripheral devices).

n12 Setup Example (Home recording)

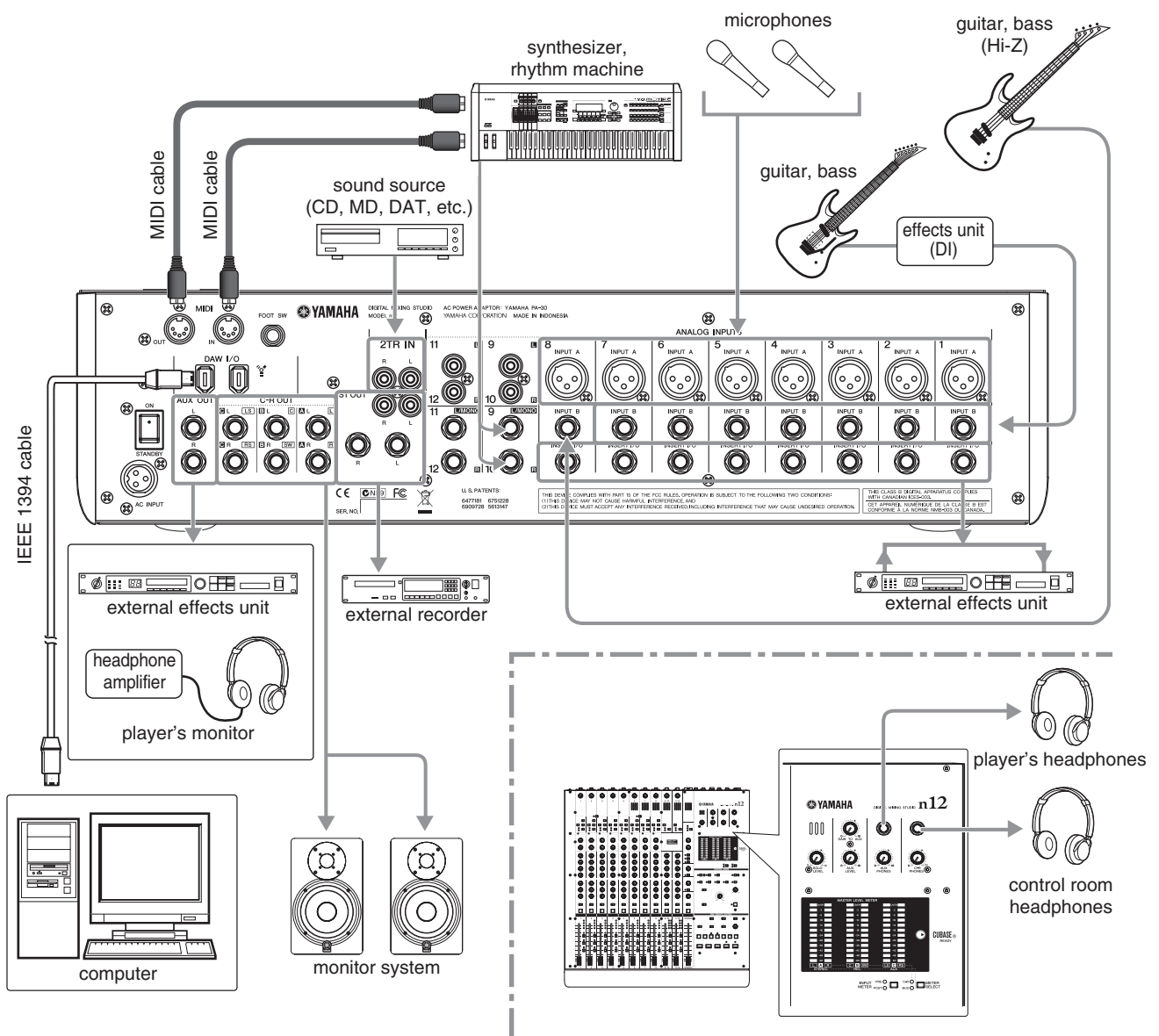

n8 Setup Example (Home recording)

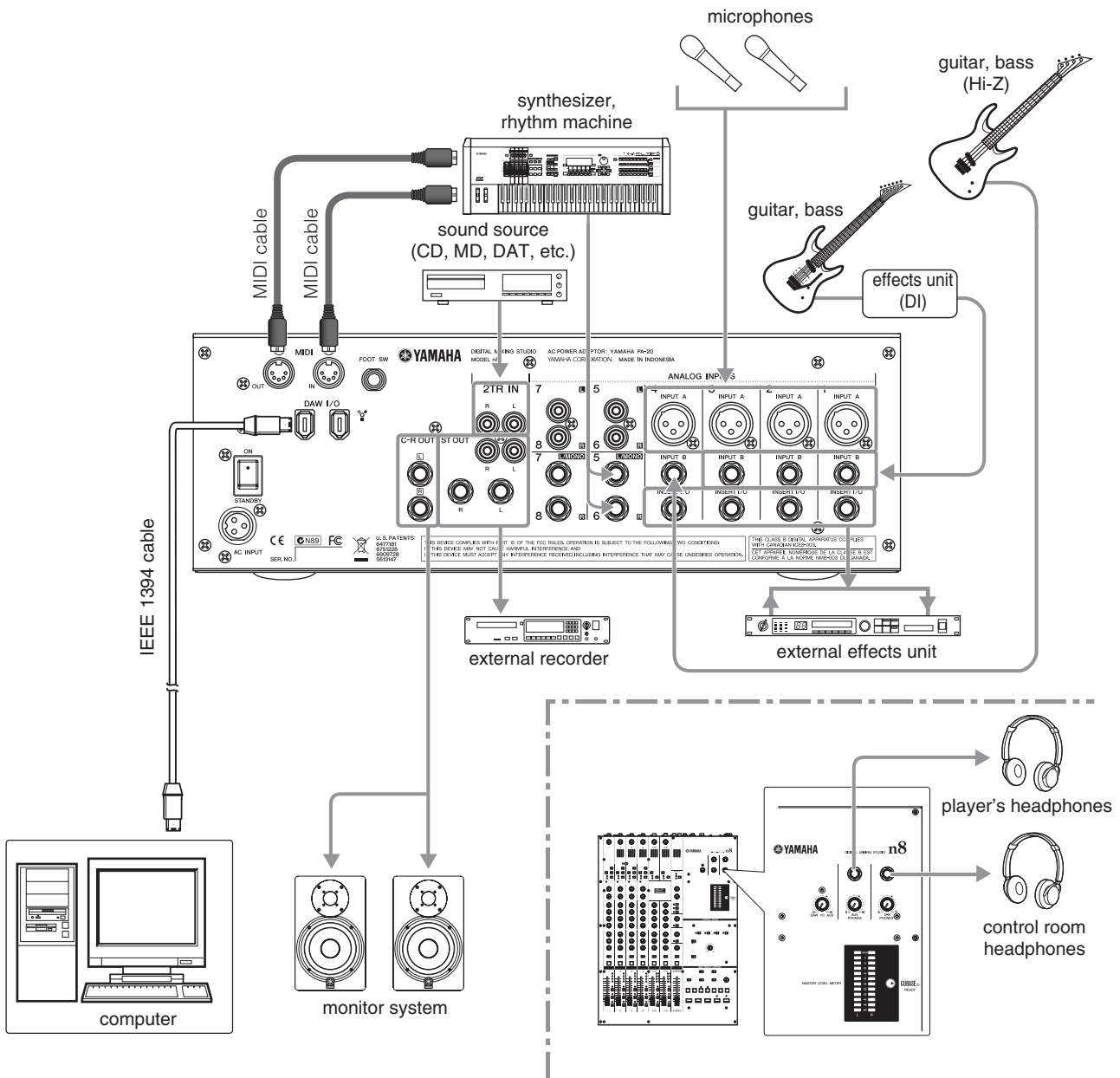

English

Installing Monitor Speakers

The position of the monitor speakers is very important for accurate sound monitoring. Refer to the following tips before you decide on a location and position for the monitor speakers.

Distance from the walls and corners

To monitor the sound accurately, locate the speakers far from the walls and corners. As the speakers move closer to the walls or corners, sound reflection from the walls will emphasize the low range, reducing the quality of the speaker response. (Ideally, keep a distance of minimum 1.5 meters from the walls.) If you have no other choice, adjust the frequency response for the monitoring environment (such as equalizing the speaker frequencies) or slightly cut the low range during the mix.

Distance and angle from the listening point

Place L and R channel speakers so that they and the listening point will form an equilateral triangle. Position the speakers so that the face of the speakers are pointing toward the listening point. Keep an equal distance between the speaker and the listening point for each speaker so that the left and right monitor signals will be well-balanced. Adjust the speaker height so that the tweeter will be at the same height as your ears. In this way, you will be able to hear higher ranges, which project at a narrow angle.

A Hands-On Guide to the n8/n12

Here are the basics for using your n8/n12 as a stand-alone mixer.

Let's Hear It!

Connecting sound sources and monitor devices

Nothing happens until you connect musical instruments, microphones, other sound sources, and monitoring speakers to the mixer and turn on the power to the mixer. So...

1. **Make sure that the power to all devices is turned off, then connect musical instruments, microphones, and other sound sources to the mixer.**

Refer to "Setup Procedure" on page 22 for more information on connections.

If you are connecting an electric guitar or electric bass that has passive-type pickups and does not have a built-in preamp, connect it to input channel 8 (on the n12) or input channel 4 (on the n8), and press the [Hi-Z] switch of that channel to the on () position. If you connect a guitar or bass to other channels, use a DI box (direct box) or amp simulator between the instrument and the mixer.

 When you use condenser microphones, turn the corresponding channel PHANTOM [48V] switches on.

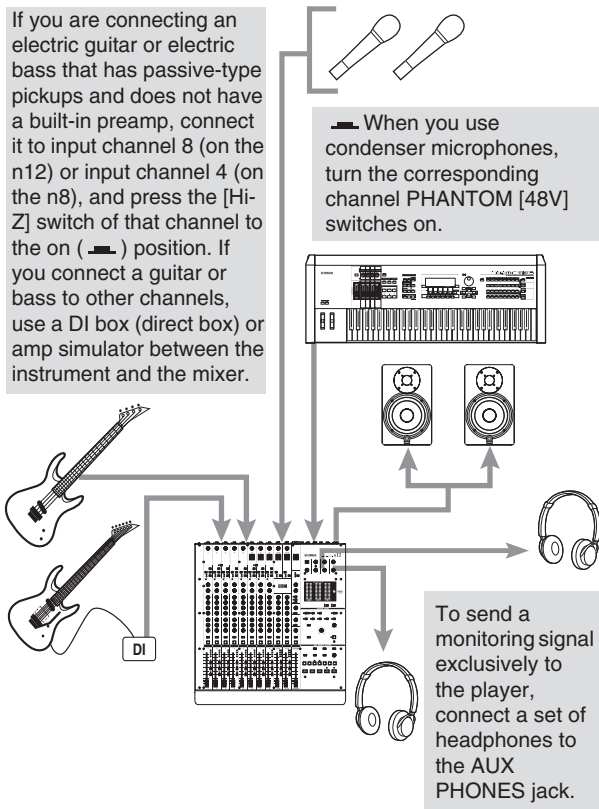

To send a monitoring signal exclusively to the player, connect a set of headphones to the AUX PHONES jack.

Caution

- Make sure that the PHANTOM [48V] switch is turned off () when phantom power is not required.
- Make sure that NO equipment other than phantom-powered microphones is connected to the channel inputs when the corresponding channels' phantom power is on. Applying phantom power to equipment other than phantom-powered microphones can damage the equipment. The exception to this rule is balanced dynamic microphones, which can safely be left connected while phantom power is applied to the XLR inputs.
- When you switch phantom power on or off, a loud noise may be output, which could result in speaker or hearing damage. To avoid this, lower the level of your power amplifier (or powered speakers) to minimum before switching phantom power on or off. Also, set the STEREO faders, [PHONES LEVEL] control, and other output level controls to the minimum levels.

2. **Set all faders on the mixer to minimum.**

3. **Turn on the power to all the devices in the following order: connected instruments and microphones → n12/n8 → monitor speakers.**

Make sure that you turn on the power to the devices starting with the input sources in the order of connection. Otherwise, a rather loud noise may blow you away!

A good rule of thumb for recording via microphones is to turn the high-pass filter on for microphone channels, except in very special cases. As the name implies, a "high-pass filter" cuts only those signals that fall below a certain frequency. When an n12/n8 high-pass filter is turned on, signals below 80 Hz (which are very low frequency components) are cut. This can be useful for minimizing low-frequency breath noise from a vocalist, as well as noise caused by handling the microphone, or rumble transmitted via the microphone stand.

Adjusting the gain

A gain control is used to match the input's sensitivity to the signal from, for example, connected instruments or microphones. The n12/n8 enables you to input two signal types: analog signals from instruments or microphones connected to the rear panel, and digital signals transferred from Cubase or other DAWs. Here is how you select analog signals as input sources and adjust the input sensitivity.

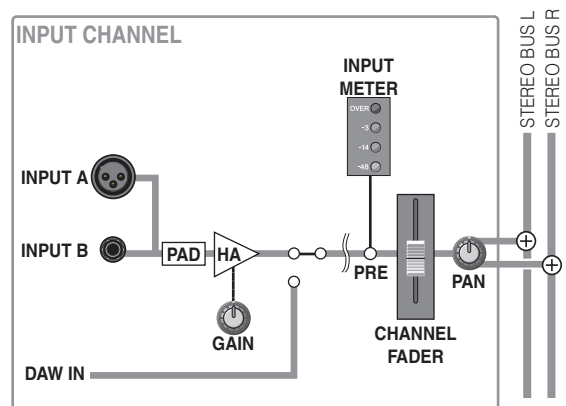

1. **Set the [INPUT SELECT] switch of the input channel that is connected to your musical instrument to "A.IN."**

When the switch is set to "A.IN.," analog signals will be input to the corresponding input channel.

NOTE  When the [INPUT SELECT] switch is set to "DAW.," you can input signals from Cubase or another DAW to the input channels. For more information, please refer to page 43

2. If you are using the n12, set the [INPUT METER] switch in the Meter section to “PRE.”

You can select pre-fader signal level or post-fader signal level for the input meters. (A “pre-fader” signal is taken from a point before the channel fader. A “post-fader” signal is taken from a point after the channel fader.) As you might guess, the meters will display pre-fader signal levels if you select “PRE,” and post-fader signal levels if you select “POST.” When you are adjusting the input sensitivity (gain), keep your eyes on the pre-fader signal meters.

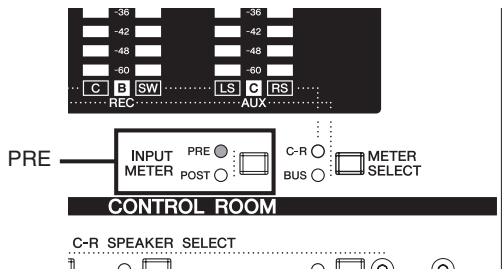

NOTE If you are using the n8, the meters always display pre fader signal levels.

- 3. Turn the [PAD] switch on or off for each monaural input channel, depending on the connected instrument or microphone.**
- 4. While playing the instrument or singing into the microphone at the loudest expected level, gradually rotate the corresponding [GAIN] control clockwise without the input meter’s OVER LED lighting up.**

In order to record the sound with a wide dynamic range and minimum noise, raise the input sensitivity as high as possible without the input signal clipping.

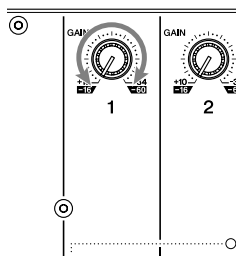

NOTE To achieve a clear sound with the least noise, amplify the input to the desired average level as early as possible in the signal path. That means that you should amplify the input using the [GAIN] control in the head amplifier as much as possible. But, remember: too much initial gain is bad, because it will cause clipping, and will distort the sound. Amplify the signal to a level “just below clipping.”

Setting up the monitoring environment

Of course you need to hear what is going on, right? That is called “monitoring.” You can monitor the input channel signals through connected monitor speakers or headphones.

The n12 also provides C-R SPEAKER SELECT switches that let you select one output destination from multiple monitor speakers.

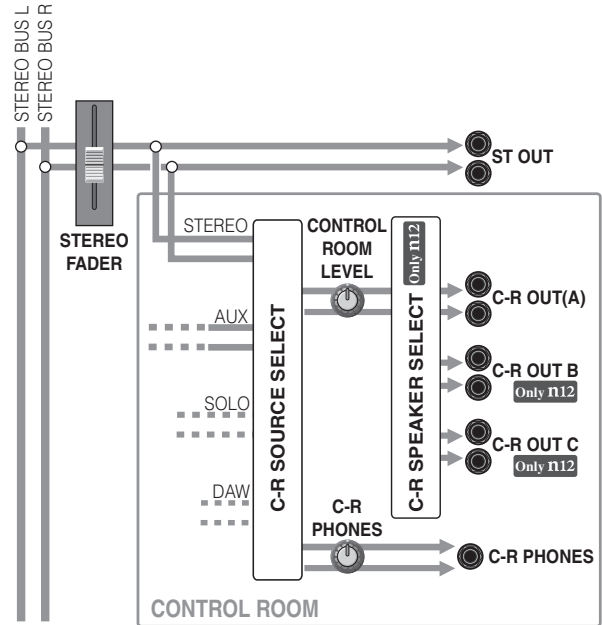

1. Turn on the appropriate Control Room [C-R SOURCE SELECT] switch corresponding to the signals that you want to monitor.

The following signals are available as monitoring sources in the control room:

[5.1] switch Only n12	Enables you to monitor a 5.1 channel surround signal input from the DAW.
[DAW] switch	Enables you to monitor the DAW stereo output (DAW IN 1 & 2).
[ST] switch	Enables you to monitor the stereo bus signal.
[AUX] switch	Enables you to monitor the AUX bus signal.
[2TR] switch	Enables you to monitor the input signal from the 2TR IN jacks.

The C-R SOURCE SELECT switch indicators will tell you which monitor source is currently selected. In this example, press the [ST] switch to select the stereo bus signal as a monitor source.

2. Turn the [CONTROL ROOM LEVEL] control or [C-R PHONES] control to adjust the monitoring level.

You can adjust the level of each monitor individually. To adjust the monitor speaker level, use the [CONTROL ROOM LEVEL] control. To adjust the Control Room headphone level, use the [C-R PHONES] control. To avoid damages to your hearing ability and/or speakers during monitoring, set the monitoring level rather low, then re-adjust the level later to suit your taste during mixing.

3. **Players want to hear what is going on. Use the [AUX] control of the input channel that connects the instrument or microphone to adjust the output level to the AUX bus so that the corresponding player or singer can hear their part.**

The AUX bus can be used in various ways. Two common applications are 1) to create a monitor mix that is separate from the main mix and that can be used by players in a recording booth or on the stage, and 2) to process the signal via an external effect unit, such as reverb and delay.

On the n8/n12, a pre-fader signal is routed from each input channel to the AUX bus. You can create an independent monitor mix by setting each input channel [AUX] control to a mix balance that is different from the fader setting.

The AUX bus signal is output from the AUX PHONES jacks (or the AUX PHONES jacks and AUX OUT jacks on the n12). Rotate the level control of the corresponding jacks to adjust the monitoring level. To avoid damage to your hearing or speakers, set the monitoring level rather low, then re-adjust the level later to suit your taste during mixing.

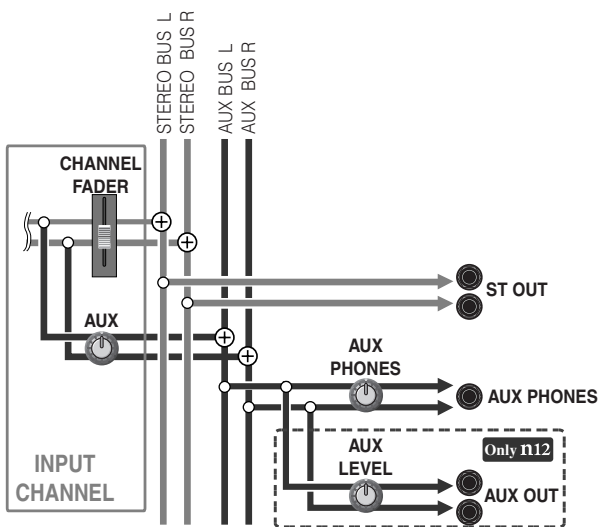

Adjusting the volume level

Adjust the volume level while monitoring the input channel signals.

1. **Press the STEREO [ON] switch in the Master Control section to turn it on, then raise the STEREO fader to the “0 (0 dB)” marking on the fader scale.**

When the STEREO fader is set to the 0 (0 dB) position, the stereo bus output signal is at its nominal level (that is, the pre-fader and post-fader signal are at the same level).

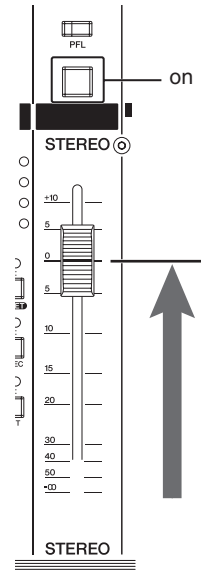

2. **Press the input channel [ON] switch and [ST] switch to turn them on.**

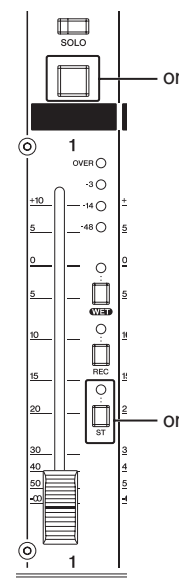

3. Adjust the volume level of the input channels to which your instruments or microphones are connected by moving the corresponding faders.

On the n12 if you set the Meter section's [INPUT METER] switch to POST, you will be able to use the input meter of each channel to check the post-fader signal level. If the C-R SOURCE SELECT [ST] switch in the Control Room section is turned on, you can monitor the STEREO bus signal in the Control Room. If necessary, re-adjust the monitoring level by rotating the [CONTROL ROOM LEVEL] control or the [C-R PHONES] control.

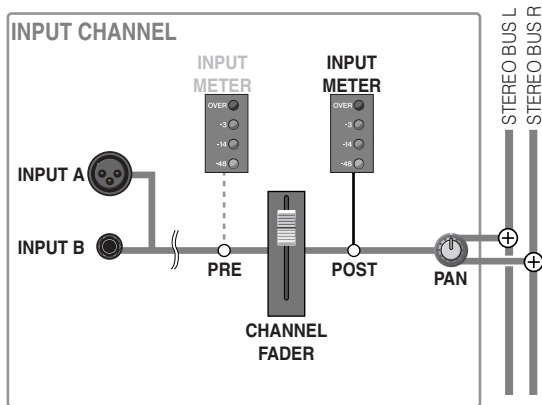
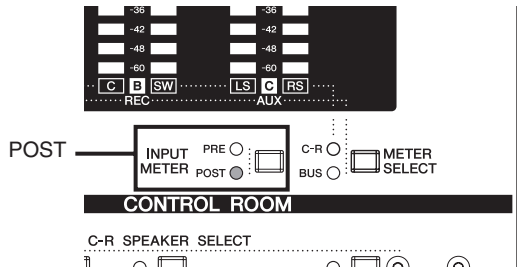

Making Great Mixes

Manipulating compression

The n8/n12 features a high-quality compressor inherited from Yamaha's cutting-edge digital mixers, acclaimed by engineers all over the world.

A compressor is an effect that restrains the peak levels of an input signal while enhancing the overall loudness of the signal. Today, compressors are used in virtually every recording environment as an important effect that significantly influences the character of the sound. However, most compressors require specialized knowledge and experience in order to obtain the optimal results. The n8/n12 use newly-developed Sweet Spot Morphing Technology to deliver professional-quality results with easy operation. The compressors of the n8/n12 contain preset settings (Sweet Spot data) that were created by top-class engineers and can be used simply by adjusting (morphing) the Sweet Spot Data according to your taste. By accessing the Yamaha website, you can download to your computer various types of Sweet Spot data created by famous engineers. The downloaded Sweet Spot data can then be replaced to the n8/n12 if it is connected to the computer.

NOTE For more information on updating Sweet Spot data, please refer to page 48.

Which compressor setting suits you?

Rotate the compressor's [MORPH] control to select one of the Sweet Spot settings. These Sweet Spot settings (A-E) contain different compressor presets (Sweet Spot data) created by famous sound engineers. Select one and the corresponding preset data will be recalled.

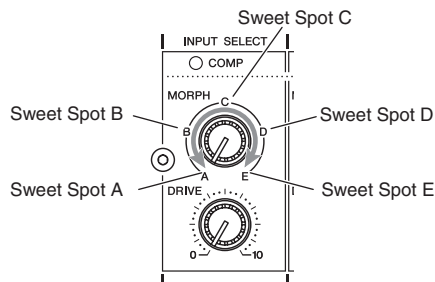

If you set the [MORPH] control to a position between two Sweet Spot settings, the compressor will use data from between those settings. For example, if you set the control to halfway between Sweet Spots A and B, the compressor will apply the values that correspond to exactly halfway between the values for Sweet Spots A and B. As you rotate the control toward the Sweet Spot B position, the values will become closer to those of Sweet Spot B. In this way, you can set the compressor on the n8/n12 more intuitively using Sweet Spot data.

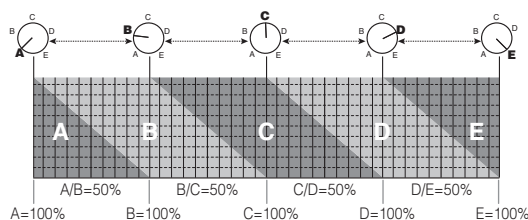

When shipped from the factory, Sweet Spots A-E use the following settings:

A	Natural-sounding compression that makes the sound smoother. We recommend that you use a fairly low depth setting for the compressor.
B	Enriches the decay of the sound.
C	Emphasizes the attack of the sound. A good choice for drums or guitar.
D	Slightly squashes the attack, making the attack more consistent.
E	Squashes the sound to make the volume constant. Depending on the input signal, the sound may distort. When applied to drums, this can produce a sound that is typical of British rock of the 60's.

Want to tweak the compression?

Use the [DRIVE] control to adjust the degree of compression. As you rotate the control clockwise, additional compression is applied, and the output level is automatically adjusted according to the degree of compression. You do not need to be a high-tech wizard to control this compressor! At a setting of "0," no compression is applied. When an input signal level exceeds a specified level and the compressor is triggered, the corresponding input channel [COMP] LED lights up. While listening carefully, adjust the sound to your taste.

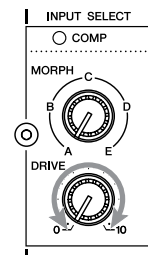

How a compressor works

A compressor suppresses the input signal peaks and raises the overall sound pressure level to increase the body of the sound. When an input signal level exceeds a specified threshold, the compressor is triggered and compresses the signal.

When the signal level falls below the threshold, compression is removed.

How quickly the signal level changes after the compressor is triggered or removed depends on the compressor's setting. For example, if you select a setting with a slow response, the level will change gradually and more naturally. If you select a setting with a quick response, the level will change quickly.

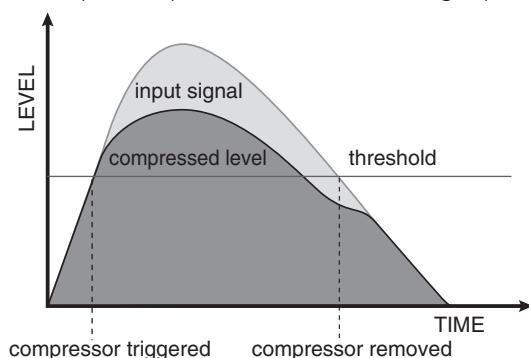

Mastery of EQ

Each input channel features a three-band (high/mid/low) equalizer.

An equalizer boosts (amplifies) or cuts (attenuates) certain frequency ranges to shape the tone. It can be used to modify the tone to suit the acoustic characteristics of a room, to make creative sounds, or for many other purposes.

One particularly important application of EQ is to give the overall sound better definition by eliminating interference between instruments' frequency ranges in a mix. Remember: less is more. Modest use of equalization will lead to a great, natural sounding mix.

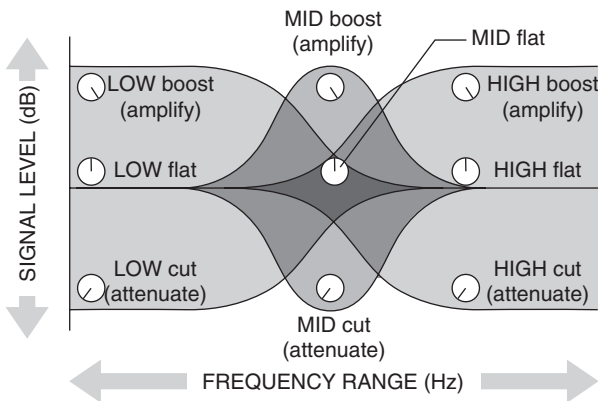

Boosting or cutting certain frequency ranges

To boost or cut certain frequency ranges of the input signal, use the gain controls for equalizer. As you rotate a control clockwise, the corresponding range will be boosted, and as you rotate the control counter-clockwise, the range will be cut. When the control is set to the “▼” position, that frequency range will not be boosted or cut (i.e., its response will be “flat”).

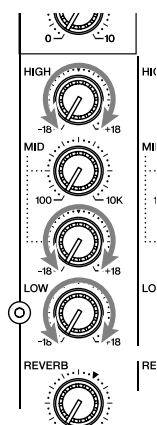

Boosting the signal too much using the equalizer will add gain to the signal, increasing noise and potentially overloading the circuitry and distorting the sound. In this case, step back and make sure that you have not boosted too much with EQ (remember, less is more!), and lower the gain if necessary.

Adjusting the mid-band center frequency

The mid-band equalizer enables you to adjust the center frequency at which the sound will be boosted or cut. This is useful when you want to adjust the boost/cut frequency ranges to accommodate a snare drum pitch or vocal tone.

To adjust this center frequency, use the [MID] frequency control. As you rotate the control clockwise, the center frequency is raised, and as you rotate the control counter-clockwise, the center frequency is lowered. When the control is set to the “▼” position, the center frequency will be 1.0 kHz.

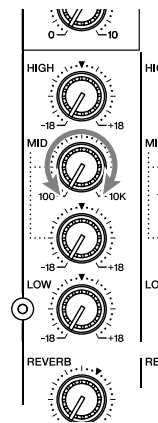

Before you adjust the center frequency, it is a good idea to boost the mid-band signal with the [MID] gain control. In this way, you can easily hear and verify the frequency that you are selecting. When you finish adjusting the frequency, re-adjust the [MID] gain control to your taste.

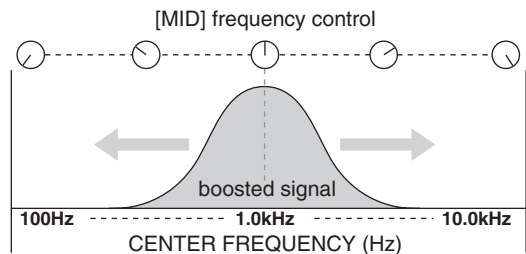

Panning and balancing

“Pan” is derived from “panorama” and is related to the concept of a “stereo image.”

Panning creates the illusion of stereo space by changing the relative levels of each track’s signal sent to the left and right speakers. If a signal is sent to only the left speaker, the sound will seem to come from the far left side of the stereo sound field. Thus we feel as though the instrument is being played on the left side. If a signal is sent at equal levels to both left and right speakers, our ears will tell us that the sound is located in the center of the stage. Not only does the way you pan your individual channels determine where the instruments seem to appear in the stereo sound field, but it is also vital to give each instrument its own “space” so that it does not conflict with other instruments.

After you finish shaping the tone of each instrument, set the stereo image for each channel and balance the overall sound. Sometimes you may want to deliberately pan sounds close together, or even right on top of each other to emphasize their relationship. There are no hard-and-fast rules. A good tip is to pan low-range instruments and any parts that are very important to the song to the center; meanwhile, pan other instruments left and right as symmetrically as possible. Normally (but this is not a rule) lead vocal, solo instruments, bass, bass drum, and snare drums will be panned to the center.

■ Panning a monaural track

Pan a monaural input channel signal by turning the [PAN] control. Rotating the control clockwise raises the ratio of signal sent to the R bus. Rotating the control counter-clockwise raises the ratio of signal sent to the L bus.

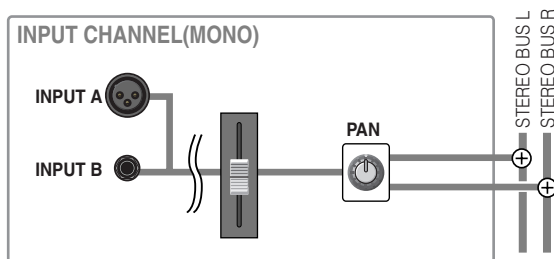

■ Adjusting the stereo track balance

Adjust the left and right volume balance of stereo channels. The odd channel signal will be sent to the L bus, and the even channel signal to the R bus.

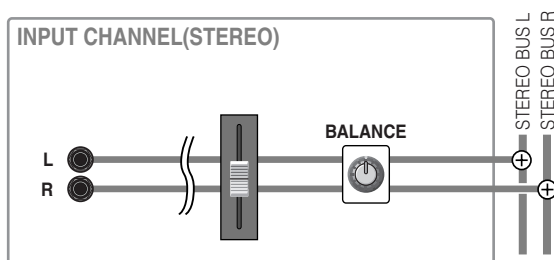

NOTE When you are using the n8/n12 as a live SR mixer, if you pan the signals or set the stereo balance hard left or hard right, the mix may not sound well-balanced to an audience sitting close to the left or right speakers. Use pan and balance with caution because mixes will sound different in live SR environments and recording environments.

Mixing into stereo

Now it is time to “mix.” Adjust the volume balance between the input channels and mix all channels into the stereo bus.

The mixed signals will be output from the ST OUT jacks and monitored through the Control Room section.

1. Lower all channel faders all the way down.

It is usually a good idea to start with all channel faders off. It is also possible to start with all faders at their nominal settings, but it is too easy to lose perspective (balance) with this approach. Start with all faders down, then bring them up one by one to fill out the mix with each instrument. In this way, you can easily create a well-balanced mix.

2. Make sure that the [ST] switch for the input channels you plan to mix is turned on.

3. Set the STEREO fader to the 0 position, and make sure that the STEREO [ON] switch is on.

4. Raise the input channel faders one by one.

Bring the fader of the most important channel up to “0” (0 dB), then add the other instruments so that you can build the mix around that part. This is a key to a well-balanced mix.

5. Adjust the STEREO fader while keeping your eyes on the MASTER LEVEL meter to avoid overloading the input signals.

The output level of the stereo mix varies depending on the input channel mix balance. To create a mix with a wide dynamic range, bring up the STEREO fader as high as possible without illuminating the OVER LED of the MASTER LEVEL meter.

Applying reverb

Using an effect unit, such as an internal digital reverb, can “effectively” add polish to a stereo mix. In this example, let’s use the internal digital reverb to apply reverb to a stereo mix.

The internal digital reverb uses its dedicated reverb bus. Send each input channel signal to the reverb bus and adjust the reverb for each channel.

The mixed signal in the reverb bus is then routed to the digital reverb. Digital reverb is then applied. You can route the output from the digital reverb to the stereo bus or other buses.

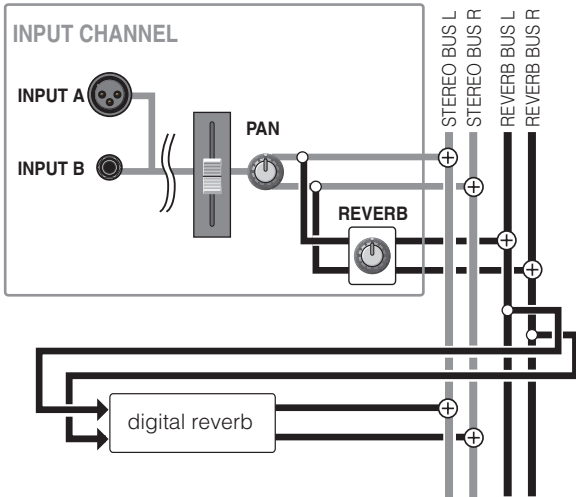

NOTE This routing is called “send and return.” It allows one effect to be shared by multiple channels. Typically, send and return routing is used for reverb and other ambient effects.

1. Press the REVERB [TYPE] switch in the Master Control section repeatedly to select the desired reverb type.

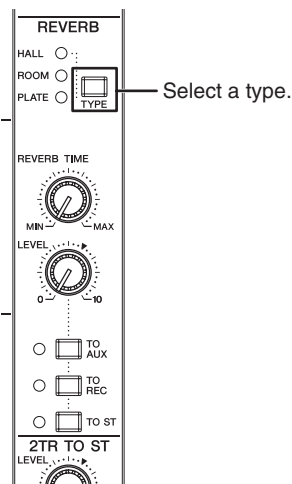

The internal digital reverb provides the following three reverb types:

HALL	Simulates reverberation of a concert hall.
ROOM	Simulates reverberation of a room.
PLATE	Simulates reverberation of a plate echo.

2. Set the [TO AUX], [TO REC], and [TO ST] switches on or off to determine the destination of the digital reverb output.

You can select multiple destination buses. If the [TO ST] switch is turned on, the digital reverb output (return signal) will be routed to the stereo bus, thus adding reverberation to the stereo mix.

If a monitoring signal is being sent to the players via the AUX bus, turning only the [TO AUX] switch on will apply reverb to only the monitoring signal, leaving the stereo mix without reverb. For example, even if you are recording a vocal without reverb, applying reverb only to the monitoring signal may help the vocalist to sing more easily or get into the “groove.” In this way, changing the destination of the reverb output enables very flexible recording.

3. Rotate each input channel [REVERB] control clockwise to adjust the digital reverb level (send level).

You can adjust the digital reverb level using the input channel [REVERB] controls. In this example, raise this send level high enough so that you will be able to listen to and check how much reverb has been applied, then fine-adjust the level later.

4. Rotate the REVERB [LEVEL] control in the Master Control section left or right to adjust the digital reverb output level (return level).

Adjusting the digital reverb output level will adjust how much reverb is applied to the entire sound. A control set to the “▼” position indicates that the output level is nominal (0 dB).

5. Rotate the REVERB [LEVEL TIME] control left or right to adjust the digital reverb duration (reverb time).

As you rotate the control counter-clockwise, the digital reverb time gets shorter. As you rotate the control clockwise, the reverb time gets longer. Adjust the reverb time until you hear the reverberation you desire.

6. If necessary, rotate each input channel [REVERB] control to fine-adjust the amount of digital reverb.

NOTE Always be careful not to apply too much reverb. Too much reverb can tip the mix balance or wash out the mix and reduce the overall clarity of the stereo image.

Soloing a channel

You can monitor only certain input channel signals. This is called the Solo function.

This function is useful when you want to listen to the performance or check the sound of only certain input channel signals selected from the stereo mix.

The n8/n12 features a dedicated solo bus (L/R), through which you can monitor pre-fader or post-fader input channels.

■ Soloing a post-fader channel signal

Turn on the [SOLO] switch of the desired input channels (the switch indicator(s) will light up).

You can turn on or off the switch for each channel individually. For example, you can listen to certain parts, such as only bass and drums, or vocal and piano, by turning on the [SOLO] switch for multiple desired channels.

When the [SOLO] switch is turned on, the monitor source for the control room will switch to the solo bus and the [C-R SOURCE SELECT] switch indicator will flash.

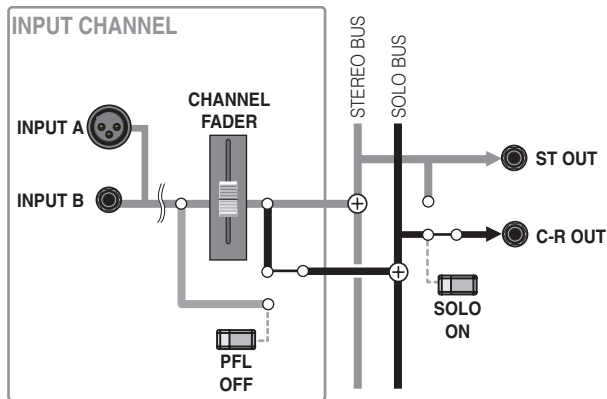

NOTE The Solo function is effective on only the monitor signal in the control room, and does not affect other output signals (such as the stereo bus or AUX bus output).

■ Soloing a pre-fader signal

To solo a pre-fader channel signal, turn on the [PFL] (Pre-Fader Listen) switch in the Master Control section, then turn on the desired input channel [SOLO] switch. This technique is useful when you want to monitor the channel signal without raising the channel fader. If the sound seems distorted, you can use this function to check whether the signal is already distorted before it passes through the fader.

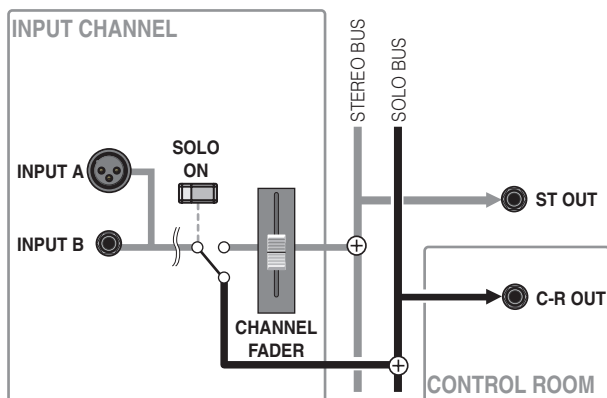

Monitoring a pre-fader signal may surprise you with its volume level, which may be much higher than expected. Check the monitoring level before you start to monitor the pre-fader signal.

On the n12, you can use the [SOLO LEVEL] control in the Meter section to adjust the output level of the solo bus.

Using the n8/n12 with Cubase 5 series

The n8/n12 features a special function that enables you to link the n8/n12 with Cubase. Using this function, you can seamlessly synchronize mixer operation with Cubase, and record and mixdown with tremendous efficiency. As an example, this section describes using Cubase 5 with the Link function.

NOTE You must have Cubase 5/Cubase 4/Cubase Studio 5/Cubase Studio 4/Cubase Essential 5/Cubase Essential 4/Cubase AI 5/Cubase AI 4 to use the Link function. Cubase SX3 and Nuendo 3 (and any previous version) are not compatible with this feature. For the most recent information on compatibility with the latest version of Nuendo, refer to the following website.
<http://www.yamahasyth.com/>

What you can do using the n8/n12 with Cubase

Linking the n8/n12 to Cubase enables you to perform many neat tricks. For example...

■ Controlling Cubase remotely

From the n8/n12 panel, you can remotely control the Cubase transport section and set up audio tracks.

■ Directly recording mixer signals to Cubase

You can record input channel signals or REC bus signals from the n8/n12 directly into Cubase. This direct recording capability is very easy and convenient.

• Direct recording of input channel signals

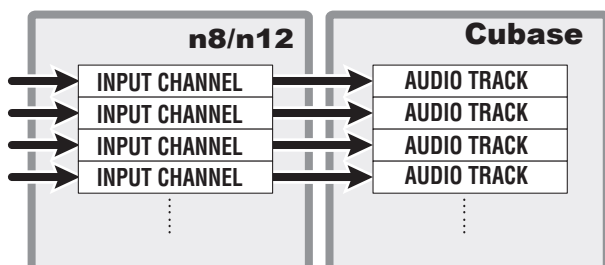

• Direct recording of REC bus signals

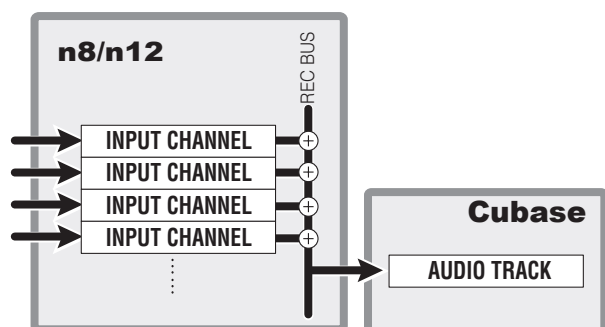

■ Turning on and off VST or other effects applied to the monitor signal

From the n8/n12 panel, you can choose whether or not you wish to monitor through the mixer the input signals processed by VST effects in Cubase. This is called the Monitor Remote function. You can easily turn this function on or off depending on the requirements of your recording environment. While the Monitor Remote function is turned on, you can monitor the input signals processed by the VST effects.

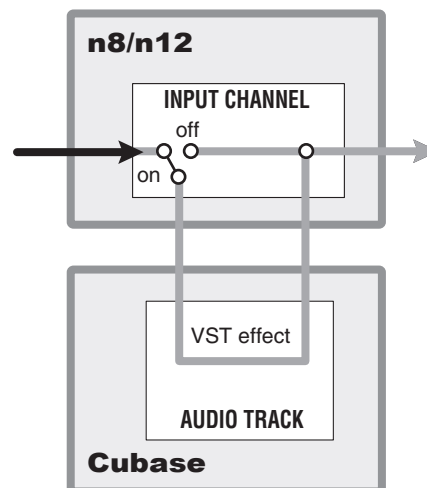

■ Mixing Cubase tracks on the n8/n12

You can add stereo signals from Cubase audio tracks to the mix on the n8/n12, or route each Cubase audio track to an individual input channel on the n8/n12.

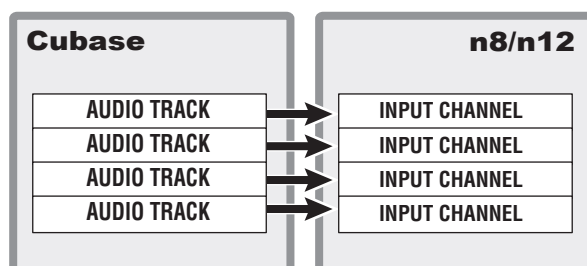

Computer setup for the Link function

Follow the steps below to set up your computer so that you can use the Link function.

NOTE Before using the Cubase Link function, you must install special drivers and software, and then make initial settings. For more information about installation procedures and initial settings for the dedicated software, please refer to the Installation Guide.

1. Start the computer.

2. Connect the n8/n12 to the computer using an IEEE 1394 cable, then turn on the power to the mixer.

3. Launch Cubase.

Windows:

Select [Start] → [All Programs] → [Steinberg Cubase 5] → [Cubase 5].

Macintosh:

Double click [Applications] → [Cubase 5].
If the Yamaha Extension dialog box is displayed while Cubase is starting, click [OK].

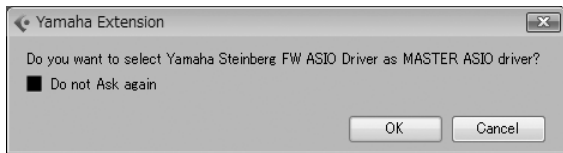

While Cubase is running, the n8/n12 can be linked to Cubase. The CUBASE READY indicator lights up.

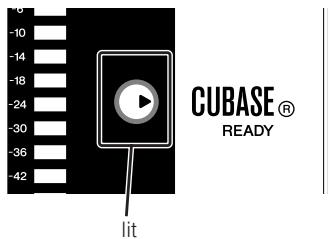

NOTE If the CUBASE READY indicator does not light up, refer to the section related to the CUBASE READY indicator in "Troubleshooting" on page 54.

4. Select [Devices] → [Device Setup...] to call up the Device Setup window. Select "VST Audio System" in the Device column then confirm whether or not "Yamaha Steinberg FW ASIO"/"Yamaha Steinberg FW" is selected from the ASIO Driver column.

If it is selected, click [OK] to close the window. The n8/n12 can now be linked to Cubase.

Confirm "Yamaha Steinberg FW ASIO"/
"Yamaha Steinberg FW" is selected.

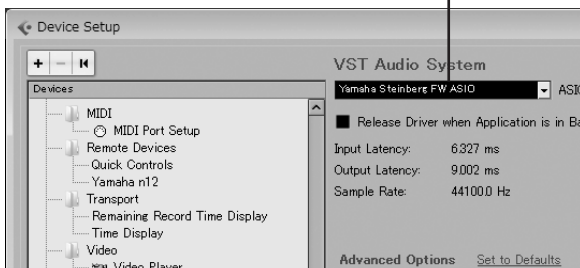

NOTE When changing the ASIO driver, a dialog box may appear asking "Do you want to switch the ASIO driver?". Click [Switch].

5. Select [File] → [Preferences] to access the Preferences dialog box.

6. From [Editing], select [Project & Mixer], and in the dialog box, make sure that "Sync Project and Mixer Selection" is checked.

If this is not checked, click the check box so that a check mark appears.

After you have verified this, click [OK] to close the dialog box.

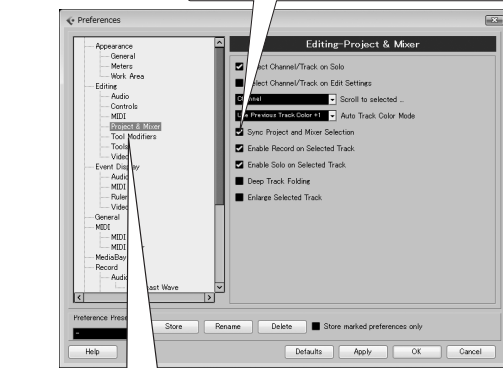
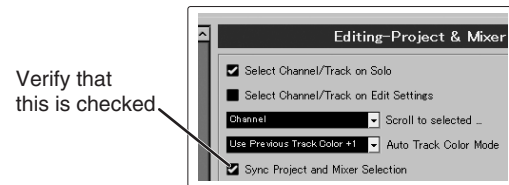

NOTE If this is not checked, the TRACK CONTROL switch of the DAW Remote Control section might not operate correctly.
This setting will be remembered the next time you start up Cubase. There is no need to make the setting each time.

7. Select New Project from the File menu to create a new project.

The Project Assistant panel opens.

Select the "Recording" category.

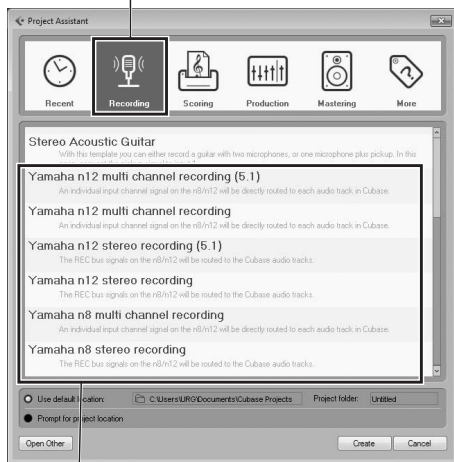

project templates for n8/n12

Two templates each are provided for the n8 and n12. These templates contain audio I/O and other preset data. You can start recording immediately after opening one of these templates.

■ Yamaha n12 multi channel recording

■ Yamaha n8 multi channel recording

An individual input channel signal on the n8/n12 will be directly routed to each audio track in Cubase.

■ Yamaha n12 stereo recording

■ Yamaha n8 stereo recording

The REC bus signals on the n8/n12 will be routed to the Cubase audio tracks.

- NOTE**
- If an n8/n12 project template is not displayed, the n Extension may not be installed correctly. Refer to the "TOOLS for n Version2/Cubase AI Installation Guide" for instructions on installing the software again.
 - For more information on the templates, please refer to the Appendix.

8. Click the name of the template you wish to use, then click [OK].

9. When the directory selection dialog box opens, specify a folder in which you wish to store the created project file and other audio files. Then click [OK].

A project window based on the selected template opens.

If you want to change the Sample Rate or routing of the input/output bus, follow the instructions below.

■ To change the Sample Rate:

Select [Project] → [Project Setup] to call up the Project Setup dialog.

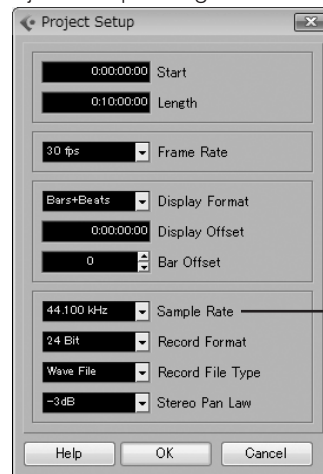

Sample Rate of the project file

After setting, click [OK] to close the dialog. According to the setting made here, the Sample Rate of the n8/n12 will be changed automatically.

■ To change the routing of the input/output bus:

Select [Devices] → [VST Connections] to call up the VST Connections window. From this window, you can change the device port of the existing bus and add the new bus.

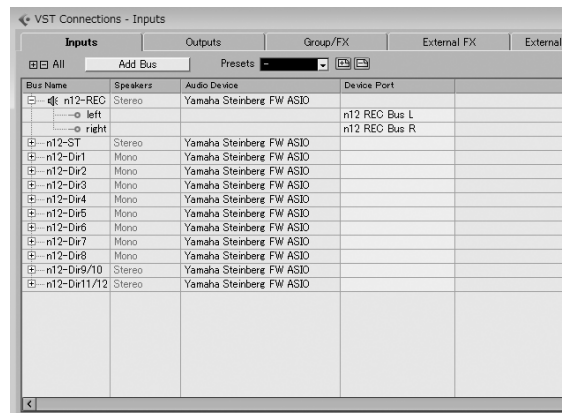

Using the Link Function

Remotely controlling the Cubase transport section and audio tracks

From the n8/n12, you can remotely control playback, recording, and other Cubase transport operations, as well as perform track operations such as selecting tracks and operating the Record Enable button.

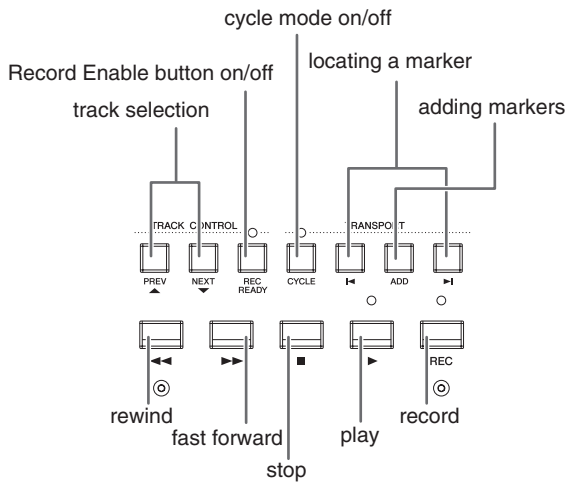

rotate this knob, then change the level in Cubase, the level of the n8/n12 metronome will change accordingly.

NOTE If the metronome is not loud enough even after you rotate the knob fully clockwise, in Cubase select [Transport] → [Metronome Setup], then maximize the level of the audio click (or the MIDI click velocity).

Selecting the Work mode

The n8/n12 enables you to select the output destination of Cubase audio tracks using just one switch. This destination setting is called "Work mode." The n8 provides two Work mode options (ST MIX and HARDWARE MIX), and the n12 provides three Work mode options (ST MIX, HARDWARE MIX, 5.1 MIX). You can change the Work mode setting at any time as appropriate for your situation. For example, you can select ST MIX for recording, then change to HARDWARE MIX for mixdown.

To select a Work mode, use the WORK MODE switches in the DAW Remote Control section.

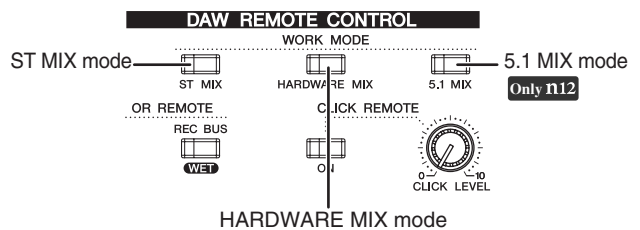

Remotely adjusting the click sound (metronome)

You can turn the Cubase metronome (click sound) on or off, and adjust the volume level directly from the n8/n12 panel.

Adjust the click volume here.

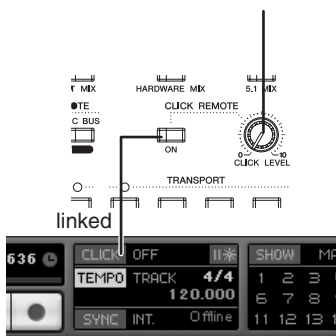

Turning the metronome on and off

Press the CLICK REMOTE [ON] switch to turn it on (the switch LED lights up).

Turning the metronome on or off on the n8/n12 will also turn the Cubase metronome on or off, and vice versa. For example, turning the Cubase metronome on will turn the CLICK REMOTE [ON] switch on.

Adjusting the metronome volume

Rotate the [CLICK LEVEL] knob. As you turn the knob clockwise, the volume of the metronome increases. If you

All WORK MODE switches turn off immediately after the mixer is connected to Cubase. When you press one of the switches to select a desired Work mode, the corresponding output destination is selected in Cubase, and the switch LED lights up. The following paragraphs describe each Work mode.

■ ST MIX

In this Work mode, all audio tracks are mixed in Cubase, then output to the n8/n12 DAW monitor channels (n12: L&R, n8: L&R).

To monitor the Cubase signals, turn on the DAW TO ST [ON] switch to add output signals from Cubase to the mixer's STEREO buses, then monitor the signals via the STEREO buses. If you wish to monitor only the output signals from Cubase, turn on the C-R SOURCE SELECT [DAW] switch.

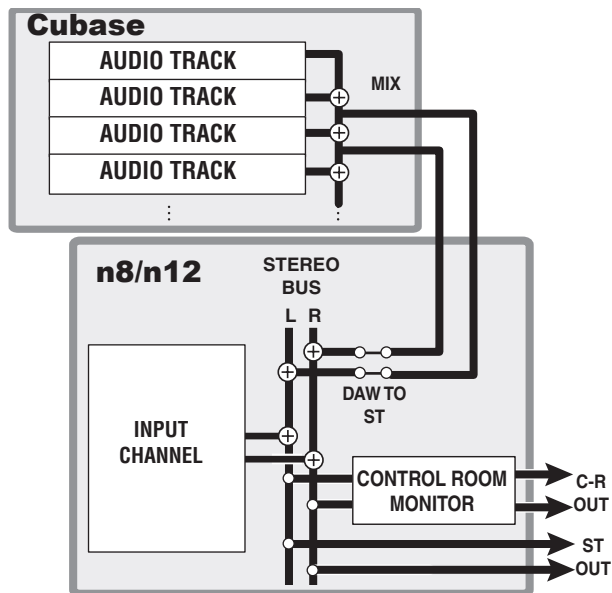

■ 5.1 MIX Only n12

In this mode, audio tracks are routed to the Cubase surround buses. The signals mixed to the surround buses can be monitored via the n12 Control Room monitor. For more information on surround monitoring, refer to page 48.

- NOTE**
- You cannot set Work mode to 5.1 MIX if you are using Cubase Studio 5/Cubase Studio 4/Cubase Essential 5/Cubase Essential 4/Cubase AI 5/Cubase AI 4 since neither application supports the surround environment.
 - Before you switch Work modes, you must first create I/O buses in Cubase so that audio data can be transferred between Cubase and the n8/n12. If you create a project using one of the n8/n12 project templates, the I/O buses will be created automatically. If you plan to create I/O buses manually, refer to the section "Bus connections of n8/n12 and DAW" on page 60.

■ HARDWARE MIX

In this Work mode, the output signal from each Cubase audio track is individually input to each n8/n12 input channel, then mixed and processed via the compressor or equalizer.

When this mode is selected, signals from the DAW (DAW inputs) will be sent to all the input channels, and the DAW LED in the INPUT SELECT switch area will light up.

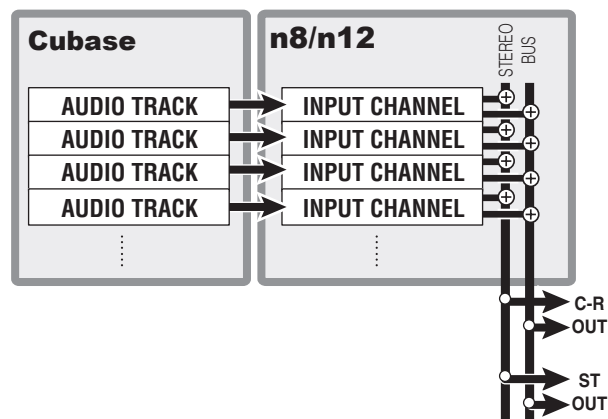

Setting up a musician's monitor

If the Work mode on the n8/n12 is set to ST MIX, Cubase audio tracks will be mixed in the Cubase mixer, then output to the n8/n12. If necessary, you can make another audio track mix independent from the main mix (the mix output to the n8/n12). This independent mix can be used as a musician's monitor.

To create a musician's mix, transfer Cubase audio track output directly to the n8/n12 AUX bus by using the Cubase mixer send.

In the n8/n12 project templates, each audio track send has already been assigned to the n8/n12 AUX bus. By adjusting the send level for each audio track in Cubase in the same way as when you create a musician's mix by using the n8/n12 [AUX] control, you can create a musician's mix.



If you create a new audio track, or if you create a project without using the n8/n12 project templates, assign the n8/n12 AUX buses to the audio track sends in Cubase.

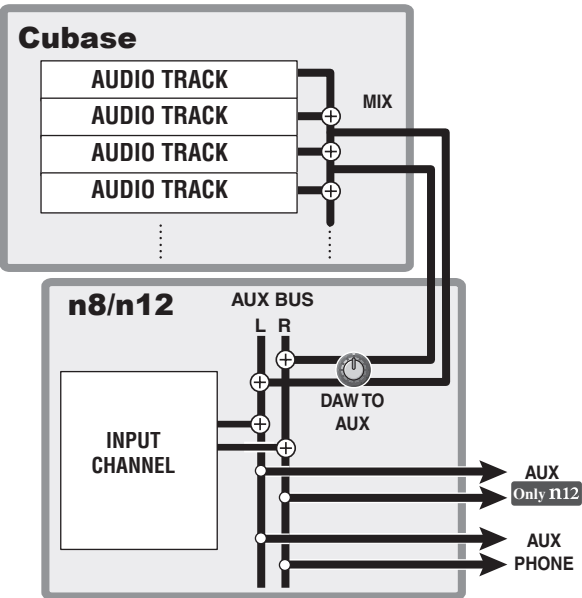

To transfer signals to the n8/n12 AUX buses from Cubase, "n12 (n8) AUX L/R" must be assigned to the device (audio) port for the output buses (that are assigned to the Cubase audio track sends). The assignments in the n8/n12 project templates are as follows:

Output bus	n12(n8)-AUX
Device (Audio) port	n12(n8) AUX L/R

You can adjust the volume of the entire monitoring signal either in Cubase or on the n8/n12.

You can use the [DAW TO AUX] control and the following controls to adjust the volume of the n8/n12's monitor signal.

For the n8

[AUX PHONES] control

For the n12

[AUX PHONES] control and [AUX LEVEL] control

NOTE If you are using Cubase 5/Cubase 4, disable the Control Room function of Cubase.

Let's start our recording session!

This section will help you understand how to transfer the n8/n12 input channel signals to Cubase and record them on the audio tracks.

You can do this in either of the following two ways:

Mixing signals on the n8/n12, then recording

The n8/n12 has a dedicated bus (REC bus) that can be used to record the mixer signals to a DAW, such as Cubase. Using this bus enables you to mix any input channel signals on the n8/n12, then record them in Cubase.

This example here uses the Monitor Remote function to monitor the VST effect signals while recording signals via the REC bus.

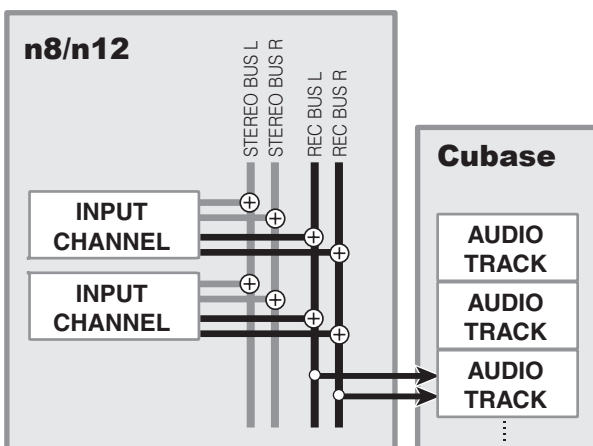

NOTE If you select the "Yamaha n12 (n8) stereo recording" project template, the REC bus will be automatically selected as the input source for each audio track.

■ Preparing for recording

1. Press the INPUT SELECT [A.IN] switch to turn it on (analog input).

While Cubase is linked to the mixer, you can select the input source by using the INPUT SELECT switches. While the INPUT SELECT [A. IN] switch is turned on, analog input can be selected as the input source. While the INPUT SELECT [DAW] is turned on, Cubase (DAW) output signal can be selected as the input source. Typically, you will select analog input for recording, and select DAW when you wish to mix the recorded signals in Cubase using the n8/n12.

2. Connect musical instruments and microphones to the mixer's input channels, then adjust the gain and pan.

For details, see "A Hands-On Guide to the n8/n12" on page 24 to 32.

3. Turn on the [REC] switches for the channels you wish to record. (The switch LEDs light up.)

If you turn on the channel [REC] switches, the corresponding input channel signals will be routed to the REC bus. At this time, the pan and volume balance of each input channel will be used.

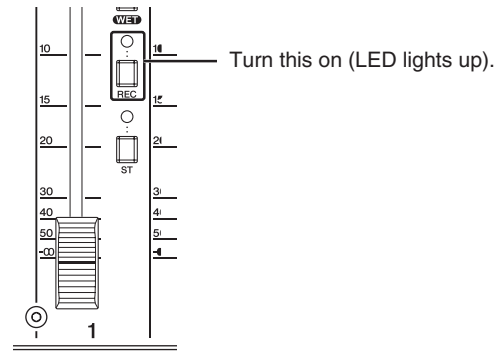

4. On Cubase, select the audio track on which you wish to record, and then select "n12 (n8)-REC" as the input routing by clicking it.

The input source and output destination of the track will be displayed in the Inspector located to the left of the track list. You can select the input source for the audio track by clicking an input routing option.

If you select "n12(n8)-REC," the REC bus signals will be input to the corresponding audio track.



input source of audio track
(Input Routing)

NOTE

- To select a track in Cubase, you can use the [PREV ▲] and [NEXT ▼] switches in the DAW Remote Control section on the n8/n12.
- If the track's input/output routing is not displayed, click the [Show Inspector] button.



Show Inspector

5. Make sure that the Record Enable button is on (red) for the recording destination audio track in Cubase. If it is off, press the [REC READY] switch in the DAW Remote Control section to turn on the Record Enable button.

The REC bus signals will be sent to the corresponding audio track. If you want to record the signals without any VST effect being applied, proceed to Step 10.



If you wish to turn on the Record Enable button for multiple tracks by using the [REC READY] switch, make the following settings in Cubase.

- (1) Open the [Preferences] dialog box by selecting [File] → [Preferences] (for Windows), or by selecting [Cubase] → [Preferences] (for Macintosh).
- (2) Select [Project & Mixer] from the [Editing] menu.
- (3) Remove the check from the “Enable Record on Selected Track” check box in the dialog box.
- (4) Click [OK] to close the dialog box.

Setting the Monitor Remote function

If you wish to monitor the REC bus signals processed by a VST effect, follow steps 6 to 9 below.

6. Make settings in Cubase to insert the VST effect on the input bus or audio track.
7. Turn the MONITOR REMOTE [ON] switch on (the switch LED lights up).
8. Turn the MONITOR REMOTE [REC BUS WET] switch on (the switch LED lights up).

The Monitor Remote function is activated. Turning the MONITOR REMOTE [REC BUS WET] switch on turns the Cubase monitoring button on as well. When the both switches are on, you can monitor the signal with the VST effect applied (the “wet” sound).

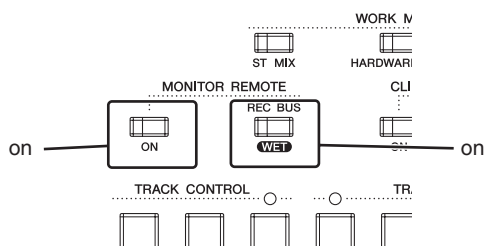

9. Turn the DAW TO ST [ON] switch on ().

While the Record Enable button and monitoring button are turned on, the REC bus monitoring signal will be returned to the n8/n12 via the Cubase mixer. When you turn the DAW TO ST [ON] switch on, the monitoring signal returned from Cubase will be routed to the STEREO buses, enabling you to monitor the signal.

While you are using the Monitor Remote function, the input channel signals being sent to the REC buses will temporarily be disconnected from the STEREO bus so that they will not be doubled in the monitor sound; this allows you to monitor the signal that is being routed through Cubase. While the Monitor Remote function is active, the corresponding input channel's [ST] switches flash. If you deactivate the Monitor Remote function, the [ST] switches stop flashing.

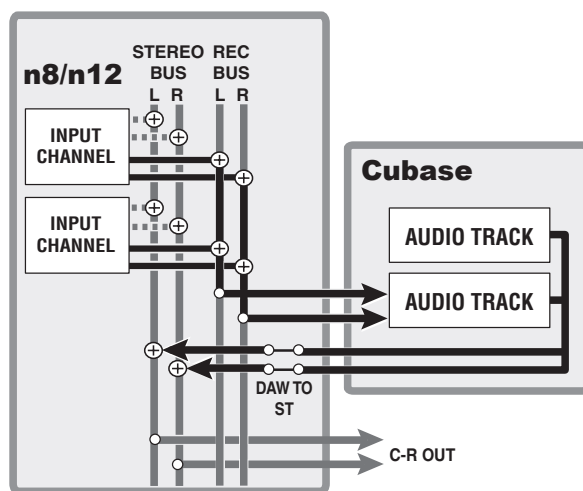

To activate the Monitor Remote function, first turn the Record Enable buttons on, then turn the MONITOR REMOTE [ON] switch and [REC BUS WET] switch on.

- NOTE**
- Processing the signals via the VST or other effects may cause latency in the monitoring signal.
 - While the Monitor Remote function is active, the effect signals will be directly routed to the AUX output. Therefore, the [AUX] control for the corresponding input channels will be disabled. If you wish to adjust the monitoring balance between the instruments, adjust the level in Cubase.

Recording

10. Press the [REC] switch to start recording.
11. Play the instruments.
12. When you finish playing the instruments, press the [■] switch to stop recording.
13. To review the recorded result, press the [◀◀] switch or [◀] switch to return to the beginning of the project, then press the [▶] switch.

Recording n8/n12 input channel signals directly to Cubase

Each input channel signal can be output and recorded to a Cubase audio track individually. This section will help you understand how to record a signal from input channel 1 directly to a Cubase audio track while using the Monitor Remote function to monitor the VST effect signals.

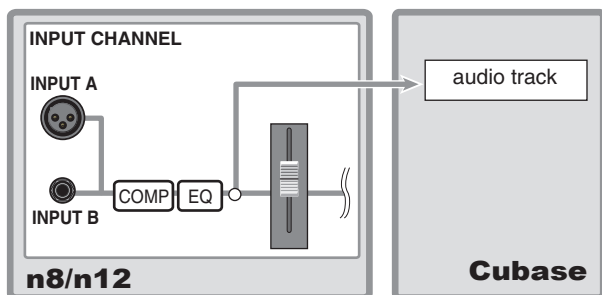

The pre-fader signal will be sent to the audio track. When using this method of recording (n8/n12 input channel signals directly to Cubase), the channel fader and other channel controls will be disabled.

■ Preparing for recording

1. Press the **INPUT SELECT [A.IN]** switch to turn it on (analog input).
2. Connect a musical instrument or a microphone to the mixer's input channel 1, then adjust the gain. For details, see "A Hands-On Guide to the n8/n12" on page 24 to 25.
3. Select an audio track on which you wish to record the signal, then select "n12(n8)-Dir1" for input routing by clicking it.

The input source and output destination of the track will be displayed in the Inspector located to the left of the track list.

If you select "n12(n8)-Dir1," the channel 1 signal will be input to the specified audio track.



input source of audio track (Input Routing)

NOTE If you select the "Yamaha n12 (n8) multi channel recording" project template, the direct output from the input channel will be automatically selected as the input source for each Cubase audio track.

- NOTE**
- To select a track in Cubase, you can use the [PREV ▲] and [NEXT ▼] switches in the DAW Remote Control section on the n8/n12.
 - If the track's input/output routing is not displayed, click the [Show Inspector] button.

You can select the input source from the following options:

■ n12

Input routing	Input source
n12-REC(Left/Right)	REC bus
n12-ST(Left/Right)	STEREO bus
n12-Dir1~n12-Dir8	Monaural input channel direct output
n12-Dir9/10, n12-Dir11/12 (Left/Right)	Stereo input channel direct output

* Options in parentheses can be selected only for monaural tracks.

■ n8

Input routing	Input source
n8-REC(Left/Right)	REC bus
n8-ST(Left/Right)	STEREO bus
n8-Dir1~n8-Dir4	Monaural input channel direct output
n8-Dir5/6, n8-Dir7/8 (Left/Right)	Stereo input channel direct output

* Options in parentheses can be selected only for monaural tracks.

4. Press the **[REC READY]** switch in the DAW Remote Control section; the **Record Enable button in Cubase will be turned on for the audio track on which you are recording.**

The REC bus signals will be sent to the specified audio track. If you want to record the signals without a VST effect being applied, proceed to Step 9.



■ Setting the Monitor Remote function

If you wish to apply a VST effect to the input channel 1 signal and monitor the effect signal, follow steps 5 to 7 below.

5. Insert the desired VST effect in the Cubase input bus to which input channel 1 is being sent, or insert it into the audio track.

6. Turn the MONITOR REMOTE [ON] switch on (the switch LED lights up).

When the MONITOR REMOTE [ON] switch is on, the Monitor Remote function is active.

7. Turn the input channel 1 [WET] switch on (the LED will light).

Turning the Input Channel [WET] switch on turns the Cubase monitoring button on as well. When the both switches are on, you can monitor the signal with the VST effect applied (the “wet” sound).



monitoring button

8. Turn the DAW TO ST [ON] switch on ().

While the Record Enable button and monitoring button are turned on, the monitoring signal will be returned to the n8/n12 via the Cubase mixer. When you turn the DAW TO ST [ON] switch on, the monitoring signal returned from Cubase will be routed to the STEREO buses, enabling you to monitor the signal.

If you wish to listen to the effect signal only in the control room, turn on the C-R SOURCE SELECT [DAW] switch to select DAW (Cubase) as the monitoring source.

If the input channel signal had been routed to the STEREO bus, the input channel signal being sent to Cubase will temporarily be disconnected from the STEREO bus so that it will not be doubled in the monitor sound. While the signals are disconnected, the corresponding input channel's [ST] switches flash. If you deactivate the Monitor Remote function, the [ST] switches stop flashing.

To activate the Monitor Remote function, first turn the Cubase Record Enable buttons on, then turn the MONITOR REMOTE [ON] switch and the Input Channel [WET] switches on.

NOTE

- If the [WET] switches for multiple input channels have been turned on, turning off the MONITOR REMOTE [ON] switch will turn off all channel [WET] switches.
- Processing the signals with VST effects may cause latency in the monitoring signal.
- While the monitor remote function is active, the signal with the VST effect applied will be sent directly to the AUX output. This means that the [AUX] control of the corresponding input channel will temporarily be disabled. If you want to adjust the monitor balance, you can do so within Cubase.

■ Recording

9. Press the [REC] switch to start recording.

10. Play the instrument.

11. When you finish playing the instrument, press the [■] switch to stop recording.

12. To review the recording result, press the [◀◀] switch or [▶] switch to return to the beginning of the project, then press the [▶▶] switch.

Mixing recorded tracks

You can easily monitor tracks recorded in Cubase by mixing them on Cubase and setting the n8/n12's C-R SOURCE SELECT switch to DAW. If you wish to use the n8/n12's compressor and reverb, you can mix tracks using the n8/n12. This section describes how to send recorded audio track data from Cubase to the n8/n12 input channels, and then mix them to stereo.

Mixing audio tracks

1. If the Monitor Remote function is active, turn the **MONITOR REMOTE [ON]** switch off to disable the Monitor Remote function.
2. If any audio tracks' Record Enable buttons are on, turn these buttons off.
3. Set the **STEREO** fader to the "0" position, then make sure that the **STEREO [ON]** switch is turned on.
4. Turn on the **[HARDWARE MIX]** switch in the DAW Remote Control section (the switch LED lights up). When the switch is turned on, the input source for all input channels is switched to DAW (Cubase audio tracks).

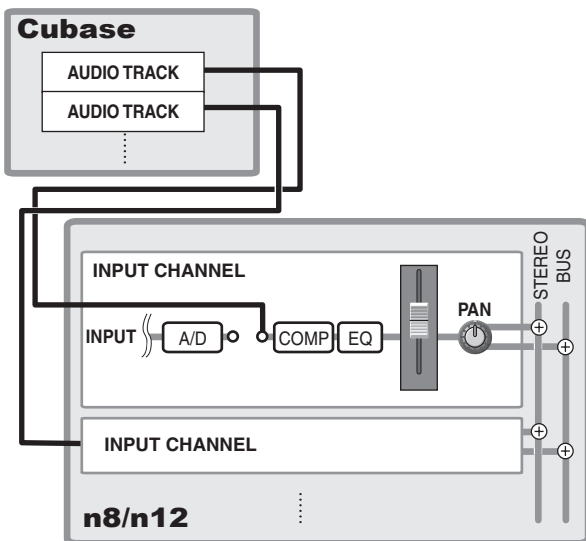

When you set the Work mode to HARDWARE MIX, the audio track outputs will be assigned to channels in the order of their track number.



■ n12

Cubase track #	Output to (n12 input channel)
Track 1	n12-1
Track 2	n12-2
Track 3	n12-3
Track 4	n12-4
Track 5	n12-5
Track 6	n12-6
Track 7	n12-7
Track 8	n12-8
Track 9	n12-9/10
Track 10 and higher	n12-11/12

■ n8

Cubase track #	Output to (n8 input channel)
Track 1	n8-1
Track 2	n8-2
Track 3	n8-3
Track 4	n8-4
Track 5	n8-5/6
Track 6 and higher	n8-7/8

NOTE While the Work mode is set to HARDWARE MIX, you can select analog inputs (A. IN) as the input source for the input channels. This is convenient if you wish to add analog input signals to the mix.

5. If necessary, click the audio track output routing menu, and change the output destination.



Use one of the following three methods to route Cubase audio tracks to the n8/n12.

■ **Assign each audio track to an input channel individually**

This method is useful when you want to mix a solo part or other important parts.

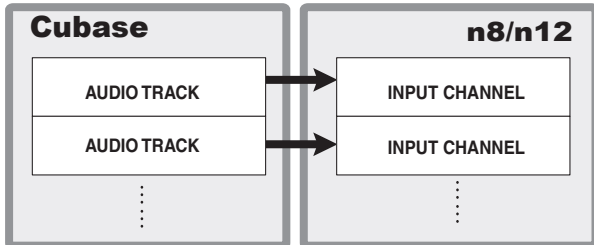

■ **Assign multiple audio tracks to the same input channel**

In this case, multiple audio tracks will be mixed in the Cubase mixer, then routed to the n8/n12 input channel.

This method is useful when you want to first create a mix from multiple tracks, such as drums recorded on multiple tracks.

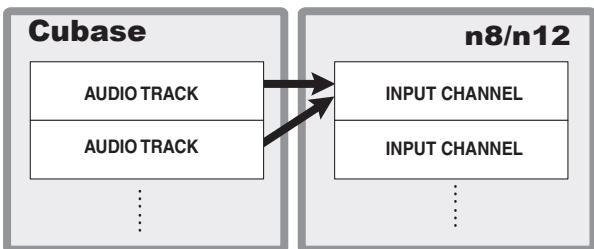

■ **Select the “n12 (n8)-L/R” output routing option, then mixing signals via DAW TO ST.**

If you turn the DAW TO ST [ON] switch on, you can use DAW TO ST as the input channel.

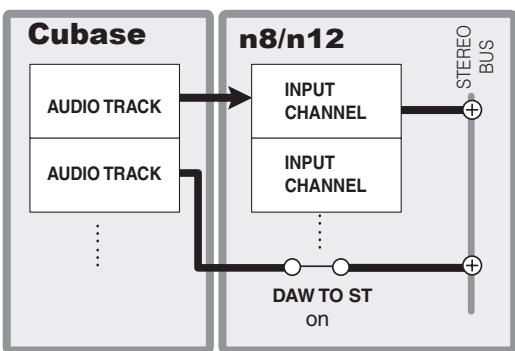

6. **Use the Cubase mixer control to adjust the output level of the audio tracks.**

■ **If you are assigning each audio track to an input channel individually:**

In the Cubase mixer, set the fader (for the track you wish to assign) to the “0.00” position. With this setting, the signal will be routed to the input channel at the nominal output level.

■ **If you are assigning multiple audio tracks to the same input channel:**

In the Cubase mixer, adjust the mix balance between the tracks.

7. **While playing back the Cubase project, control the channel faders to adjust the mix balance.**

If the signals are being mixed to the STEREO buses via DAW TO ST, rotate the DAW TO ST [LEVEL] control to adjust the signal level.

You can also apply the n8/n12 built-in digital reverb to the audio track playback signal by turning on the REVERB TO ST [ON] switch and rotating the channel [REVERB] control.

Mixing down

Finally, mixdown time! Now you can record the completed mix onto stereo tracks. This section explains how to do so.

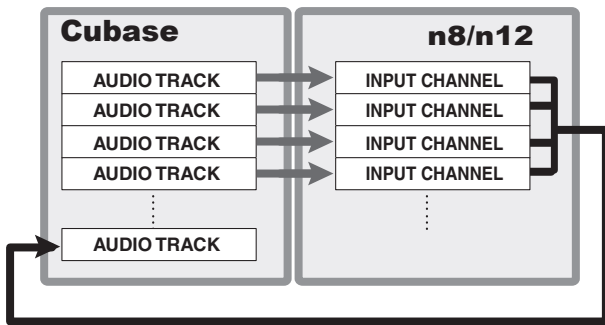

1. Select [Project] → [Add tracks] → [Audio].
The Add Audio Track dialog box opens.

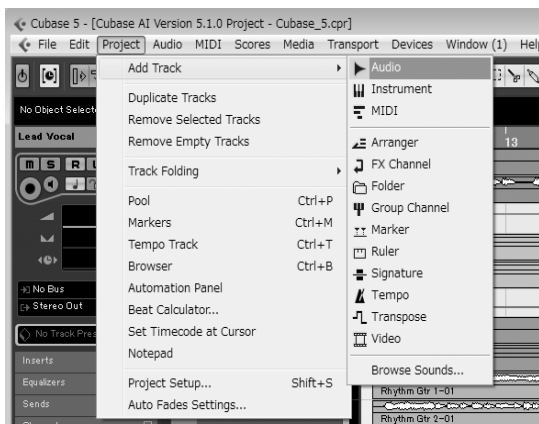

2. Click the Configuration column to select “stereo,” then click [OK].

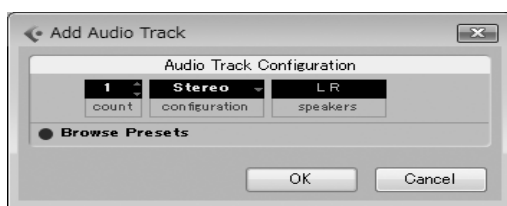

A new stereo track is created.

3. Select the created stereo track, then turn the Record Enable button on.
4. Click the input routing option to select “n12 (n8)-ST.”
The STEREO bus signal of the n8/n12 will be input to the new stereo track in Cubase.

5. If the Cubase track outputs are routed to the n8/n12 STEREO buses via DAW TO ST, turn off the DAW TO ST [ON] switch.

If the DAW TO ST [ON] switch is on during mixdown, an audio loop will be created, producing a very loud noise. Be sure to turn off the DAW TO ST [ON] switch before you start mixdown.

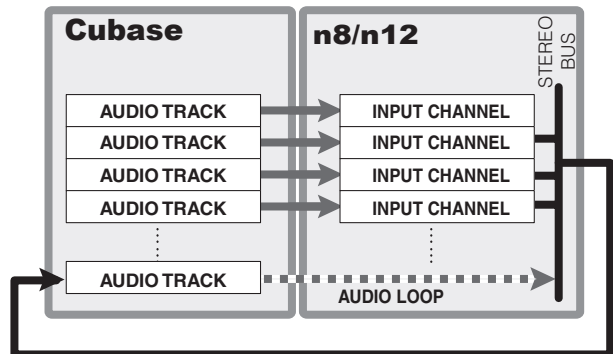

6. Press the [I<] switch or the [◀◀] switch to locate the top of the project.

7. Press the [REC] switch to start mixdown.
The project starts playing from the beginning, and the signals being mixed on the n8/n12 in real time will be recorded to the new stereo track.



mixdown tracks

8. When you have finished recording, press the [■] switch to stop the playback.
9. To review the recording, click the solo state button to turn it on, then use the [◀◀] or [I<] switch to return to the beginning of the project, then press the [▶] switch to listen to the recording.

Monitoring in a Surround Sound Environment (n12 only)

The n12 features a Surround Monitor function that enables you to easily monitor your 5.1-channel surround mix in Cubase 5. This section describes how to use the Surround Monitor function.

NOTE Cubase 5/Cubase 4 is required in order to use the surround monitor functionality. The included Cubase AI does not support surround monitoring, and cannot use the surround monitor functionality.

Connecting surround speakers

Connect each surround channel speaker to C-R OUT jacks A-C. Each jack is assigned to the following channel speaker:

- C-R OUT jack A (L)L channel speaker
- C-R OUT jack A (R)R channel speaker
- C-R OUT jack B (L) Center channel speaker
- C-R OUT jack B (R) Subwoofer
- C-R OUT jack C (L)L surround channel speaker
- C-R OUT jack C (R)R surround channel speaker

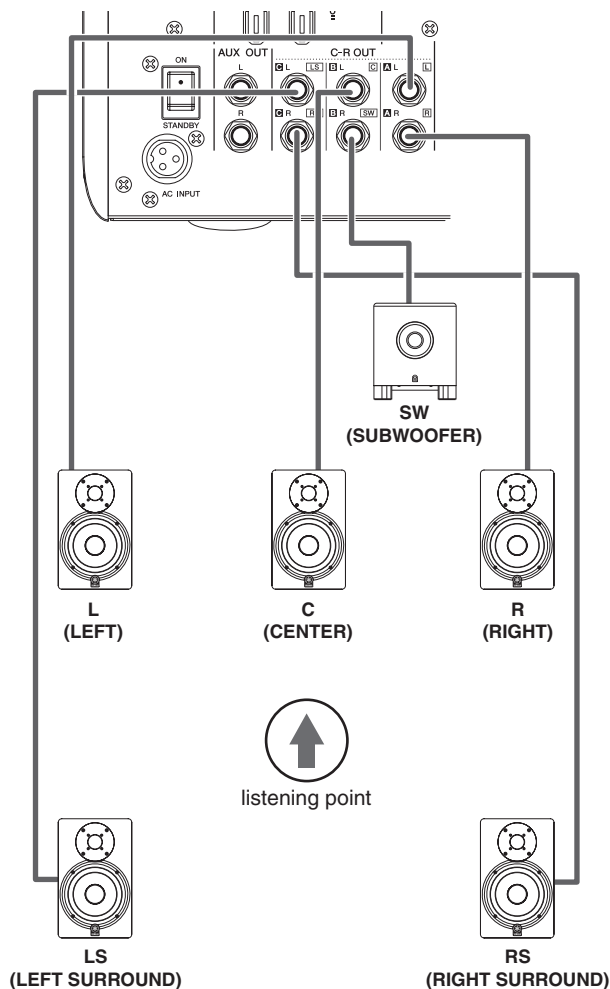

Placement of the surround speakers

Speaker position is extremely important to accurate monitoring in a surround sound environment. Refer to the description below to place your speakers.

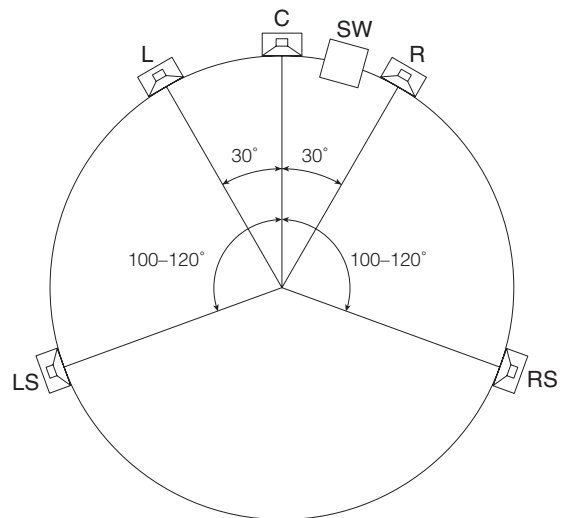

L/R channel speakers

Place your L & R speakers so that they form an equilateral triangle, with your listening position as the third point. (All three sides should be the same length, and all three interior angles should be 60°).

LS/RS channel speakers

Place your LS & RS speakers so that they are in about the 4 o'clock and 8 o'clock positions (100 - 120° angle from the center.)

Center channel speaker

Determining where to place the center channel speaker is easy. Simply place it between the L and R channel speakers. If possible, place it slightly further away from the listening position than the L and R channel speakers. In other words, if you were to draw a line between the L and R speakers, the center speaker should be positioned a little beyond that line.

Subwoofer (LFE channel)

Place your subwoofer the same distance from the listening position as the other speakers, and on the floor between the L and R channel speakers. Since a subwoofer typically features a wide projection angle, shifting its position to the left or right will not affect the sound you hear.

English

Setting up surround monitoring

1. Turn on the [5.1 MIX] switch in the DAW Remote Control section (the switch LED lights up).

The n12 switches Work mode to 5.1-ch surround. Cubase selects “n12-5.1” as the destination of its audio tracks.

NOTE For more information on surround mixing using Cubase, please refer to the Cubase Owner’s Manual.

2. Turn on the [5.1] switch in the Control Room section (the switch LED lights up).

5.1-ch Cubase signals will be adjusted by the Bass Management function, then input to the Control Room Monitor section, and output to the speakers. You can adjust the monitoring level using the [CONTROL ROOM LEVEL] control.

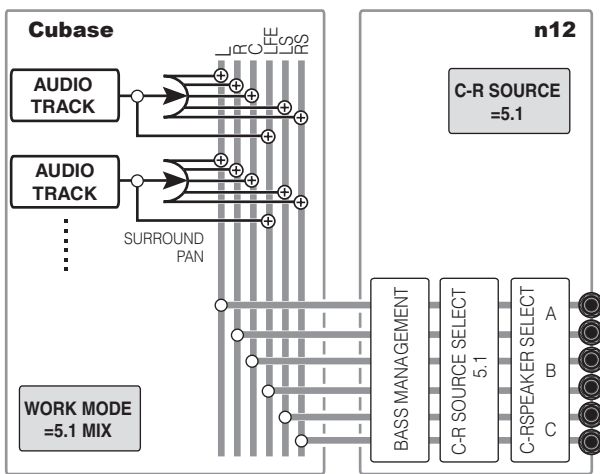

3. If you wish to mute certain surround channel signals, press the corresponding C-R SPEAKER SELECT switches.

Pressing any C-R SPEAKER SELECT switch during surround monitoring will mute the corresponding surround channel. Pressing any C-R SPEAKER SELECT repeatedly will cycle the corresponding switch LED status as follows: lights up solid → flashing fast → flashing slow → off. The following table can help you select the channel you wish to mute.

	Lit	Flash (fast)	Flash (slow)	Off
C-R SPEAKER SELECT [A] switch	L & R: output	L: output R: mute	L: mute R: output	L & R: mute
C-R SPEAKER SELECT [B] switch	C & SW: output	C: output SW: mute	C: mute SW: output	C & SW: mute
C-R SPEAKER SELECT [C] switch	Ls & Rs: output	Ls: output Rs: mute	Ls: mute Rs: output	Ls & Rs: mute

4. To cancel surround monitoring, use the C-R SOURCE SELECT switches to select any monitor source other than 5.1 channel.

Bass Management function

In a surround sound system that includes a subwoofer, the bass components of all channels and the LFE channel signal are output to the subwoofer. Bass Management is a function that makes adjustments in order to prevent interference between the signals sent to the subwoofer and the signals sent to the other speakers.

While you are using the n12 Surround Monitor function, the Bass Management function works as illustrated in the diagram below.

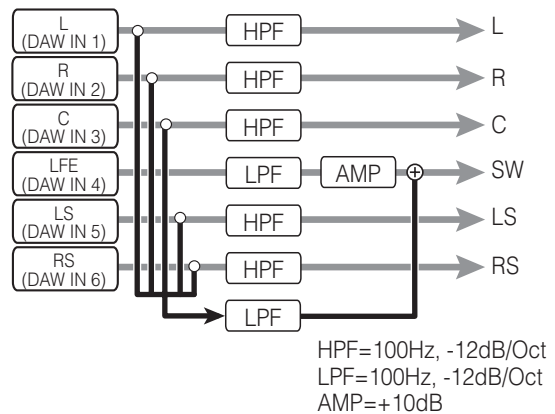

Surround downmix

If necessary, you can monitor the sound in stereo by mixing the surround signals into two channels during surround monitoring. This is called a “surround downmix.”

To downmix the signals during surround monitoring, turn on the [DOWN MIX] switch in the Control Room section. The LS, RS, C, and LFE channel signals will be split to L and R channels, then output from the C-R OUT jack A. Meanwhile, the level of these channel signals will be automatically adjusted so that the monitoring level will not change. Press the [DOWN MIX] switch again to cancel the downmix and restore the surround signals.

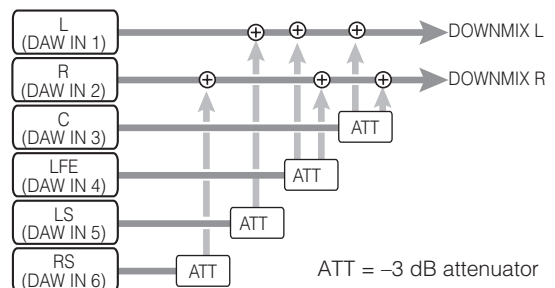

- NOTE**
- During surround monitoring, the C-R PHONES jack always output downmix signals.
 - You can turn on the [5.1] switch and the [ST] switch in the Control Room section simultaneously. In this way, you can mix together the surround L and R channel signals and the L and R signals in the STEREO buss, then output them to the monitor speakers. If the DAW TO ST [ON] switch has been turned on, turning on the [5.1] and [ST] switches together at the same time will turn off the [ON] switch (the switch LED flashes).

Replacing the Sweet Spot Data

You can replace the n8/n12's compressor settings (Sweet Spot Data) by using a dedicated software application called Sweet Spot Data Manager. This application contains several Sweet Spot Data sets and enables you to easily replace (load) the data while the n8/n12 is operating. For example, you can apply compression using the preset data while recording, and use other data while mixing.

Download the Sweet Spot Data Manager from the following URL.

<http://www.yamahasyth.com/download/>

Double-click the Sweet Spot Data Manager icon, and install the program as directed in the screen. For details on the installation, refer to the installation guide included with the application.

Follow the steps below to load the Sweet Spot data on your n8/n12.

1. Make sure that the n8/n12 is connected to a computer via an IEEE 1394 cable, and is operating normally.

NOTE Before using the Sweet Spot Data Manager, make sure that the n8/n12 is connected to a computer correctly, and that the application software, including the driver software, has been installed correctly.

- To avoid malfunction, connect the n8/n12 to a computer directly, without any other devices connected to either machine.

2. Start Sweet Spot Data Manager.

Windows:

From the Start menu, select [All Programs] → [Sweet Spot Data Manager] to start the application. Alternatively, double-click the Sweet Spot Data Manager short-cut icon on the desktop.

Macintosh:

Double click [Applications] → [Yamaha] → [SweetSpotDataManager] → [SSDManager] to start the application. When the application starts up, the following screen will appear.

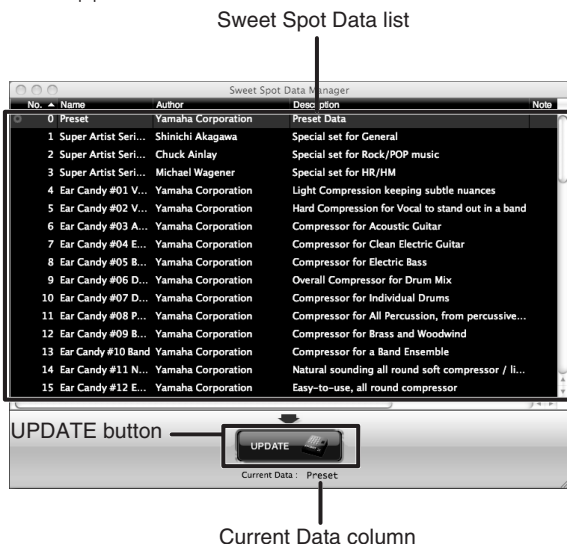

3. In the Sweet Spot Data list, click the name of a Sweet Spot Data set that you wish to load on the n8/n12.

You can sort the list by No, Name, Author, Description or Note by clicking the corresponding column title.

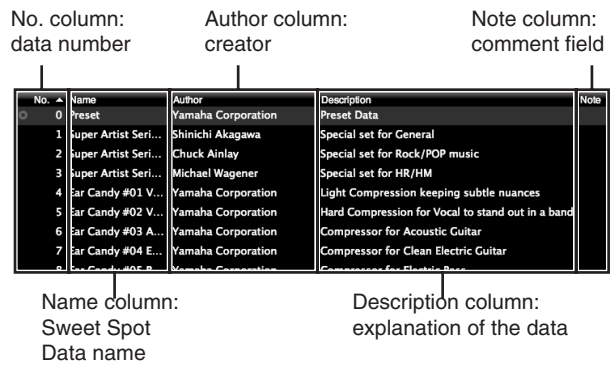

NOTE You can enter comments in the Note column. For example, if you enter a number in the Note column for each data, you can sort the list by number by clicking the column entitled Note.

4. To load the selected data on the n8/n12, click the UPDATE button.

It takes only a few seconds to load the data. When the load operation is complete, you can use the new Sweet Spot data immediately.

NOTE During the load operation, the n8/n12 output signals will be muted.

To return the Sweet Spot data to the factory-set state, select "0 Preset" in the Sweet Spot Data list and click the UPDATE button.

If the n8/n12 is connected to a computer correctly, the UPDATE button will be highlighted in color. The current, loaded data on the n8/n12 will be listed in the Current Data column.

NOTE If an error message is displayed, check that the cable is correctly connected, and that the driver and other required software is installed correctly. Then restart the application.

Using the n8/n12 with Software Other Than Cubase

You can use the n8/n12 with other DAWs in addition to Cubase, as well as multimedia applications such as Windows Media Player. To do so, follow the procedure below:

NOTE A dedicated driver (Yamaha Steinberg FW Driver) must already be installed and set up properly.

Using the n8/n12 with a DAW other than Cubase

If you are using a typical DAW (other than Cubase), you will be able to do the following.

- **Input and output audio signals**
- **Input and output MIDI messages**
- **Use remote control to operate the DAW**

NOTE For information on setting up your DAW, refer to the DAW owner's manual.

Audio Driver Setup

Input and output audio signals

The signals from the n8/n12 can be recorded on the audio tracks of your DAW, and the audio tracks' playback signals can be mixed on the n8/n12. Select "Yamaha Steinberg FW ASIO"/"Yamaha Steinberg FW WDM Audio" (for Windows) or "Yamaha Steinberg FW" (for Macintosh) on the audio driver setup window for your DAW software, then set the n8/n12 audio input/output ports as follows.

● SONAR 8 (with ASIO driver)

	DAW → n8/n12	n8/n12 → DAW
n12	Yamaha Steinberg FW ASIO n12 Monitor L-Yamaha Steinberg FW ASIO n12 AUX L	Yamaha Steinberg FW ASIO n12 Direct Out 1-Yamaha Steinberg FW ASIO n12 ST Bus L
n8	Yamaha Steinberg FW ASIO n8 Monitor L-Yamaha Steinberg FW ASIO n8 AUX L	Yamaha Steinberg FW ASIO n8 Direct Out 1-Yamaha Steinberg FW ASIO n8 ST Bus L

● SONAR 8 (with WDM/KS driver)

	DAW → n8/n12	n8/n12 → DAW
n12	Yamaha Steinberg FW WDM Audio 1/2- Yamaha Steinberg FW WDM Audio 5/6	Yamaha Steinberg FW WDM Audio
n8	Yamaha Steinberg FW WDM Audio 1/2- Yamaha Steinberg FW WDM Audio 5/6	Yamaha Steinberg FW WDM Audio

NOTE If you are using the WDM/KS driver, six channels can be output and two channels can be input from your DAW to the n8/n12.

● Logic Pro 8

	DAW → n8/n12	n8/n12 → DAW
n12	Output 1–Output 16	Input 1–Input 16

● Logic Pro 8

	DAW → n8/n12	n8/n12 → DAW
n8	Output 1–Output 12	Input 1–Input 12

● D.P.6

	DAW → n8/n12	n8/n12 → DAW
n12	Yamaha Steinberg FW:n12 Monitor L 1-Yamaha Steinberg FW:n12 AUX R 16	Yamaha Steinberg FW:n12 Direct Out 1 1-Yamaha Steinberg FW:n12 ST Bus R 16
n8	Yamaha Steinberg FW:n8 Monitor L 1-Yamaha Steinberg FW:n8 AUX R 12	Yamaha Steinberg FW:n8 Direct Out 1 1-Yamaha Steinberg FW:n8 ST Bus R 12

MIDI Driver Setup

NOTE If you are using D.P.6, you will need to connect the MIDI drivers to the MIDI input/output plugs of external devices from the "Audio MIDI Setup" window. Refer to page 50.

Input and output MIDI messages

DAW software displays the MIDI I/O connectors on the rear panel of the n8/n12 as follows:

MIDI ports that correspond to the n8/n12 MIDI I/O connectors		
Windows	Input	n8 MIDI IN (n8) n12 MIDI IN (n12)
	Output	n8 MIDI IN (n8) n12 MIDI IN (n12)
Macintosh	Input	MIDI IN
	Output	MIDI OUT

Remote control of the DAW

You can use the switches in the DAW Remote Control section (as shown below) to remotely control DAWs other than Cubase.

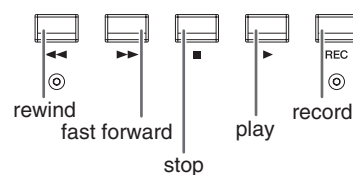

NOTE The Mackie Control "USER SWITCH (A)" function is assigned to the foot switch. If you prefer, you can assign another function to the foot switch from the DAW.

To remotely control your DAW from the n8/n12, make the following settings in the DAW:

Type of remote controller		
Mackie Control		
MIDI ports used for connecting the remote controller		
Windows	Input	n8 Remote (n8) n12 Remote (n12)
	Output	n8 Remote (n8) n12 Remote (n12)
Macintosh	Input	Remote
	Output	Remote

NOTE Logic Pro automatically recognizes it as the Mackie Control settings when the n8/n12 is connected to your computer.

For Digital Performer Users

To input and output the MIDI signals with D.P.6, you will need to set the MIDI driver.

1. Select [Application] → [Utilities] → [Audio MIDI Setup] to display the “Audio MIDI Setup” window. On Mac OS X 10.6, then select [Window] → [Show MIDI Window] to display the “MIDI Studio” window.
The MIDI driver is shown as “n8” or “n12.”

2. Click [Add Device] twice to add two external devices.

3. Connect the input/output plugs for the MIDI driver to those for the new external devices.

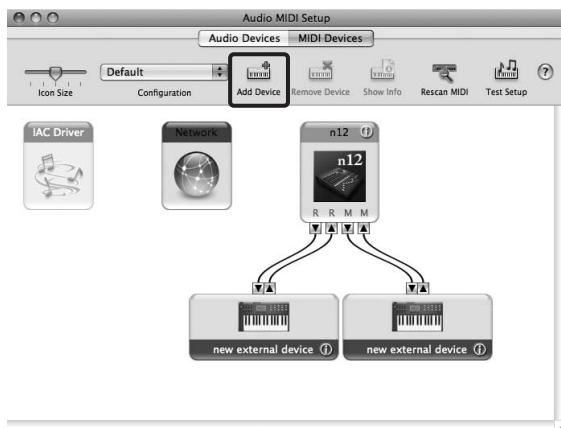

NOTE This setting may be unnecessary for the latest version of your DAW software.

Using the n8/n12 along with a multimedia application

To use the n8/n12 with a multimedia player such as Windows Media Player or Quick Time Player, you must make the following settings:

■ Windows:

1. From the Start menu, select [Settings] → [Control Panel] → [Sounds and Audio Devices]

The Sounds and Audio Devices dialog opens.

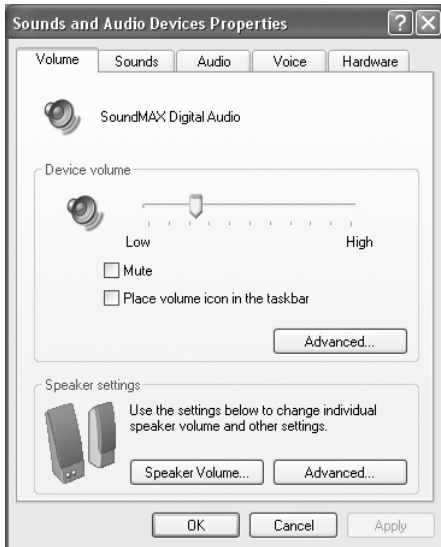

Click the Audio tab in the dialog, then select “Yamaha Steinberg FW WDM Audio” as the Default device for the Sound Playback column.



NOTE For Windows Vista/7, select [Start] → [Control Panel] → [Sound] → [Playback] → [Line Out Yamaha Steinberg FW WDM Audio], then click [Set Default].

2. Click [Apply] to apply the settings, then click [OK] to close the dialog.
3. Turn on the C-R SOURCE SELECT [DAW] switch on the n8/n12, then adjust the monitoring level for the control room.

■ Macintosh:

1. From the Apple menu, select [System Preferences...] to display the “System Preferences” window.
2. Click [Sound] on the window.
3. Click [Output], then select “Yamaha Steinberg FW” in the “Choose a device for sound output” field.

After you select “Yamaha Steinberg FW”, close the window.

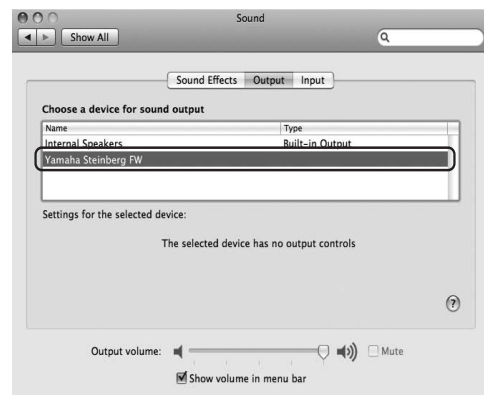

4. Select [Applications] → [Utilities] → [Audio MIDI Setup] to display the “Audio MIDI Setup” window.
5. Click [Audio Devices] and check whether “Yamaha Steinberg FW” is selected for “Default Output:” and “Properties For:.” Then, click [Configure Speakers].

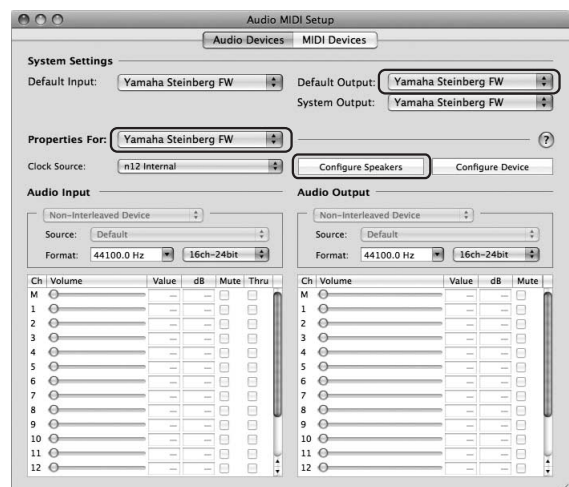

6. Select [Stereo], then click [Apply].

After making the setting, click [Done] and close the “Audio MIDI Setup” window.

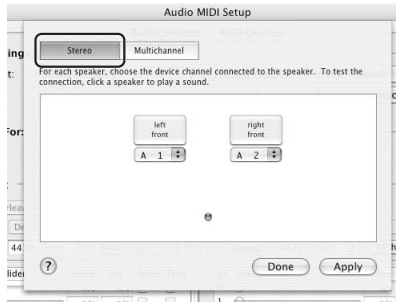
**7. Turn on the C-R SOURCE SELECT [DAW] switch on the n8/n12, then adjust the monitoring level for the control room.**

NOTE For more information on how to set up playback software, such as Windows Media Player, refer to the owner’s manual for the software or to its on-line help.

Surround monitoring Only n12

If your computer has software that is capable of 5.1 surround playback (such as a DVD player application), you can monitor 5.1-ch surround signals by connecting surround monitor speakers to the n12.

1. In the software you are using, select 5.1-ch surround as audio output.

For more information on how to set up the software, refer to the owner’s manual or on-line help for the software application.

2. Turn on the C-R SOURCE SELECT [5.1] switch on the n12 to adjust the monitoring level for the control room.

- NOTE**
- For Windows XP, follow the procedure below.
 - From the Start menu, select [Settings] → [Control Panel] → [Sounds and Audio Devices]. The Sounds and Audio Devices dialog opens.
 - Click the Audio tab in the dialog, then select “Yamaha Steinberg FW WDM Audio” as the default device in the Sound Playback column.
 - Click Advanced in the Sound Playback column to display the Advanced Audio Properties.
 - Click the Speakers tab, then select “5.1 surround sound speakers.”



Click [OK] to close the dialog.

- If you are using Windows Media Player, you must purchase a surround decode plug-in. For more information regarding purchasing and setting the decode plug-in, contact the manufacturer of the software you are using.

Troubleshooting

While using the mixer

■ No sound is heard, or the sound is too faint.

- The cable that connects the mixer and the external device may be damaged.
- Make sure that a signal from an external device or the DAW is being sent to the n8/n12's input.
- The volume of all connected tone generators and playback devices must be set to an appropriate level.
- The gain must be set to an appropriate level.
- If you are connecting a condenser microphone, the Phantom [+48V] switch must be turned on.
- If you are connecting an electric guitar, make sure that it is connected to an input jack that supports Hi-Z, and that the [Hi-Z] switch is turned on.
- Make sure that the INSERT I/O connectors are connected properly.
- Make sure that each channel [ON] switch is turned on.
- Is the [ST] switch of each channel turned on (assignment to the STEREO bus = enabled)?
- Each input channel fader must be raised to an appropriate level.
- The [CONTROL ROOM LEVEL] knob and the [C-R PHONES] knob must be set to an appropriate level.
- Make sure that the speakers or headphones are connected correctly.
- Make sure that the power to your amplifier and other external devices is turned on.
- Make sure that the volume between monitor speakers is well-balanced.

■ Sound is distorted.

- The cable that connects the mixer and the external device may be damaged.
- Make sure that audio was recorded at an appropriate level.
- The gain must be set to an appropriate level.
- If high-level signals are being input, the corresponding channel [PAD] switches must be turned on.
- The [Drive] control for the compressor may be set excessively high. Set the control to an appropriate level.
- The EQ gain may be set excessively high. Set the control to an appropriate level.
- The faders for an input channel, stereo input channel, or stereo output channel may be raised excessively. Set all faders to an appropriate level.

■ Noise.

- There may be a noise-producing device (such as a device containing a power inverter, etc.) near the cables. Move all cables away from any possible sources of noise.

■ Cannot use the built-in digital reverb.

- Be sure to adjust the input channel [REVERB] control to send the signal to the built-in digital reverb.
- Make sure that the output from the digital reverb is appropriately assigned.
- The REVERB [LEVEL] control must not be set to "0."

While using the mixer with a computer

■ If an error message appears:

- Refer to the "Error Messages" on page 55.

■ No sound is heard, or the sound is too faint.

- The volume settings within your application must be set to appropriate levels.
- Confirm whether or not the settings in Yamaha Steinberg FW Driver are appropriate. For details, refer to "Audio and MIDI signals fail to transfer between computer and mixer."

■ The sound is distorted.

- Make sure that audio was recorded at an appropriate level.

■ Noise is heard in the computer audio

- The IEEE 1394 cable may be damaged. Cables that do not satisfy IEEE1394 (S400) standards may cause noise.

- There may be a noise-producing device (such as a device containing a power inverter, etc.) near the IEEE1394 cable. Move all cables away from any possible sources of noise.
- Make sure that the appropriate number of devices is connected to the computer. Connection of too many devices may cause noise, depending on the capacity of the computer.
- Make sure your computer satisfies the system requirements.
- Make sure that the latency setting of the Yamaha Steinberg FW Driver is appropriate.
- Make sure that the sampling frequency is appropriate. A high sampling frequency may be the cause of noise, depending on the computer's capacity and speed.
- If your computer's hard disk is slow, problems may occur during recording and playback.
- Try increasing the computer's memory capacity.

- Quit all applications that are running in the background, when you use the n8/n12 with the computer. If such software is running, driver operation may become unstable and create noise. If you do not plan to use the n8/n12, you can turn these applications on again.
- (Windows) Some Intel mobile CPUs feature SpeedStep™ technology. If you are using the n8/n12 along with such a computer, disable the SpeedStep™ technology function. Most computers allow you to disable this in the BIOS. For more information, refer to the owner's manual for the computer, or contact the manufacturer of the computer.
- (Windows) Some network adaptors can cause noise. In such a case, use the Device Manager to disable the suspected network adaptor to remove the noise.

■ **The CUBASE READY indicator does not turn on. / Cubase cannot be remotely controlled.**

- Make sure that the n Extension software has been installed properly.
- Make sure that the n8/n12 is connected to the computer via an IEEE 1394 cable.
- You must use Cubase 5, Cubase 4, Cubase Studio 5, Cubase Studio 4, Cubase Essential 5, Cubase Essential 4, Cubase AI 5, or Cubase AI 4. Cubase SX3 and Cubase versions older than version 4 do not support the Link function.
- From the Devices menu, select Device settings to open the Cubase Device Settings panel, then make sure that "Yamaha n 12 (n8)" has been registered as a remote device. Also, make sure that "n12 (n8) Remote" has been selected as the MIDI I/O ports.
- (Macintosh) When an external MIDI device is added to the device "n8" or "n12" in the Audio MIDI Setup window (called up by selecting [Application] → [Utilities]), the MIDI input/output port for the remote device may not be set automatically in Cubase. In this case, remove all the external devices in the Audio MIDI Setup window, or manually set the MIDI input/output port for the remote device to the appropriate one in the Device Setup window in Cubase.

■ **The [WET] switch does not respond. / Cannot monitor wet (effect) signals.**

- Make sure that the CUBASE READY indicator is lit. If it is not lit, refer to the section "The CUBASE READY indicator does not turn on" above.
- Cubase projects must have an audio bus or track to be monitored. Create a bus or track manually, or use one of the n8/n12 project templates (see page 35).

■ **Pressing a WORK MODE switch does not change the output destination of Cubase audio tracks.**

- Make sure that the CUBASE READY indicator is lit. If it is not lit, refer to the section "The CUBASE READY indicator does not turn on" above.
- Cubase projects must have an audio bus or track to be monitored. Create a bus or track manually, or use an n8/n12 project template (see page 35).

■ **Cannot find a n8/n12 project template.**

- Make sure that the n Extension software has been installed.

■ **The computer processing speed is too slow.**

■ **The computer's CPU meter indicates a heavy processing load.**

■ **Playback response is delayed.**

■ **Insufficient tracks for recording or playback.**

- Make sure that the appropriate number of devices is connected to the computer. Try reducing the number of devices connected to the computer.
- Make sure that your computer satisfies the system requirements.
- Try increasing the latency value of the Yamaha Steinberg FW Driver.
- (Windows) Refer to "Hints when using audio data" in the TOOLS for n Version2/Cubase AI Installation Guide.

■ **An application, such as a DAW, fails to recognize the devices.**

■ **Audio and MIDI signals fail to transfer between computer and mixer.**

- Make sure that the IEEE 1394 cable is connected properly, and that the power to the n8/n12 has been turned on. Disconnect the IEEE1394 cable once, then insert it again.
- There may be a loop connection. Check the cabling to make sure that none of the devices are connected in a loop.

Example of loop connection

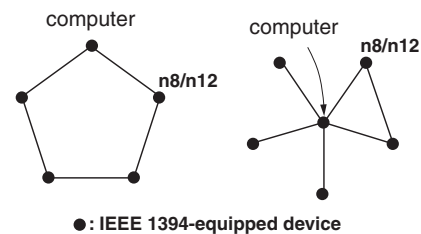

- When multiple devices compatible with the Yamaha Steinberg FW Driver are daisy-chain connected, remember that up to three devices can be connected if the Sample Rate is set to 44.1kHz/48kHz and up to two devices can be connected if the Sample Rate is set to 88.2kHz/96kHz. If more devices than this limit are connected, remove unnecessary device(s) from the daisy-chain connection.
- Confirm whether or not an audio device which is not compatible with the Yamaha Steinberg FW Driver has been connected. If so, remove the corresponding device from the daisy-chain connection.
- If any IEEE1394 devices which are not compatible with Yamaha Steinberg FW Driver are connected directly to a computer, disconnect them from the computer and make sure to connect only an n8/n12.

- There may be multiple IEEE1394 interfaces installed on the computer and each of the multiple IEEE1394 devices may be connected to different interfaces. When using multiple devices compatible with the Yamaha Steinberg FW Driver and connecting them to the computer peer-to-peer individually (i.e., star-connection), make sure to connect them all to the jacks of a single interface.
- Confirm whether or not “TOOLS for n Version2” has been installed correctly.
- (Windows XP) “Add New Hardware Wizard” may not be completed correctly. If you have canceled it, restart the computer so that “Add New Hardware Wizard” appears.
- Restart the computer.
- (Macintosh) If the new IEEE1394 interface (PC card, etc.) is connected to the computer (with the power turned on), restart the computer. The IEEE1394 device compatible with the Yamaha Steinberg FW Driver will be recognized by the computer after restarting.
- (Windows) Confirm whether or not the n Driver, AI Driver or mLAN Driver/mLAN Tools is installed to the computer. If so, disable these drivers.
- **Unable to transfer MIDI data or Program Changes.**
 - Confirm whether or not the appropriate MIDI port is selected in the application software (DAW, etc.).
 - Make sure the transmission and receive channels match between both the source device and destination device including the DAW software.
 - Confirm whether or not the MIDI settings have been properly made in the connected devices including the DAW.
 - Confirm whether the power of all connected devices has been are turned on or not.
- **Cannot use other connected Firewire devices correctly.**
 - Disconnect the IEEE1394 device compatible with the Yamaha Steinberg FW Driver from the computer.

Error Messages

Error message	Cause	Solution
Failed to initialize.	Initialization of Yamaha Steinberg FW Driver has failed.	Restart the computer.
(Software name) (Version) is installed. Yamaha Steinberg FW Driver cannot work with this version. Please update it to V1.6.3 or later.	(Windows only) The version of n Driver, AI Driver and mLAN Driver/mLAN Tools installed to your computer may not be compatible with the Yamaha Steinberg FW Driver.	Uninstall the n Driver or AI Driver installed to your computer. Update the mLAN Driver/mLAN Tools to V1.6.3 or later.
Failed to open Control Panel.	The Yamaha Steinberg FW Driver does not work properly.	Try the following operations. · Restart the computer. · Uninstall then install TOOLS for n Version2
Failed to change driver setting due to another processing.	The settings on the Control Panel cannot be accepted because another program is now changing the settings of the Yamaha Steinberg FW Driver.	Perform the settings again after a while.
Failed to change driver setting.	Failed due to a cause other than the above.	Disconnect the IEEE1394 cable from the device then connect again or turn off the power to that device then turn on the power again. If the problem persists, restart the computer.
	Insufficient memory space.	Exit all unnecessary applications and uninstall the unnecessary drivers.

Index

Numerics

- 2TR IN 20
- 2TR TO ST 16
- 5.1 18, 25
- 5.1 MIX 19, 37

A

- A.IN 14, 24
- ASIO driver 49
- AUX BUS 12, 14, 16
- AUX LEVEL 17
- AUX OUT 21
- AUX PHONES 17

B

- BAL 14
- Balanced 9
- Block Diagram 64
- Bus 11

C

- Channel fader 11, 15
- CLICK REMOTE 19, 36
- Click sound 36
- COMP LED 14
- Compressor 11, 14, 28
- Condenser microphones 13, 24
- CONTROL ROOM LEVEL 18, 25
- C-R OUT 17, 18, 21, 25, 46
- C-R PHONES 17, 25
- C-R SOURCE SELECT 18
- C-R SPEAKER SELECT 18
- Cubase 33
- CUBASE READY 17, 34

D

- DAW 14, 18
- DAW I/O 21
- DAW TO AUX 17, 38
- DAW TO ST 16, 37
- Decibel (dB) 9
- DIMMER 18
- DOWN MIX 18, 47
- DRIVE 14
- Driver 49

E

- Equalizer (EQ) 14

F

- FOOT SW 21

G

- GAIN 13, 29

H

- HARDWARE MIX 19, 37
- HIGH 14
- high-pass filter 13, 24
- Hi-Z 14

I

- IEEE1394 21
- INPUT 20
- Input channel 11
- INPUT METER 15, 17
- INPUT SELECT 14
- Input source 41
- INSERT 20

L

- LOW 14

M

- MASTER LEVEL METER 17
- Master section 11
- METER SELECT 17
- Metronome 36
- Microphone 17, 18
- MID 14
- MIDI 21, 49
- MIDI Implementation Chart 65
- Mix 28, 43
- Mixer 10
- Mixing down 45
- Monitor devices 24
- MONITOR REMOTE 19, 40
- Monitor Speaker 23
- Monitoring environment 25
- MORPH 14
- MUTE 18

O

- ON (Channel ON) 12, 15
- OVER 15, 30

P

- PAD 13, 24
- Pan 14, 30
- PFL (Pre-Fader Listen) 16, 32
- PHANTOM [+48V] 13, 24
- Phase 14, 15
- POST 17, 27
- Power 8
- PRE 17, 24
- Preamp 14, 24

R

- REC 15, 19
- Recording 39
- Reverb 14, 16
- REVERB (LEVEL) 16
- REVERB (TIME) 16
- REVERB (TYPE) 16

S

- Solo 15, 32
- SOLO LEVEL 17, 32
- ST 15, 18
- ST MIX 19
- ST OUT 16, 21
- STANDBY 8, 21
- STEREO BAL 16
- STEREO fader 16
- STEREO ON 16
- Surround Monitor 46
- Sweet Spot 28, 48

T

- TALKBACK 18
- Templates 35
- TO AUX 16, 31
- TO REC 16, 31
- TO ST 16, 31
- TRACK CONTROL 19
- TRANSPORT 19

U

- Unbalanced 9

W

- WDM/KS 49
- WET 15, 42
- Work mode 19, 36

Appendix

Specifications

Electrical Specifications

Sampling Frequency	Internal	44.1 kHz, 48 kHz, 88.2 kHz, 96 kHz	
	External	44.1 kHz, 48 kHz, 88.2 kHz, 96 kHz ($\pm 0.1\%$)	
Total Harmonic Distortion	GAIN: Minimum	0.003 % or less (1 kHz @ +18 dB, into 600 Ω)	
Frequency Response (CH IN to STEREO OUT)	fs = 48 kHz	20 Hz–20 kHz, +1, –3 dB @ +4 dB, into 600 Ω	
	fs = 96 kHz	20 Hz–40 kHz, +1, –3 dB @ +4 dB, into 600 Ω	
Dynamic Range (SN ratio at the maximum level)		114 dB, DA converter (STEREO OUT)	
		106 dB, AD + DA (to STEREO OUT)	
Hum & Noise (20 Hz–20 kHz) Rs = 150 Ω		–128 dB, Equivalent input noise	
		–95 dB, Residual output noise, STEREO fader: Minimum	
	GAIN: Maximum PAD: OFF	–95 dB (99 dB SN), STEREO OUT STEREO fader: Nominal level, All channel faders: Minimum	
	GAIN: –60 dB PAD: OFF	–60 dB (64 dB SN), STEREO OUT STEREO fader: Nominal level, One channel fader: Nominal level	
Maximum Voltage Gain	n12	84 dB, CH1–8 to STEREO OUT/C-R OUT	
		50 dB, CH9–12 to STEREO OUT/C-R OUT	
		76 dB, CH1–8 to AUX OUT	
		42 dB, CH9–12 to AUX OUT	
	n8	76 dB, CH1–4 to STEREO OUT/C-R OUT	
		42 dB, CH5–8 to STEREO OUT/C-R OUT	
Crosstalk @ 1 kHz	GAIN: Minimum Adjacent Input	n12	–86 dB, CH1–8
			–80 dB, CH9–12
	n8		–86 dB, CH1–4
			–80 dB, CH5–8

Input and Output Specifications

Analog Input	Type	Input Level		
		Nominal Level	Maximum Level	Input Impedance
INPUT A (Mono) CH1–8 (n12) CH1–4 (n8)	XLR type balanced, +48 V Phantom powered	–60 dBu to +10 dBu	+24 dBu	3.5 k Ω
INPUT B (Mono) CH1–8 (n12) CH1–4 (n8)	TRS phone type, balanced	–60 dBu to +10 dBu	+24 dBu	3.5 k Ω (500 k Ω @ Hi-Z = ON)
INSERT IN	TRS phone type, unbalanced	0 dBu	+14 dBu	10 k Ω
INPUT (Stereo) CH9–12 (n12) CH5–8 (n8)	RCA pin type, unbalanced	–40 dBV to –10 dBV	+4 dBV	10 k Ω
	Phone type, unbalanced	–26 dBu to +4 dBu	+18 dBu	10 k Ω
2TR IN	RCA pin type, unbalanced	–10 dBV	+4 dBV	10 k Ω

Analog Output	Type	Output Level		
		Nominal Level	Maximum Level	Input Impedance
ST OUT	TRS phone type, balanced	+4 dBu	+18 dBu	600 Ω
	RCA pin type, unbalanced	–10 dBV	+4 dBV	10 k Ω
C-R OUT	TRS phone type, balanced	+4 dBu	+18 dBu	600 Ω
AUX OUT (Only n12)	TRS phone type, balanced	+4 dBu	+18 dBu	600 Ω
INSERT OUT	TRS phone type, unbalanced	+4 dBu	+18 dBu	10 k Ω
C-R PHONES, AUX PHONES	TRS phone type, unbalanced	4 mW + 4 mW	25 mW + 25 mW	8 Ω
		12 mW + 12 mW	75 mW + 75 mW	40 Ω

English

Deutsch

Français

Español

General Specifications

Faders	n12	100 mm × 11 (Non-motorized)
	n8	60 mm × 7 (Non-motorized)
Power Requirements	n12	51 W (PA-30)
	n8	33 W (PA-20)
Dimensions (H × D × W)	n12	146 × 561 × 515 mm
	n8	146 × 518 × 368 mm
Net Weight	n12	14 kg
	n8	11 kg
Operating Free-air Temperature Range		+5 to +35 °C
Included Accessories		AC power adaptor (PA-30 (n12), PA-20 (n8)) DVD-ROM (Cubase AI) CD-ROM (TOOLS for n Version2) Owner's Manual TOOLS for n Version2/Cubase AI Installation Guide IEEE 1394 cable

Functions

Monaural Input Channels CH1-8 (n12) CH1-4 (n8) To DIRECT OUT, REC bus, STEREO bus	Analog Input		
	MIC Preamp	Discrete Class-A MIC preamp (Inverted Darlington Circuitry)	
	PHANTOM Switch	+48 V DC (Only for INPUT A, turn on/off every 4 channels)	
	PAD Switch	0/26 dB	
	GAIN Control	44 dB variable (-60 dB to -16 dB)	
	PHASE Switch	Normal/Reversed (CH1-7 (n12), CH1-3 (n8))	
	High Pass Filter Switch	OFF/80 Hz (-12 dB/oct.)	
	Hi-Z Switch	ON/OFF (CH8 (n12), CH4 (n8)), Input impedance: 500 kΩ	
	AD Converter	24 bit linear, Enhanced dual-bit delta-sigma conversion	
	Analog/DAW Input		
	INPUT SELECT Switch	A.IN (analog)/DAW (IEEE1394 jack)	
	COMP LED	Lights in red when the compressor is triggered.	
	MORPH Control	Morphs between 5 Sweet Spot Data	
	DRIVE Control	128 resolution	
	Equalizer	3 band PEQ ±18 dB, MID frequency range: 100 Hz-10 kHz	
	ON Switch	ON/OFF	
	REVERB Control	Adjusts a post-fader signal after PAN	
	AUX Control	Adjusts a pre-fader signal after PAN	
	PAN Control	33 resolution	
	SOLO Switch	ON/OFF	
DIRECT OUT	Pre-fader		
Input Meter		LED × 4: OVER (red), -3 dB (amber), -14 dB (amber), -48 dB (green)	
	n12	Pre-fader/Post-fader	
	n8	Only pre-fader	
WET Switch	WET ON/OFF		
Stereo Input Channels CH9-12 (n12) CH5-8 (n8) To DIRECT OUT, REC bus, STEREO bus	Analog Input		
	GAIN Control	30 dB variable (-26 dB to +4 dB)	
	High Pass Filter Switch	OFF/80 Hz (-12 dB/oct.)	
	AD Converter	24 bit linear, Enhanced dual-bit delta-sigma conversion	
	Analog/DAW Input		
	INPUT SELECT Switch	A.IN (analog)/DAW (IEEE1394 jack)	
	Equalizer	3 band PEQ ±18 dB, MID frequency range: 100 Hz-10 kHz	
	ON Switch	ON/OFF	
	REVERB Control	Adjusts a post-fader signal after PAN	
	AUX Control	Adjusts a pre-fader signal after PAN	
	BAL Control	33 resolution	
	SOLO Switch	ON/OFF	
	DIRECT OUT	Pre-fader	
	Input Meter		LED × 4: OVER (red), -3 dB (amber), -14 dB (amber), -48 dB (green)
		n12	Pre-fader/Post-fader
		n8	Only pre-fader
	WET Switch	WET ON/OFF	

2TR IN To C-R OUT, STEREO bus	LEVEL Control		$-\infty$ to +6 dB (to STEREO bus)/0 dB (to C-R)
	ON Switch		ON/OFF
	AD Converter		24 bit linear, Enhanced dual-bit delta/sigma conversion
ST OUT Outputs CH1-12, 2TR IN, DAW, REVERB, RETURN signals	STEREO Fader	n12	$-\infty$ to +10 dB
		n8	$-\infty$ to +6 dB
	STEREO ON Switch		ON/OFF
	STEREO BAL Control		33 resolution
C-R OUT The BASS MANAGEMENT function works in the surround sound system (Only n12).	CONTROL ROOM LEVEL Control		$-\infty$ to 0 dB
	C-R SPEAKER SELECT Switch	n12	A (L/R), B (C/SW), C (LS/RS) Brackets () indicate sources when 5.1 is selected as C-R SOURCE SELECT.
	C-R SOURCE SELECT Switch	n12	5.1/DAW/STEREO bus/AUX bus/2TR IN
		n8	DAW/STEREO bus/AUX bus/2TR IN
	DOWN MIX Switch	n12	ON/OFF (Active when 5.1 is selected as C-R SOURCE SELECT)
	DIMMER Switch		ON/OFF
	MUTE Switch		ON/OFF
	TALKBACK Switch	n12	ON/OFF
	TALK BACK LEVEL Control	n12	$-\infty$ to +6 dB, Sensitivity: -40 dB
	PFL Switch		ON (SOLO: Pre-fader)/OFF (SOLO: Post-fader)
	DA Converter		24 bit linear, 128 times oversampling Advanced multi-bit delta/sigma conversion
AUX OUT (Only n12) Outputs CH1-12, DAW, REVERB Return, TALK BACK signals	AUX LEVEL Control		$-\infty$ to +6 dB (to AUX bus), $-\infty$ to +6 dB (AUX bus to AUX OUT)
	DA Converter		24 bit linear, 128 times oversampling (@ fs = 44.1 kHz, 48 kHz), 64 times oversampling (@ fs = 88.2 kHz, 96 kHz) advanced multi-bit delta-sigma conversion
PHONES (AUX, C-R)			LEVEL control for each AUX and C-R jacks
	Maximum Output Level		25 mW (@ 8 Ω)/75 mW (@ 40 Ω)
DAW I/O	Audio I/F	n12	16-ch input/16-ch output
		n8	12-ch input/12-ch output
	MIDI I/F		2-port input/2-port output (DAW remote control, Input/Output via MIDI IN/OUT jacks)
MIDI IN/OUT			1 port input/1port output
Output Level Meter	MASTER LEVEL METER	n12	12 points LED meter \times 6
		n8	12 points LED meter \times 2
	METER SELECT Switch		C-R level/Bus level
Reverb To AUX bus, REC bus, STEREO bus	Type		HALL/ROOM/PLATE
	Control		REVERB TIME, LEVEL
DAW Remote Control	WORK MODE		ST MIX/HARDWARE MIX/5.1 MIX (5.1 MIX is only for n12.)
	MONITOR REMOTE		Recording monitor: ON/OFF, VST effects (WET): ON/OFF
	CLICK REMOTE		Click ON/OFF, CLICK LEVEL control
	TRACK CONTROL		PREV, NEXT, REC READY switch
	TRANSPORT		CYCLE, Previous Marker, Add Marker, Next Marker, REW, FWD, STOP, PLAY, REC switch

European models

Purchaser/User Information specified in EN55103-1 and EN55103-2.

Inrush Current: 2.5 A (n12), 2 A (n8)

Conforms to Environments: E1, E2, E3, E4

Europäische Modelle

Käufer/Anwenderinformationen nach EN55103-1 und EN55103-2.

Einschaltstrom: 2.5 A (n12), 2 A (n8)

Einsatzbereiche: E1, E2, E3 und E4

Pour les modèles européens

Les informations acheteur/utilisateur sont spécifiées par les directives EN55103-1 et EN55103-2.

Courant d'appel : 2.5 A (n12), 2 A (n8)

Conformité aux normes environnementales : E1, E2, E3 et E4

Modelos europeos

Información comprador/usuario especificada en EN55103-1 y EN55103-2.

Intensidad de entrada: 2.5 A (n12), 2 A (n8)

Conforme para entornos: E1, E2, E3, E4

Bus connections of n8/n12 and DAW

Cubase 5/Cubase 4/Cubase Studio 5/Cubase Studio 4/Cubase Essential 5/Cubase Essential 4/Cubase AI 5/Cubase AI 4

By installing “n Extension” and using the templates, the input/output buses in Cubase are assigned to the device as follows.

Cubase Output		Device Port		n12 Input	
Output Bus					
n12-L/R	n12-5.1	n12 Monitor L	→	DAW TO ST-L	5.1(L)
		n12 Monitor R	→	DAW TO ST-R	5.1(R)
n12-9/10		n12 Monitor 9/C	→	Input Channel 9	5.1(C)
		n12 Monitor 10/LFE	→	Input Channel 10	5.1(LFE)
n12-11/12		n12 Monitor 11/Ls	→	Input Channel 11	5.1(Ls)
		n12 Monitor 12/Rs	→	Input Channel 12	5.1(Rs)
n12-1		n12 input 1	→	Input Channel 1	
n12-2		n12 input 2	→	Input Channel 2	
n12-3		n12 input 3	→	Input Channel 3	
n12-4		n12 input 4	→	Input Channel 4	
n12-5		n12 input 5	→	Input Channel 5	
n12-6		n12 input 6	→	Input Channel 6	
n12-7		n12 input 7	→	Input Channel 7	
n12-8		n12 input 8	→	Input Channel 8	
n12-AUX		n12 AUX L	→	DAW TO AUX-L	
		n12 AUX R	→	DAW TO AUX-R	

n12 Output		Cubase Input	
		Device Port	Input Bus
CH1 Direct Out	→	n12 Direct Out 1	n12-Dir1
CH2 Direct Out	→	n12 Direct Out 2	n12-Dir2
CH3 Direct Out	→	n12 Direct Out 3	n12-Dir3
CH4 Direct Out	→	n12 Direct Out 4	n12-Dir4
CH5 Direct Out	→	n12 Direct Out 5	n12-Dir5
CH6 Direct Out	→	n12 Direct Out 6	n12-Dir6
CH7 Direct Out	→	n12 Direct Out 7	n12-Dir7
CH8 Direct Out	→	n12 Direct Out 8	n12-Dir8
CH9 Direct Out	→	n12 Direct Out 9	n12-Dir9/10
CH10 Direct Out	→	n12 Direct Out 10	
CH11 Direct Out	→	n12 Direct Out 11	n12-Dir11/12
CH12 Direct Out	→	n12 Direct Out 12	
REC BUS L	→	n12 REC Bus L	n12-REC
REC BUS R	→	n12 REC Bus R	
STEREO BUS L	→	n12 ST Bus L	n12-ST
STEREO BUS R	→	n12 ST Bus R	

Cubase Output		Device Port		n8 Input	
Output Bus					
n8-L/R		n8 Monitor L	→	DAW TO ST-L	
		n8 Monitor R	→	DAW TO ST-R	
n8-5/6		n8 input 5	→	Input Channel 5	
		n8 input 6	→	Input Channel 6	
n8-7/8		n8 input 7	→	Input Channel 7	
		n8 input 8	→	Input Channel 8	
n8-1		n8 input 1	→	Input Channel 1	
n8-2		n8 input 2	→	Input Channel 2	
n8-3		n8 input 3	→	Input Channel 3	
n8-4		n8 input 4	→	Input Channel 4	
n8-AUX		n8 AUX L	→	DAW TO AUX-L	
		n8 AUX R	→	DAW TO AUX-R	

n8 Output		Cubase Input	
		Device Port	Input Bus
CH1 Direct Out	→	n8 Direct Out 1	n8-Dir1
CH2 Direct Out	→	n8 Direct Out 2	n8-Dir2
CH3 Direct Out	→	n8 Direct Out 3	n8-Dir3
CH4 Direct Out	→	n8 Direct Out 4	n8-Dir4
CH5 Direct Out	→	n8 Direct Out 5	n8-Dir5/6
CH6 Direct Out	→	n8 Direct Out 6	
CH7 Direct Out	→	n8 Direct Out 7	n8-Dir7/8
CH8 Direct Out	→	n8 Direct Out 8	
REC BUS L	→	n8 REC Bus L	n8-REC
REC BUS R	→	n8 REC Bus R	
STEREO BUS L	→	n8 ST Bus L	n8-ST
STEREO BUS R	→	n8 ST Bus R	

Other Applications

■ Windows (SONAR 8):

ASIO Driver

Output Device Port		n12 Input	
Yamaha Steinberg FW ASIO n12 Monitor L	→	DAW TO ST-L	5.1(L)
Yamaha Steinberg FW ASIO n12 Monitor R	→	DAW TO ST-R	5.1(R)
Yamaha Steinberg FW ASIO n12 Monitor 9/C	→	Input Channel 9	5.1(C)
Yamaha Steinberg FW ASIO n12 Monitor 10/LFE	→	Input Channel 10	5.1(LFE)
Yamaha Steinberg FW ASIO n12 Monitor 11/Ls	→	Input Channel 11	5.1(Ls)
Yamaha Steinberg FW ASIO n12 Monitor 12/Rs	→	Input Channel 12	5.1(Rs)
Yamaha Steinberg FW ASIO n12 Input 1	→	Input Channel 1	
Yamaha Steinberg FW ASIO n12 Input 2	→	Input Channel 2	
Yamaha Steinberg FW ASIO n12 Input 3	→	Input Channel 3	
Yamaha Steinberg FW ASIO n12 Input 4	→	Input Channel 4	
Yamaha Steinberg FW ASIO n12 Input 5	→	Input Channel 5	
Yamaha Steinberg FW ASIO n12 Input 6	→	Input Channel 6	
Yamaha Steinberg FW ASIO n12 Input 7	→	Input Channel 7	
Yamaha Steinberg FW ASIO n12 Input 8	→	Input Channel 8	
Yamaha Steinberg FW ASIO n12 AUX L	→	DAW TO AUX-L	
Yamaha Steinberg FW ASIO n12 AUX R	→	DAW TO AUX-R	

Output Device Port		n8 Input	
Yamaha Steinberg FW ASIO n8 Monitor L	→	DAW TO ST-L	
Yamaha Steinberg FW ASIO n8 Monitor R	→	DAW TO ST-R	
Yamaha Steinberg FW ASIO n8 input 5	→	Input Channel 5	
Yamaha Steinberg FW ASIO n8 input 6	→	Input Channel 6	
Yamaha Steinberg FW ASIO n8 input 7	→	Input Channel 7	
Yamaha Steinberg FW ASIO n8 input 8	→	Input Channel 8	
Yamaha Steinberg FW ASIO n8 input 1	→	Input Channel 1	
Yamaha Steinberg FW ASIO n8 input 2	→	Input Channel 2	
Yamaha Steinberg FW ASIO n8 input 3	→	Input Channel 3	
Yamaha Steinberg FW ASIO n8 input 4	→	Input Channel 4	
Yamaha Steinberg FW ASIO n8 AUX L	→	DAW TO AUX-L	
Yamaha Steinberg FW ASIO n8 AUX R	→	DAW TO AUX-R	

n12 Output		Input Device Port	
CH1 Direct Out	→	Yamaha Steinberg FW ASIO n12 Direct Out 1	
CH2 Direct Out	→	Yamaha Steinberg FW ASIO n12 Direct Out 2	
CH3 Direct Out	→	Yamaha Steinberg FW ASIO n12 Direct Out 3	
CH4 Direct Out	→	Yamaha Steinberg FW ASIO n12 Direct Out 4	
CH5 Direct Out	→	Yamaha Steinberg FW ASIO n12 Direct Out 5	
CH6 Direct Out	→	Yamaha Steinberg FW ASIO n12 Direct Out 6	
CH7 Direct Out	→	Yamaha Steinberg FW ASIO n12 Direct Out 7	
CH8 Direct Out	→	Yamaha Steinberg FW ASIO n12 Direct Out 8	
CH9 Direct Out	→	Yamaha Steinberg FW ASIO n12 Direct Out 9	
CH10 Direct Out	→	Yamaha Steinberg FW ASIO n12 Direct Out 10	
CH11 Direct Out	→	Yamaha Steinberg FW ASIO n12 Direct Out 11	
CH12 Direct Out	→	Yamaha Steinberg FW ASIO n12 Direct Out 12	
REC BUS L	→	Yamaha Steinberg FW ASIO n12 REC Bus L	
REC BUS R	→	Yamaha Steinberg FW ASIO n12 REC Bus R	
STEREO BUS L	→	Yamaha Steinberg FW ASIO n12 ST Bus L	
STEREO BUS R	→	Yamaha Steinberg FW ASIO n12 ST Bus R	

n8 Output		Input Device Port	
CH1 Direct Out	→	Yamaha Steinberg FW ASIO n8 Direct Out 1	
CH2 Direct Out	→	Yamaha Steinberg FW ASIO n8 Direct Out 2	
CH3 Direct Out	→	Yamaha Steinberg FW ASIO n8 Direct Out 3	
CH4 Direct Out	→	Yamaha Steinberg FW ASIO n8 Direct Out 4	
CH5 Direct Out	→	Yamaha Steinberg FW ASIO n8 Direct Out 5	
CH6 Direct Out	→	Yamaha Steinberg FW ASIO n8 Direct Out 6	
CH7 Direct Out	→	Yamaha Steinberg FW ASIO n8 Direct Out 7	
CH8 Direct Out	→	Yamaha Steinberg FW ASIO n8 Direct Out 8	
REC BUS L	→	Yamaha Steinberg FW ASIO n8 REC Bus L	
REC BUS R	→	Yamaha Steinberg FW ASIO n8 REC Bus R	
STEREO BUS L	→	Yamaha Steinberg FW ASIO n8 ST Bus L	
STEREO BUS R	→	Yamaha Steinberg FW ASIO n8 ST Bus R	

English

Deutsch

Français

Español

■ Macintosh (Logic Pro 8, D.P. 6):

Logic Pro 8

Output Device Port		n12 Input	
Output 1	→	DAW TO ST-L	5.1(L)
Output 2	→	DAW TO ST-R	5.1(R)
Output 3	→	Input Channel 9	5.1(C)
Output 4	→	Input Channel 10	5.1(LFE)
Output 5	→	Input Channel 11	5.1(Ls)
Output 6	→	Input Channel 12	5.1(Rs)
Output 7	→	Input Channel 1	
Output 8	→	Input Channel 2	
Output 9	→	Input Channel 3	
Output 10	→	Input Channel 4	
Output 11	→	Input Channel 5	
Output 12	→	Input Channel 6	
Output 13	→	Input Channel 7	
Output 14	→	Input Channel 8	
Output 15	→	DAW TO AUX-L	
Output 16	→	DAW TO AUX-R	

n12 Output		Input Device Port
CH1 Direct Out	→	Input 1
CH2 Direct Out	→	Input 2
CH3 Direct Out	→	Input 3
CH4 Direct Out	→	Input 4
CH5 Direct Out	→	Input 5
CH6 Direct Out	→	Input 6
CH7 Direct Out	→	Input 7
CH8 Direct Out	→	Input 8
CH9 Direct Out	→	Input 9
CH10 Direct Out	→	Input10
CH11 Direct Out	→	Input11
CH12 Direct Out	→	Input12
REC BUS L	→	Input13
REC BUS R	→	Input14
STEREO BUS L	→	Input15
STEREO BUS R	→	Input16

Output Device Port		n8 Input	
Output 1	→	DAW TO ST-L	
Output 2	→	DAW TO ST-R	
Output 3	→	Input Channel 5	
Output 4	→	Input Channel 6	
Output 5	→	Input Channel 7	
Output 6	→	Input Channel 8	
Output 7	→	Input Channel 1	
Output 8	→	Input Channel 2	
Output 9	→	Input Channel 3	
Output10	→	Input Channel 4	
Output11	→	DAW TO AUX-L	
Output12	→	DAW TO AUX-R	

n8 Output		Input Device Port
CH1 Direct Out	→	Input 1
CH2 Direct Out	→	Input 2
CH3 Direct Out	→	Input 3
CH4 Direct Out	→	Input 4
CH5 Direct Out	→	Input 5
CH6 Direct Out	→	Input 6
CH7 Direct Out	→	Input 7
CH8 Direct Out	→	Input 8
REC BUS L	→	Input 9
REC BUS R	→	Input10
STEREO BUS L	→	Input11
STEREO BUS R	→	Input12

D.P.6

Output Device Port		n12 Input	
Yamaha Steinberg FW:n12 Monitor L 1	→	DAW TO ST-L	5.1(L)
Yamaha Steinberg FW:n12 Monitor R 2	→	DAW TO ST-R	5.1(R)
Yamaha Steinberg FW:n12 Monitor 9/C 3	→	Input Channel 9	5.1(C)
Yamaha Steinberg FW:n12 Monitor 10/LFE 4	→	Input Channel 10	5.1(LFE)
Yamaha Steinberg FW:n12 Monitor 11/Ls 5	→	Input Channel 11	5.1(Ls)
Yamaha Steinberg FW:n12 Monitor 12/Rs 6	→	Input Channel 12	5.1(Rs)
Yamaha Steinberg FW:n12 input 1 7	→	Input Channel 1	
Yamaha Steinberg FW:n12 input 3 9	→	Input Channel 2	
Yamaha Steinberg FW:n12 input 2 8	→	Input Channel 3	
Yamaha Steinberg FW:n12 input 4 10	→	Input Channel 4	
Yamaha Steinberg FW:n12 input 5 11	→	Input Channel 5	
Yamaha Steinberg FW:n12 input 6 12	→	Input Channel 6	
Yamaha Steinberg FW:n12 input 7 13	→	Input Channel 7	
Yamaha Steinberg FW:n12 input 8 14	→	Input Channel 8	
Yamaha Steinberg FW:n12 AUX L 15	→	DAW TO AUX-L	
Yamaha Steinberg FW:n12 AUX R 16	→	DAW TO AUX-R	

n12 Output		Input Device Port
CH1 Direct Out	→	Yamaha Steinberg FW:n12 Direct Out 1 1
CH2 Direct Out	→	Yamaha Steinberg FW:n12 Direct Out 3 3
CH3 Direct Out	→	Yamaha Steinberg FW:n12 Direct Out 2 2
CH4 Direct Out	→	Yamaha Steinberg FW:n12 Direct Out 4 4
CH5 Direct Out	→	Yamaha Steinberg FW:n12 Direct Out 5 5
CH6 Direct Out	→	Yamaha Steinberg FW:n12 Direct Out 6 6
CH7 Direct Out	→	Yamaha Steinberg FW:n12 Direct Out 7 7
CH8 Direct Out	→	Yamaha Steinberg FW:n12 Direct Out 8 8
CH9 Direct Out	→	Yamaha Steinberg FW:n12 Direct Out 9 9
CH10 Direct Out	→	Yamaha Steinberg FW:n12 Direct Out 10 10
CH11 Direct Out	→	Yamaha Steinberg FW:n12 Direct Out 11 11
CH12 Direct Out	→	Yamaha Steinberg FW:n12 Direct Out 12 12
REC BUS L	→	Yamaha Steinberg FW:n12 REC Bus L 13
REC BUS R	→	Yamaha Steinberg FW:n12 REC Bus R 14
STEREO BUS L	→	Yamaha Steinberg FW:n12 ST Bus L 15
STEREO BUS R	→	Yamaha Steinberg FW:n12 ST Bus R 16

Output Device Port		n8 Input	
Yamaha Steinberg FW:n8 Monitor L 1	→	DAW TO ST-L	
Yamaha Steinberg FW:n8 Monitor R 2	→	DAW TO ST-R	
Yamaha Steinberg FW:n8 input 5 3	→	Input Channel 5	
Yamaha Steinberg FW:n8 input 6 4	→	Input Channel 6	
Yamaha Steinberg FW:n8 input 7 5	→	Input Channel 7	
Yamaha Steinberg FW:n8 input 8 6	→	Input Channel 8	
Yamaha Steinberg FW:n8 input 1 7	→	Input Channel 1	
Yamaha Steinberg FW:n8 input 2 8	→	Input Channel 2	
Yamaha Steinberg FW:n8 input 3 9	→	Input Channel 3	
Yamaha Steinberg FW:n8 input 4 10	→	Input Channel 4	
Yamaha Steinberg FW:n8 AUX L 11	→	DAW TO AUX-L	
Yamaha Steinberg FW:n8 AUX R 12	→	DAW TO AUX-R	

n8 Output		Input Device Port
CH1 Direct Out	→	Yamaha Steinberg FW:n8 Direct Out 1 1
CH2 Direct Out	→	Yamaha Steinberg FW:n8 Direct Out 2 2
CH3 Direct Out	→	Yamaha Steinberg FW:n8 Direct Out 3 3
CH4 Direct Out	→	Yamaha Steinberg FW:n8 Direct Out 4 4
CH5 Direct Out	→	Yamaha Steinberg FW:n8 Direct Out 5 5
CH6 Direct Out	→	Yamaha Steinberg FW:n8 Direct Out 6 6
CH7 Direct Out	→	Yamaha Steinberg FW:n8 Direct Out 7 7
CH8 Direct Out	→	Yamaha Steinberg FW:n8 Direct Out 8 8
REC BUS L	→	Yamaha Steinberg FW:n8 REC Bus L 9
REC BUS R	→	Yamaha Steinberg FW:n8 REC Bus R 10
STEREO BUS L	→	Yamaha Steinberg FW:n8 ST Bus L 11
STEREO BUS R	→	Yamaha Steinberg FW:n8 ST Bus R 12

English
Deutsch
Français
Español

Dimensional Diagrams

[n12]

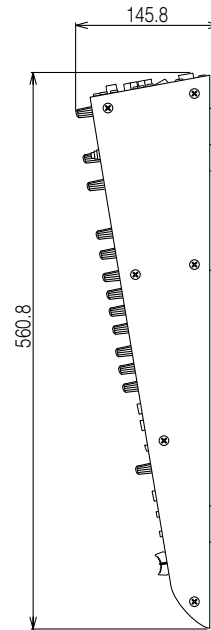
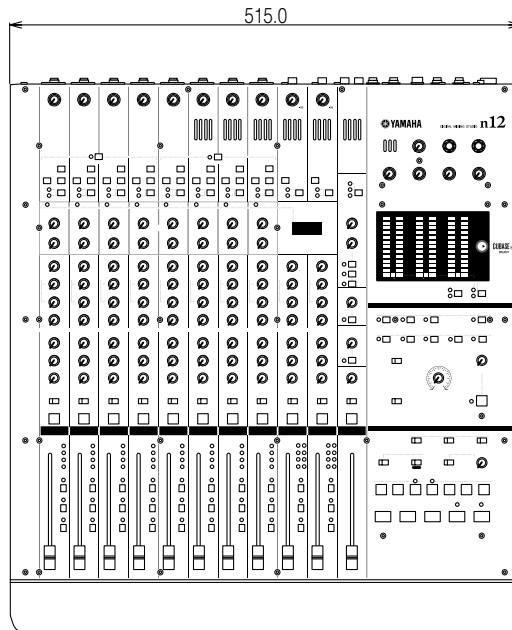
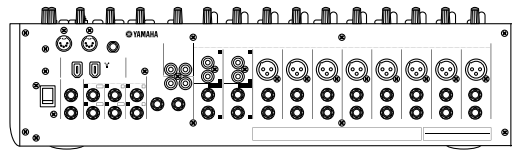

[n8]

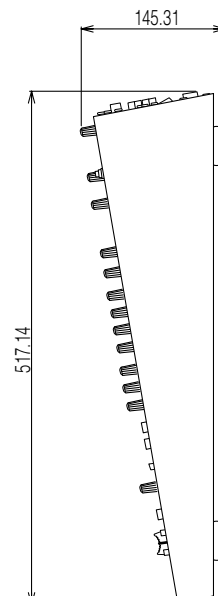
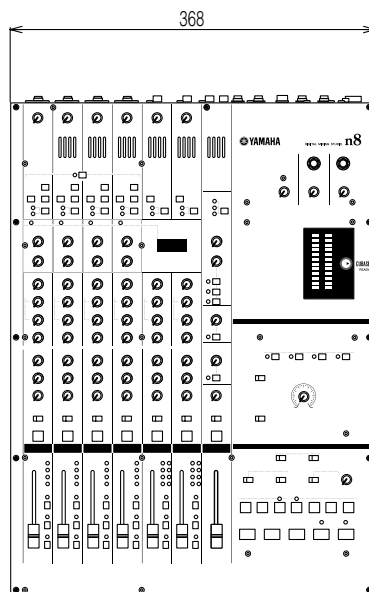
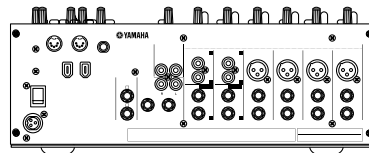

English

Deutsch

Français

Español

Block Diagram

English
Deutsch
Français
Español

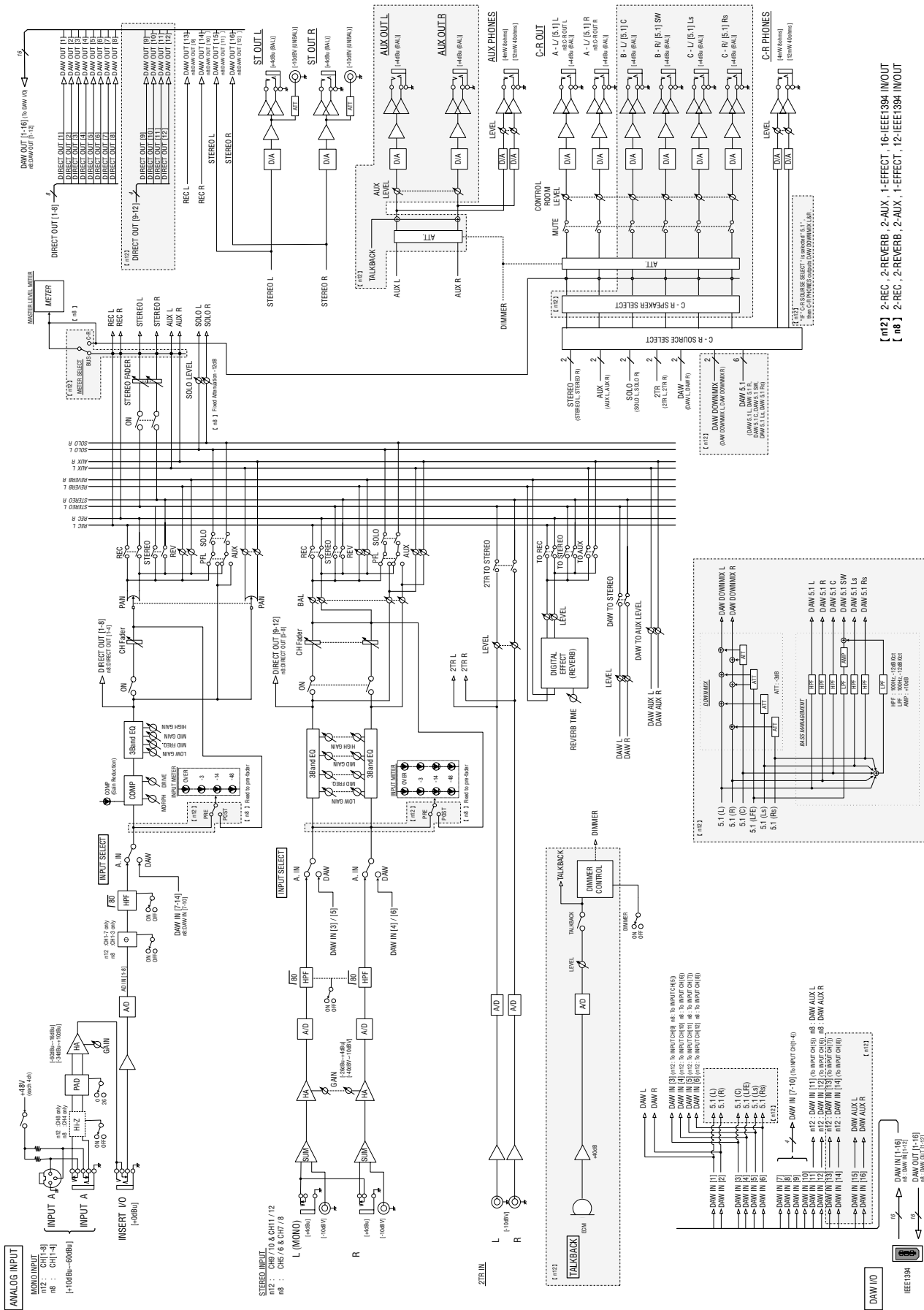

1102 2-REC, 2-REVERB, 2-AUX, 1-EFFECT, 16-IEEE1394 IN/OUT
 1103 2-REC, 2-REVERB, 2-AUX, 1-EFFECT, 12-IEEE1394 IN/OUT

MIDI Implementation Chart

YAMAHA [DIGITAL MIXING STUDIO]
 Model n8/12 MIDI Implementation Chart

Date :5-Oct-2006
 Version :1.0

Function...	Transmitted	Recognized	Remarks
Basic Channel	Default Changed	x x	
Mode	Default Messages Altered	x x *****	
Note Number	: True voice	x *1 *****	x *1 x
Velocity	Note ON Note OFF	x x	x x
After Touch	Key's Ch's	x x	x x
Pitch Bend		x	x
Control Change	0-121	x	x
Prog Change	: True #	x *****	x x
System Exclusive		x *1	x *1
Common	: Song Pos. : Song Sel. : Tune	x x x	x x x
System Real Time	: Clock : Commands	x x	x x
Aux Messages	: All Sound Off : Reset All Cntrls : Local ON/OFF : All Notes OFF : Active Sense : Reset	x x x x x x	x x x x x x
Notes:	*1Used only for the communication with DAW. The MIDI Port is used as an extended port for DAW.		

Mode 1 : OMNI ON, POLY
 Mode 3 : OMNI OFF, POLY

Mode 2 : OMNI ON, MONO
 Mode 4 : OMNI OFF, MONO

o : Yes
 x : No

English

Deutsch

Français

Español

For details of products, please contact your nearest Yamaha representative or the authorized distributor listed below.

Pour plus de détails sur les produits, veuillez-vous adresser à Yamaha ou au distributeur le plus proche de vous figurant dans la liste suivante.

Die Einzelheiten zu Produkten sind bei Ihrer unten aufgeführten Niederlassung und bei Yamaha Vertragshändlern in den jeweiligen Bestimmungsländern erhältlich.

Para detalles sobre productos, contacte su tienda Yamaha más cercana o el distribuidor autorizado que se lista debajo.

NORTH AMERICA

CANADA

Yamaha Canada Music Ltd.
135 Milner Avenue, Scarborough, Ontario,
M1S 3R1, Canada
Tel: 416-298-1311

U.S.A.

Yamaha Corporation of America
6600 Orangethorpe Ave., Buena Park, Calif. 90620,
U.S.A.
Tel: 714-522-9011

CENTRAL & SOUTH AMERICA

MEXICO

Yamaha de México S.A. de C.V.
Calz. Javier Rojo Gómez #1149,
Col. Guadalupe del Moral
C.P. 09300, México, D.F., México
Tel: 55-5804-0600

BRAZIL

Yamaha Musical do Brasil Ltda.
Rua Joaquim Floriano, 913 - 4º andar, Itaim Bibi,
CEP 04534-013 Sao Paulo, SP. BRAZIL
Tel: 011-3704-1377

ARGENTINA

**Yamaha Music Latin America, S.A.
Sucursal de Argentina**
Olga Cossetini 1553, Piso 4 Norte
Madero Este-C1107CEK
Buenos Aires, Argentina
Tel: 011-4119-7000

PANAMA AND OTHER LATIN AMERICAN COUNTRIES/ CARIBBEAN COUNTRIES

Yamaha Music Latin America, S.A.
Torre Banco General, Piso 7, Urbanización Marbella,
Calle 47 y Aquilino de la Guardia,
Ciudad de Panamá, Panamá
Tel: +507-269-5311

EUROPE

THE UNITED KINGDOM/IRELAND

Yamaha Music U.K. Ltd.
Sherbourne Drive, Tilbrook, Milton Keynes,
MK7 8BL, England
Tel: 01908-366700

GERMANY

Yamaha Music Europe GmbH
Siemensstraße 22-34, 25462 Rellingen, Germany
Tel: 04101-3030

SWITZERLAND/LIECHTENSTEIN

**Yamaha Music Europe GmbH
Branch Switzerland in Zürich**
Seefeldstrasse 94, 8008 Zürich, Switzerland
Tel: 01-383 3990

AUSTRIA

Yamaha Music Europe GmbH Branch Austria
Schleiergasse 20, A-1100 Wien, Austria
Tel: 01-60203900

CZECH REPUBLIC/SLOVAKIA/ HUNGARY/SLOVENIA

Yamaha Music Europe GmbH Branch Austria
Schleiergasse 20, A-1100 Wien, Austria
Tel: 01-602039025

POLAND/LITHUANIA/LATVIA/ESTONIA

**Yamaha Music Europe GmbH
Branch Sp.z o.o. Oddział w Polsce**
ul. 17 Stycznia 56, PL-02-146 Warszawa, Poland
Tel: 022-868-07-57

THE NETHERLANDS/ BELGIUM/LUXEMBOURG

Yamaha Music Europe Branch Benelux
Clarissenhof 5-b, 4133 AB Vianen, The Netherlands
Tel: 0347-358 040

FRANCE

Yamaha Musique France
BP 70-77312 Marne-la-Vallée Cedex 2, France
Tel: 01-64-61-4000

ITALY

**Yamaha Musica Italia S.P.A.
Combo Division**
Viale Italia 88, 20020 Lainate (Milano), Italy
Tel: 02-935-771

SPAIN/PORTUGAL

Yamaha Música Ibérica, S.A.
Ctra. de la Coruna km. 17, 200, 28230
Las Rozas (Madrid), Spain
Tel: 91-639-8888

GREECE

Philippos Nakas S.A. The Music House
147 Skiathou Street, 112-55 Athens, Greece
Tel: 01-228 2160

SWEDEN

Yamaha Scandinavia AB
J. A. Wettergrens Gata 1, Box 30053
S-400 43 Göteborg, Sweden
Tel: 031 89 34 00

DENMARK

YS Copenhagen Liaison Office
Generatorvej 6A, DK-2730 Herlev, Denmark
Tel: 44 92 49 00

FINLAND

F-Musiikki Oy
Kluuvikatu 6, P.O. Box 260,
SF-00101 Helsinki, Finland
Tel: 09 618511

NORWAY

Norsk filial av Yamaha Scandinavia AB
Grini Næringspark 1, N-1345 Østerås, Norway
Tel: 67 16 77 70

ICELAND

Skifan HF
Skeifan 17 P.O. Box 8120, IS-128 Reykjavik, Iceland
Tel: 525 5000

RUSSIA

Yamaha Music (Russia)
Office 4015, entrance 2, 21/5 Kuznetskii
Most street, Moscow, 107996, Russia
Tel: 495 626 0660

OTHER EUROPEAN COUNTRIES

Yamaha Music Europe GmbH
Siemensstraße 22-34, 25462 Rellingen, Germany
Tel: +49-4101-3030

AFRICA

**Yamaha Corporation,
Asia-Pacific Music Marketing Group**
Nakazawa-cho 10-1, Naka-ku, Hamamatsu,
Japan 430-8650
Tel: +81-53-460-2312

MIDDLE EAST

TURKEY/CYPRUS

Yamaha Music Europe GmbH
Siemensstraße 22-34, 25462 Rellingen, Germany
Tel: 04101-3030

OTHER COUNTRIES

Yamaha Music Gulf FZE
LOB 16-513, P.O.Box 17328, Jubel Ali,
Dubai, United Arab Emirates
Tel: +971-4-881-5868

ASIA

THE PEOPLE'S REPUBLIC OF CHINA

Yamaha Music & Electronics (China) Co., Ltd.
2F, Yunhedasha, 1818 Xinzha-lu, Jingan-qu,
Shanghai, China
Tel: 021-6247-2211

HONG KONG

Tom Lee Music Co., Ltd.
11/F., Silvercord Tower 1, 30 Canton Road,
Tsimshatsui, Kowloon, Hong Kong
Tel: 2737-7688

INDIA

Yamaha Music India Pvt. Ltd.
5F Ambience Corporate Tower Ambience Mall Complex
Ambience Island, NH-8, Gurgaon-122001, Haryana, India
Tel: 0124-466-5551

INDONESIA

**PT. Yamaha Music Indonesia (Distributor)
PT. Nusantik**
Gedung Yamaha Music Center, Jalan Jend. Gatot
Subroto Kav. 4, Jakarta 12930, Indonesia
Tel: 21-520-2577

KOREA

Yamaha Music Korea Ltd.
8F, 9F, Dongsung Bldg. 158-9 Samsung-Dong,
Kangnam-Gu, Seoul, Korea
Tel: 080-004-0022

MALAYSIA

Yamaha Music Malaysia, Sdn., Bhd.
Lot 8, Jalan Perbandaran, 47301 Kelana Jaya,
Petaling Jaya, Selangor, Malaysia
Tel: 3-78030900

PHILIPPINES

Yupango Music Corporation
339 Gil J. Puyat Avenue, P.O. Box 885 MCPO,
Makati, Metro Manila, Philippines
Tel: 819-7551

SINGAPORE

Yamaha Music Asia Pte., Ltd.
#03-11 A-Z Building
140 Paya Lebar Road, Singapore 409015
Tel: 747-4374

TAIWAN

Yamaha KHS Music Co., Ltd.
3F, #6, Sec.2, Nan Jing E. Rd. Taipei.
Taiwan 104, R.O.C.
Tel: 02-2511-8688

THAILAND

Siam Music Yamaha Co., Ltd.
4, 6, 15 and 16th floor, Siam Motors Building,
891/1 Rama 1 Road, Wangmai,
Pathumwan, Bangkok 10330, Thailand
Tel: 02-215-2626

OTHER ASIAN COUNTRIES

**Yamaha Corporation,
Asia-Pacific Music Marketing Group**
Nakazawa-cho 10-1, Naka-ku, Hamamatsu,
Japan 430-8650
Tel: +81-53-460-2317

OCEANIA

AUSTRALIA

Yamaha Music Australia Pty. Ltd.
Level 1, 99 Queensbridge Street, Southbank,
Victoria 3006, Australia
Tel: 3-9693-5111

NEW ZEALAND

Music Works LTD
P.O. BOX 6246 Wellesley, Auckland 4680,
New Zealand
Tel: 9-634-0099

COUNTRIES AND TRUST TERRITORIES IN PACIFIC OCEAN

**Yamaha Corporation,
Asia-Pacific Music Marketing Group**
Nakazawa-cho 10-1, Naka-ku, Hamamatsu,
Japan 430-8650
Tel: +81-53-460-2312

HEAD OFFICE Yamaha Corporation, Pro Audio & Digital Musical Instrument Division
Nakazawa-cho 10-1, Naka-ku, Hamamatsu, Japan 430-8650
Tel: +81-53-460-2445

SY51

Yamaha Web Site (English only)
<http://www.yamahasynth.com/>
Yamaha Manual Library
<http://www.yamaha.co.jp/manual/>

U.R.G., Pro Audio & Digital Musical Instrument Division, Yamaha Corporation
© 2007-2009 Yamaha Corporation

WU25290 912APZC.?.?-04E0