

YAMAHA



DIGITAL SEQUENCE RECORDER

OWNER'S MANUAL

SUPPLEMENTAL MARKING INFORMATION

Yamaha Digital Musical Instrument Products will have either a label similar to the graphic shown below or a molded/stamped facsimile of the graphic on its enclosure. The explanation of these graphics appears on this page. Please observe all cautions indicated.

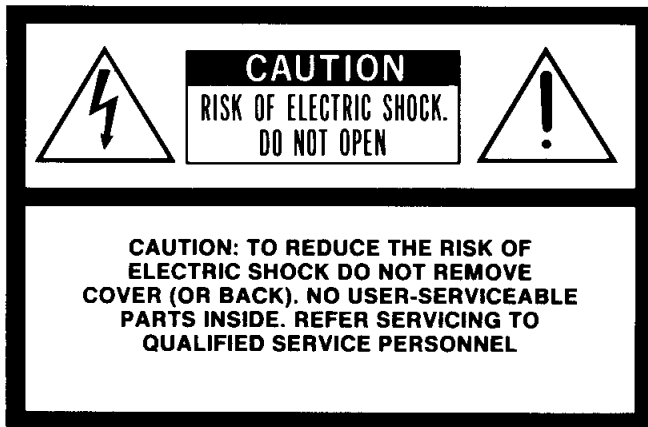

SEE BOTTOM OF UNIT FOR GRAPHIC SYMBOL MARKINGS.



The Exclamation point within an equilateral triangle is intended to alert the user to the presence of important operating and maintenance (servicing) instructions in the literature accompanying the product.



The lightning flash with arrowhead symbol, within an equilateral triangle, is intended to alert the user to the presence of uninsulated "dangerous voltage" within the product's enclosure that may be of sufficient magnitude to constitute a risk of electric shock to persons.

SPECIAL MESSAGE SECTION

ELECTROMAGNETIC INTERFERENCE (RFI): Your Yamaha Digital Musical Instrument Product has been type tested and found to comply with all applicable regulations. However, if it is installed in the immediate proximity of other electronic devices, some form of interference may occur. For additional RFI information see FCC information section located in this manual.

IMPORTANT NOTICE: This product has been tested and approved by independent safety testing laboratories in order that you may be sure that when it is properly installed and used in its normal and customary manner, all foreseeable risks have been eliminated. **DO NOT** modify this unit or commission others to do so unless specifically authorized by Yamaha. Product performance and/or safety standards may be diminished. Claims filed under the expressed warranty may be denied if the unit is/has been modified. Implied warranties may also be affected.

SPECIFICATIONS SUBJECT TO CHANGE: The information contained in this manual is believed to be correct at the time of printing. Yamaha reserves the right to change or modify specifications at any time without notice or obligation to update existing units.

NOTICE: Service charges incurred due to a lack of knowledge relating to how a function or effect works (when the unit is operating as designed), are not covered by the manufacturer's warranty. Please study this manual carefully before requesting service.

NAME PLATE LOCATION: The graphic below indicates the location of the Name Plate on your Yamaha Digital Musical Instrument. The Model, Serial Number, Power requirements,

etc., are indicated on this plate. You should note the model, serial number and the date of purchase in the spaces provided below and retain this manual as a permanent record of your purchase.

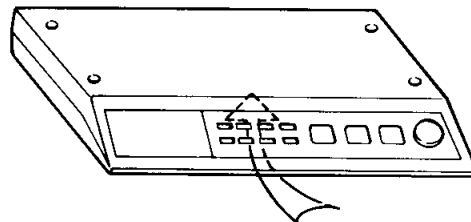

STATIC ELECTRICITY CAUTION: Some Yamaha Digital Musical Instrument products have modules that plug into the unit to perform various functions. The contents of a plug-in module can be altered/damaged by static electricity discharges. Static electricity build-ups are more likely to occur during cold winter months (or in areas with very dry climates) when the natural humidity is low. To avoid possible damage to the plug-in module, touch any metal object (a metal desk lamp, a door knob, etc.) before handling the module. If static electricity is a problem in your area, you may want to have your carpet treated with a substance that reduces static electricity build-up. See your local carpet retailer for professional advice that relates to your specific situation.

Model _____

Serial No. _____

Purchase Date _____

This information on safety is provided to comply with U.S.A. laws, but should be observed by users in all countries.

INTRODUCTION

Congratulations on your purchase of a Yamaha QX21 Digital Sequence Recorder! Your QX21 Digital Sequence Recorder offers high-performance 2-track digital sequencing in any MIDI-based digital music system. The QX21 is capable of recording anything you play on any Yamaha DX synthesizer or other MIDI keyboard — complete with touch response and function parameters such as pitch bend, modulation, etc. The things you record will be true to life. You can also write in notes in the “step” mode, letting you create pieces that would be impossible to play live. Overdubbing capability is practically unlimited, and you can control more than one FM tone generator — say a DX11 Digital Programmable Algorithm Synthesizer and a TX81Z FM Tone Generator — letting you sequence more than one voice at a time. Furthermore, a range of useful editing and other control functions lets you modify and enhance your compositions with ease. And there’s a cassette interface so you can save all your hard work on a standard cassette recorder for later use.

The QX21 Digital Sequence Recorder can give you virtually unlimited capability for creative, digital music production.



IMPORTANT

This manual is organized in tutorial form. Therefore, in order to fully understand all aspects of operating the QX21, we urge you to go through the manual and try out each operation as it is described.

CONTENTS

PRECAUTIONS	3	Metronome Mode	17
CONNECTIONS	4	Clock Select	17
PANEL CONTROLS	5	Song Position Pointer	18
BASIC RECORDING & EDITING PROCEDURES		UTILITY FUNCTIONS	
REAL TIME RECORDING	7	After Touch	19
Erase	8	Control Change & Pitch Bend	19
Repeat	9	Key Velocity	19
Overdubbing	9	Echo Back	19
Exchange	9	Protect	20
Using the TRACK Buttons	10	Display MIDI Status	20
Track Down	10	Save Temporary Buffer	21
Insert	11	Delete Channel	21
Delete Measure	11	Quantize	21
Chain	11	Cassette Save/Verify/Load	22
STEP RECORDING	12	Local Device Number	23
Footswitch STOP/START	14	Show Free Area	23
SEQUENCING MULTIPLE TONE GENERATORS		ERROR MESSAGES	24
Connecting Multiple Tone Generators	15	SPECIFICATIONS	25
MIDI Channel Number	16	MIDI DATA FORMAT	26
METRONOME/TIMING CONTROL FUNCTIONS			
Beat/Measure	17		

PRECAUTIONS

- Avoid placing the QX21 in locations exposed to direct sunlight or high temperatures, excessively high or low humidity, high dust concentrations, or vibration.
- Be sure to connect the QX21 to an AC power supply that meets the power supply specifications listed on the rear of the unit.
- If there is any danger of lightning occurring nearby, remove the power plug from the wall socket in advance.
- Be sure to make all connections properly, as described in the "CONNECTIONS" section (next page).
- To avoid damaging your speakers and other playback equipment, turn off the power of all related equipment before making connections.
- Do not use excessive force in handling control switches and knobs.
- To avoid broken cords and short circuits, be sure to unplug all connectors by grasping the respective plugs — NOT the cords.
- Remove the power plug from the AC mains socket if the unit is not to be used for an extended period of time.
- Remove all plugs and connections if the unit is to be transported, to prevent damage to the cords and jacks.
- Do not use solvents such as benzene or paint thinner to clean the unit. Do not use insecticides or other pressurized spray products in proximity to the unit. Wipe off the exterior with soft cloth.

STORAGE OF DATA

- This unit is equipped with a back-up function for recorded data. However, important data should be saved onto cassette tape before starting a new recording.

EFFECTS ON OTHER ELECTRONIC EQUIPMENT

- Since this unit incorporates digital circuitry, simultaneous use of other equipment such as TVs, radios, etc. in close proximity may cause noise and erroneous operation. If this occurs, separate the affected units sufficiently to eliminate the problem. It is also a good idea to use separate line filters on each piece of equipment.

CONNECTIONS

This diagram represents the most basic system. For a multiple tone generator system see "SEQUENCING MULTIPLE TONE GENERATORS" on page 15.

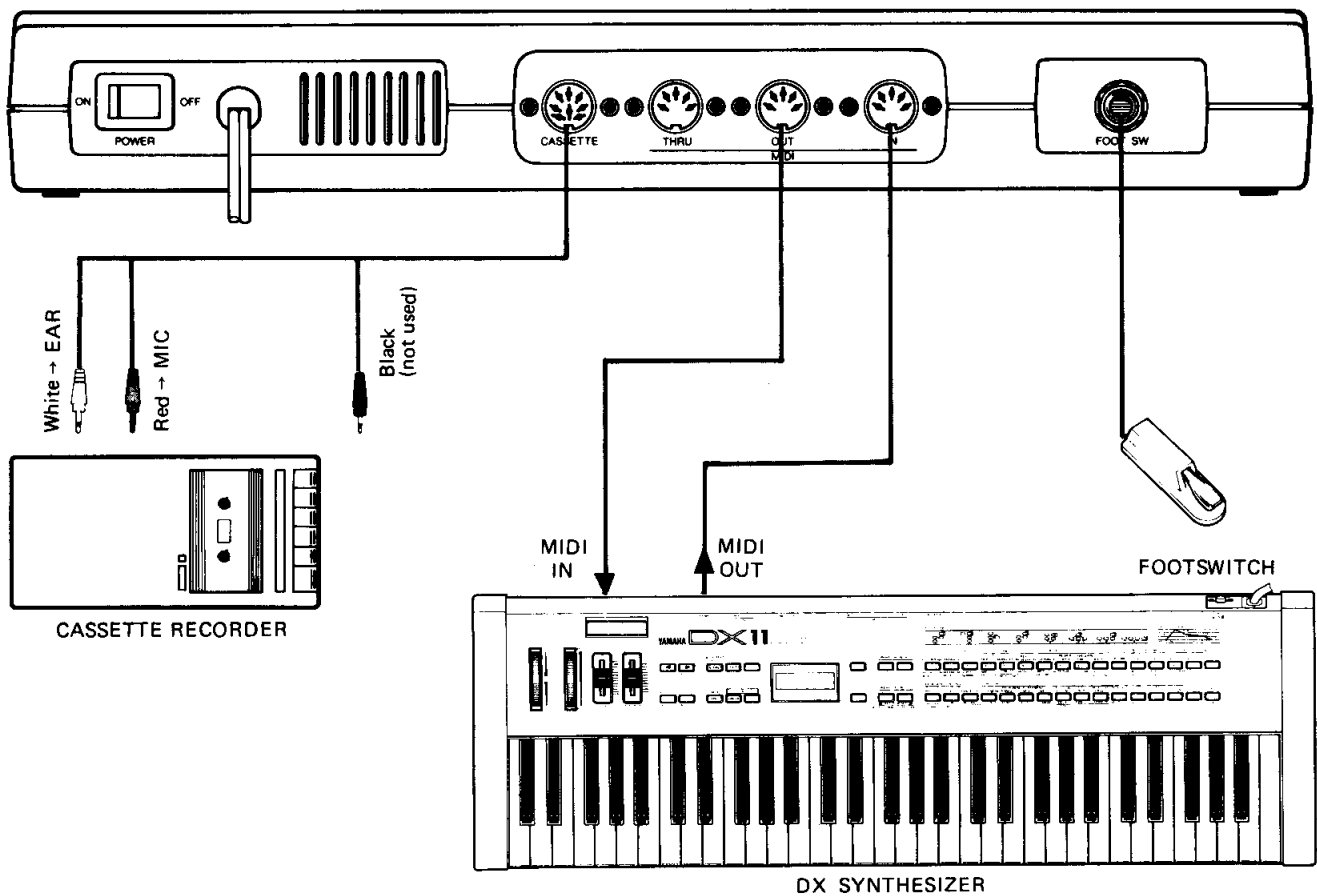

PANEL CONTROLS

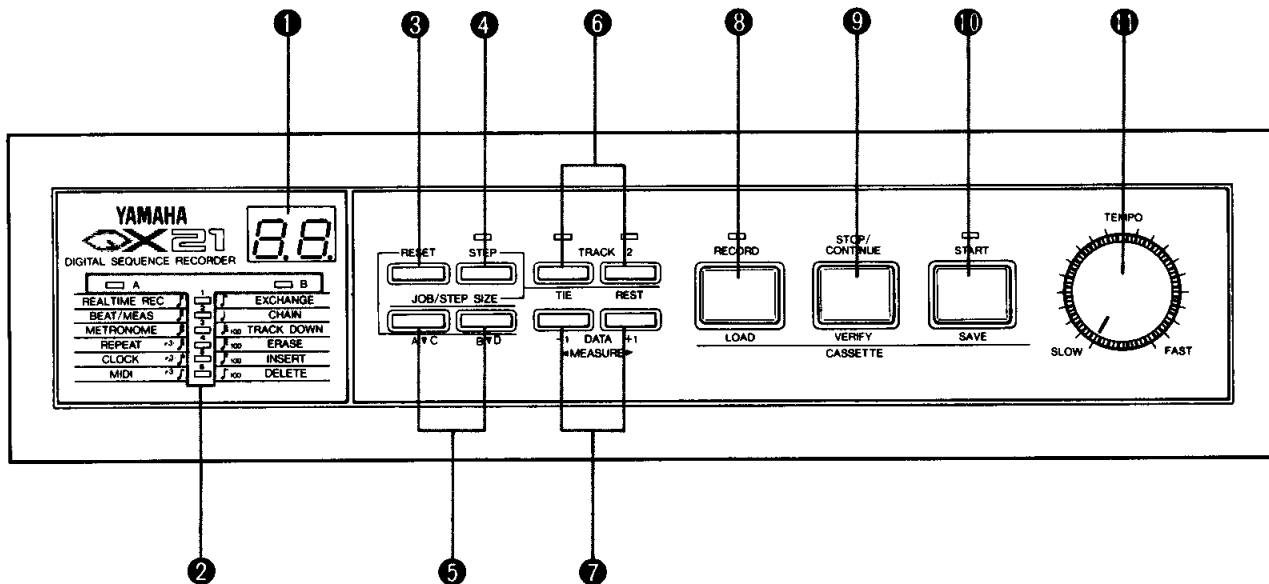

1. LED Display

Indicates current measure as well as selected control functions and their selected values/modes. The flashing red dot at the lower right hand corner of the display indicates the tempo currently set by the TEMPO control (11).

2. Job List and Indicators

The A and B lists printed on the panel correspond to the "Job" functions which can be called using the JOB/STEP SIZE selectors (5). The LED indicator next to the "A" or "B" list marking lights to indicate which list is active, and the LEDs numbered 1 through 6—between the lists—light to indicate which job within the active list is currently selected. Note that the lists also contain note length markings. These are used in the step recording mode to select the note length to be recorded. Another two job lists—C and D, printed on the QX21 top panel—are actually available and can be called using the JOB/STEP SIZE selectors in conjunction with the RESET button.

3. RESET Button

Pressing the RESET button causes the following:

- Recording or playback is interrupted.
- Measure 1 is selected.
- Job A-1 is selected.
- The step recording mode is exited.
- Cassette save, verify and load are interrupted.

4. STEP Button

This button activates the step recording mode.

5. JOB/STEP SIZE Selectors

These buttons are used in conjunction with the job A/C—B/D list and indicators (2) to select the desired Job (function) or select the desired note length when recording in the step mode.

6. TRACK 1/TIE and TRACK 2/REST Buttons

These buttons select playback of the corresponding tracks. They also function as the tie and rest entry buttons when recording in the step mode.

7. -1 and +1 DATA/MEASURE Selectors

These buttons increment and decrement through the measures of a recorded composition to facilitate editing. They also permit selection of values for certain control functions.

8. RECORD/LOAD Button

Activates the record mode. Also activates cassette load when the cassette job is active.

9. STOP/CONTINUE/VERIFY Button

Stops or continues recording or playback. Also activates cassette verify when the cassette job is active.

10. START/SAVE Button

Starts recording or playback. Also activates cassette save when the cassette job is active.

11. TEMPO Control

Sets the tempo for recording and playback.

BASIC RECORDING & EDITING PROCEDURES

Real time and step recording with the QX21 are remarkably simple procedures. But before you try recording anything, make sure that the MIDI OUT from your keyboard is connected to the QX21 MIDI IN terminal, and that the MIDI OUT from the QX21 is connected to the MIDI IN of your keyboard, as shown in the basic connection diagram given on page 4. Also, note that with the QX21 YOU WILL ALWAYS RECORD ON TRACK 1.

REAL TIME RECORDING (Job A-1)

Assuming that you are just starting and that nothing has been recorded in the QX21, both TRACK LEDs will be out, as will the RECORD and START LEDs, and job A-1 (REALTIME REC) on the job lists will be selected. Set the TEMPO control for the desired tempo—indicated by the flashing dot at the lower right-hand corner of the digital LED display. Press the RECORD button to activate the record standby mode. The RECORD LED should now be lit, and the TRACK 1 LED should be flashing. Now press the START button and the QX21 will give you a two-measure count in: the metronome will beep 8 times (if 4/4 time, the default time signature, is selected) and the digital LED display will count from -8 to -1. All you have to do is start playing on the keyboard from the first measure, using the metronome as a rhythmic guide (note that the metronome beeps at a higher pitch on the first beat of each measure). When you're finished, press the STOP/CONTINUE button to exit the record mode. Note that if you press the STOP/CONTINUE button in the middle of a measure, the record mode will be exited at the end of that measure. Now, to hear what you have just recorded, simply press the START button. Tempo can be adjusted during playback by using the TEMPO control. When playback finishes the playback mode will be exited and the LED display will read 30 indicating the end of the recording.

RECORD PROCEDURE

- 1 Set tempo

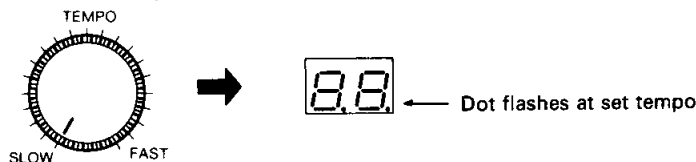

- 2 Activate record standby

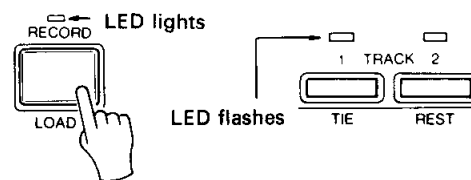

- 3 Start recording

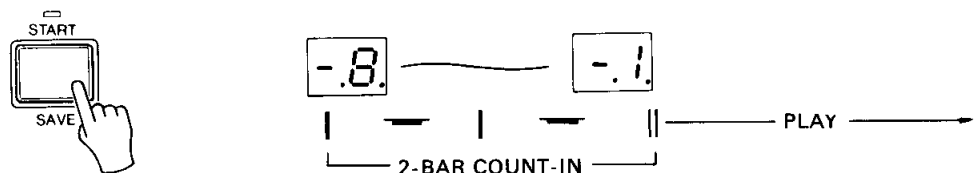

4 Stop recording



NOTE:

The default time signature for real time and step recording is 4/4. Other time signature can be selected using the Beats/Measure job described in the METRONOME/-TIMING CONTROL FUNCTIONS section on page 17.

Erase (Job B-4)

The ERASE "job" lets you erase all of track 1, or all track 1 data following a specified measure. To erase what you have just recorded, first call the ERASE job (job B-4) by pressing the JOB/STEP SIZE B/D selector 4 times if you start with job A-1 active (LEDs "B" and "4" will be lit). The LED display will now alternately read $E5$ and the number of the currently selected measure or the end marking $7C$. You can now use the -1 and +1 buttons to scroll through the recording (one press moves one measure in the specified direction, while holding one of the buttons down scrolls continuously in the specified direction) in order to specify the measure from which you want to begin the erase operation. To erase the entire track, scroll to measure 1. To erase everything from measure 3 onwards, scroll to measure 3. Press the START button to actually execute the erase operation. To cancel the ERASE job without executing the ERASE operation, simply press RESET. If you erase the entire track the TRACK 1 LED will go out, indicating that there is no more data in the track. Once ERASE has been executed, the QX21 will automatically return to the stop mode and job A-1 will be selected.

ERASE PROCEDURE

- 1 Select job B-4

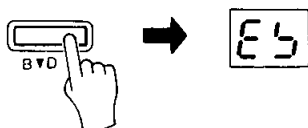

- 2 Select measure to erase from

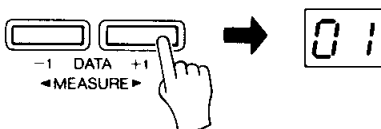

- 3 Execute erase job

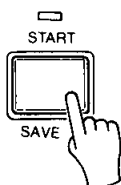

Repeat (Job A-4)

Recorded material can be automatically repeated from 1 to 99 times by setting the REPEAT Job (job A-4). First, call the REPEAT job by pressing the JOB/STEP SIZE A/C selector 3 times (LEDs "A" and "4" will be lit). The LED display will now alternately display \overline{rP} , indicating that the REPEAT job has been called, and $\overline{0F}$ indicating that REPEAT is OFF. Press the +1 button once to turn REPEAT ON ($\overline{0n}$) for endless repeat. Subsequent presses on the +1 button select 1, 2, 3.....99 repeats. The -1 button can be used to scroll backwards through the REPEAT numbers, and turn REPEAT OFF if desired. Of course, the +1 and -1 buttons may be held to scroll quickly through the REPEAT numbers. Once the desired number of repeats has been set you can return to job A-1 using the JOB/STEP SIZE A/C selector, or simply by pressing the RESET button.

REPEAT PROCEDURE

- 1 Select repeat job

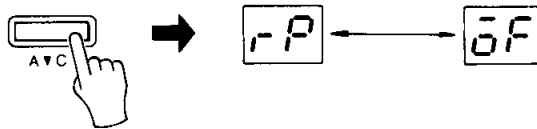

- 2 Turn repeat on

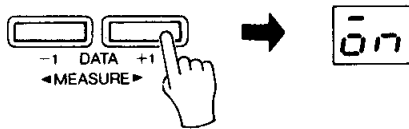

- 3 Set number of repeats

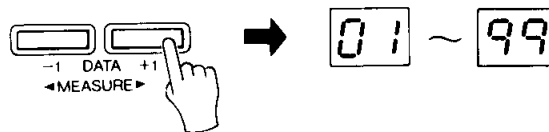

- 4 Return to job A-1

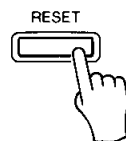

Overdubbing

Overdubbing—recording one track over another—on the QX21 is accomplished by using two jobs: EXCHANGE and TRACK DOWN. Both functions are described below. EXCHANGE, however, is used for the first overdub only, while TRACK DOWN is used for all subsequent overdubs.

Exchange (Job B-1)

Although using the EXCHANGE job is the first step in overdubbing over the first recorded track, it is also useful in several other situations. Basically, all EXCHANGE does is to interchange the data on tracks 1 and 2: the data from track 1 is moved to track 2, while the data on track 2 is moved to track 1. For the purpose of overdubbing, the EXCHANGE job is called (press JOB/STEP SIZE B/D selector once from job A-1) after recording the first track on TRACK 1. When the EXCHANGE job is called the LED display will read \overline{E} . Execute the EXCHANGE job by pressing the START button. You can cancel the EXCHANGE job prior to executing by pressing

RESET. The material you recorded on TRACK 1 will now be on TRACK 2 (the TRACK 2 LED will light), and since TRACK 2 was empty, TRACK 1 will now be empty and its LED will go out. If you now play the recording by pressing the START button, you will actually be hearing TRACK 2. Now to overdub the second track, simply follow the normal real time record process: press RECORD and then PLAY. You will now be able to record the second track—on TRACK 1—while listening to the first track which is now on Track 2. Press STOP/CONTINUE when you're finished. To hear both tracks played together, simply press START.

Since some operations can only be carried out on data on TRACK 1, the EXCHANGE job is also used to swap tracks in order to perform some operation—ERASE, for example—on the TRACK 2 data. The normal track positions can then be resumed by executing EXCHANGE again.

EXCHANGE PROCEDURE

- 1 Select exchange job

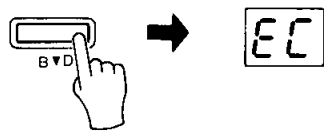

- 2 Execute exchange job

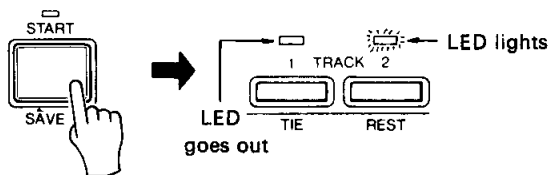

Using the TRACK Buttons

When a track contains data, the corresponding TRACK button can be used to turn that track on or off. This is handy when both tracks contain data, but you want to listen to only the material recorded on one track. Pressing the TRACK button alternates between the ON and OFF modes: LED ON = track ON.

Track Down (Job B-3)

This job is only used when both TRACK 1 and 2 contain data, such as prior to recording a third overdub. The TRACK DOWN job combines (mixes) the data on TRACK 1 and TRACK 2, and places the result on TRACK 2. TRACK 1 is left empty. Now, supposing you have recorded your first two tracks and have data on both TRACK 1 and TRACK 2, call the TRACK DOWN job by pressing the JOB/STEP SIZE B/D selector three times (LEDs "B" and "3" will be lit). The LED display will read $\begin{bmatrix} E \\ 3 \end{bmatrix}$, indicating that the TRACK DOWN job is active. Execute the job by pressing the START button (or cancel by pressing RESET). The TRACK 1 indicator will go out, and tracks 1 and 2 will now be combined on TRACK 2. Verify this by playing TRACK 2. The third overdub can now be recorded on TRACK 1 in the normal way. Subsequent overdubs are all carried out in the same fashion: using REAL TIME REC and TRACK DOWN.

TRACK DOWN

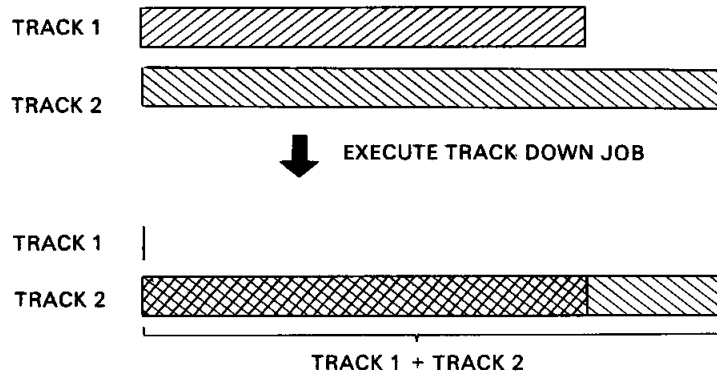

Insert (Job B-5)

This job allows material recorded on TRACK 1 to be inserted anywhere in TRACK 2. Suppose that you have recorded and overdubbed eight measures of music, and that TRACK DOWN has been used so that all data now resides on TRACK 2. You can now add a few bars between measures 4 and 5 of the TRACK 2 data in the following way:

Record the material to be inserted on TRACK 1, then call the INSERT job by pressing the JOB/STEP SIZE B/D selector 5 times (LEDs "B" and "5" will be lit). The LED display will now alternately read indicating that the INSERT job is active, and the currently selected measure number. Use the -1 and +1 buttons to scroll to the measure immediately following the insert point 5 in this case (i.e. the new material will be inserted prior to the selected measure). Press START to execute the insert, or RESET to cancel. The insert material recorded on TRACK 1 is not erased when the INSERT job is executed.

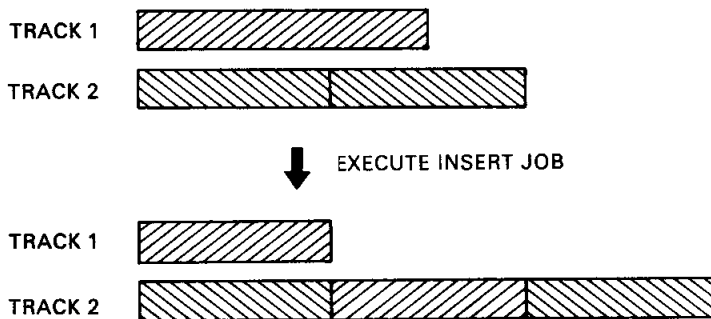

Delete Measure (Job B-6)

This job makes it possible to delete any specified measure on TRACK 1. Simply call the DELETE job by pressing the JOB/STEP SIZE B/D selector 6 times from the stop mode (LEDs "B" and "6" on the job list will be lit). The LED display will now alternately read indicating that the DELETE job is active, and the currently selected measure number. Select the TRACK 1 measure to be deleted using the -1 and +1 buttons, then execute the DELETE by pressing START (or cancel by pressing RESET).













Chain (Job B-2)

The CHAIN job appends the data on TRACK 1 onto the end of TRACK 2. Call the CHAIN job by pressing the JOB/STEP SIZE B/D selector twice from job A-1 (LEDs "B" and "2" will be lit). The LED display will read indicating that the CHAIN job is active. Press the START button to execute the CHAIN job, or press RESET to cancel. The data on TRACK 1 is not erased.

STEP RECORDING

In the step recording mode, notes, chords and rests are input one at a time from the recording keyboard, the note length of each being determined by the STEP SIZE setting. Since the data is not entered in real time, this mode is ideal for entering extremely fast or complex lines which would be impossible to play in real time. The step recording mode is activated by pressing the STEP button. The TRACK 1 indicator will light, the STEP indicator will flash, and the current measure number (or end mark) will be displayed on the digital LED display. If TRACK 1 contains no data you will automatically begin recording from the first measure. If, however, you will begin recording from a specific measure within or at the end of already-recorded material, use the -1 and +1 buttons at this point to locate the measure from which you will begin recording.

The actual length of the each note entered is specified using the JOB/STEP SIZE selectors and the note markings on the job lists. The available note lengths are:

- A-1 =  1/16 note.
- A-2 =  1/32 note.
- A-3 =  1/64 note.
- A-4 =  1/32 note triplet.
- A-5 =  1/16 note triplet.
- A-6 =  1/8 note triplet.
- B-1 =  1/8 note.
- B-2 =  1/4 note.
- B-3 =  1/64 note with 100% gate time.
- B-4 =  1/32 note with 100% gate time.
- B-5 =  1/16 note with 100% gate time.
- B-6 =  1/8 note with 100% gate time.

NOTE:

Normal note gate time is 80%. The 100% gate time notes are used to create legato phrasings.

To begin actual recording, press the RECORD button—the RECORD indicator will light—and then the START button—the START indicator will light. The QX21 is now waiting for you to input the first note. To record, first select the desired note length—just as you normally select different jobs—using the JOB/STEP SIZE selectors, play the appropriate note or chord on the keyboard, select the next note length, play the next note or chord on the keyboard.....and so on. The measure count will be updated as you “fill” each measure with notes, chords and rests.

The dots at the bottom of the LED display indicate which beat of the current measure is being entered.



1st beat



2nd beat



3rd beat



4th beat

All the available note lengths can be entered as rests simply by pressing the REST button instead of playing a note or chord on the keyboard. The +1 button can be used at any point during a measure to fill the remainder of the measure with rests and skip to the beginning of the next measure. If the +1 button is pressed at the beginning of a measure, a full measure rest will be entered. The -1 button can be used to return to the beginning of the current measure in order to re-enter the data for that measure.

Notes or rests can be tied to the following note or rest, of any length, using the TIE button. Only notes of the same pitch can be tied together. For example, to tie a 1/16 note to another 1/16 note, enter the first 1/16 note, then press the TIE button. This effectively creates an 1/8 note (two tied 1/16 notes). A 1/4 note could be tied to an 1/8 note by first entering the 1/4 note, selecting the 1/8 note length on the job lists, then pressing the TIE button. This will give you the equivalent of a dotted 1/4 note. Naturally, notes can be tied across the measure lines. When you are finished recording press the STOP/CONTINUE button. Press START to hear what you have recorded.

*When entering single notes in the step write mode, be sure to enter ONE NOTE AT A TIME! If you play a second note while the previous note is still held, both notes will be entered as a chord on the same beat.

STEP RECORD PROCEDURE

1 Select STEP RECORDING Mode



2 Select Length of Step to be Entered



Selected step length (STEP SIZE) is displayed on job chart.

3 Enter Note, Chord or Rest

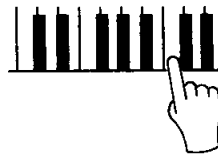

Play note or chord on keyboard, go back to 2 and select the next STEP SIZE, enter next note or chord, and so on.

Press  to enter a rest of the current step size.

The measure count on the digital LED display will be updated as you fill each measure with notes, chords or rests.

4 Tied Notes and Rests



Press to tie the previously entered note or rest to another note or rest.

E.g.: to enter ♩. (this equals ♩)

- a) select step size B-2 (1/4 note).
- b) enter note.
- c) select step size B-1 (1/8 note).
- d) press .

* Notes can only be tied to notes of the same pitch. Rests can only be tied to rests.

5 End Recording and Play Back

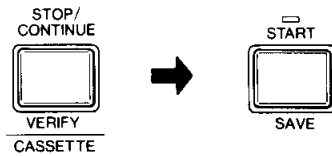

Footswitch STOP/START

A footswitch such as the Yamaha FC4 or FC5 plugged into the rear-panel FOOT SW jack can be used to activate the QX21's record/play START and STOP functions. If the footswitch is pressed while the QX21 is in the normal stop mode, playback will begin. Press the footswitch a second time to stop playback. If the QX21 is in the record standby mode (RECORD indicator ON), however, pressing the footswitch will begin recording. Press the footswitch a second time to stop recording.

SEQUENCING MULTIPLE TONE GENERATORS

Connecting Multiple Tone Generators

With the QX21 it is possible to sequence more than one tone generator at a time—up to a total of 16—by setting different MIDI recording channel numbers for each “part” which is to be played by a different voice. Since the data for all voices is output from the QX21’s single MIDI OUT terminal, the tone generators used must be “daisy-chained” together using their MIDI THROUGH terminals. A practical multi-voice setup using the Yamaha DX11 synthesizer (as recording keyboard and one tone generator) and one or more Yamaha TX81Z FM TONE GENERATOR units is shown in the following system diagram.

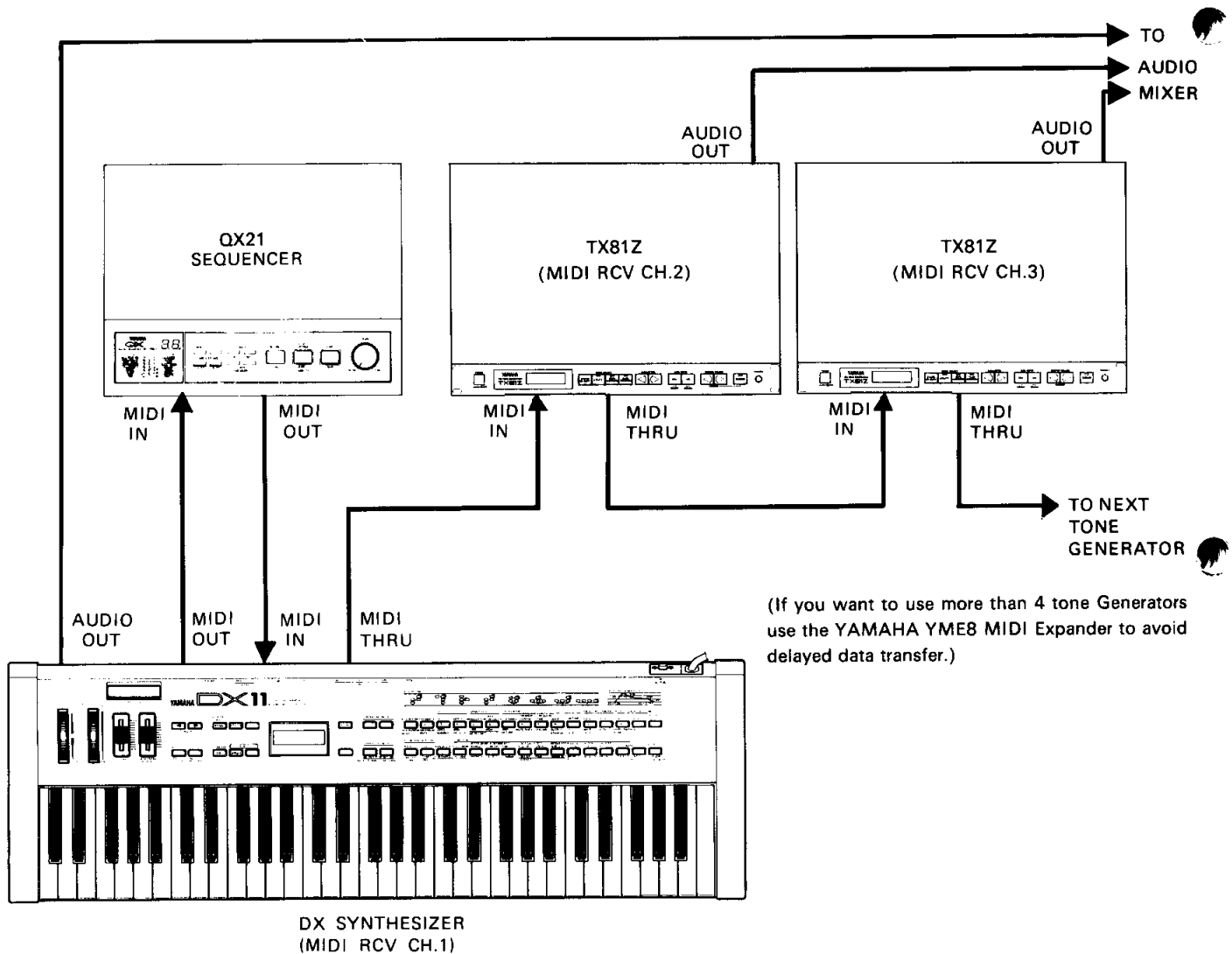

A Multiple Tone Generator System

MIDI Channel Number (Job A-6)

This job sets the MIDI channel number for material recorded in either the real time or step recording modes. The power-on default mode is that the QX21 records on the same channel as the MIDI transmit channel of the recording keyboard. To independently sequence different tone generators, however, the respective parts must be recorded using specific MIDI channel numbers, and the tone generators set to receive only on the corresponding channels. For example, in a simple system using a DX11 and one TZ81Z, when the DX11 receives on channel 1, the TX81Z should be set to receive on channel 2. First you might record a bass line with the QX21 RECORDING MIDI CHANNEL set to 1, and then a piano part with the RECORDING MIDI CHANNEL set to 2. If your DX11 is then set to play a bass voice and the TX81Z a piano voice, the respective parts will be played by the appropriate voices when the QX21 is started.

To set the QX21 RECORDING MIDI CHANNEL, first call job A-6 (you should know how by now). The LED display will alternately read **CH** indicating that the MIDI job is active, and **RL** indicating that the default "ALL CHANNELS" parameter is selected. The -1 and +1 buttons are then used to select the desired MIDI channel number: ALL → 1 → 2 → 3..... → 16. Press RESET to return to job A-1 once the desired MIDI channel has been set.

* Remember that the MIDI channel number set for specific part MUST match the MIDI channel number of the corresponding tone generator.

NOTE:

Multi-timbral synthesizers and tone generators such as the DX11 and TX81Z can act as up to eight independent instruments, each being controlled by a different MIDI channel. This means that you can playback multi-part compositions using just one DX11 or TX81Z. See the owner's manual for your synthesizer or tone generator.

METRONOME/TIMING CONTROL FUNCTIONS

Beat/Measure (Job A-2)

This job makes it possible to set the QX21 to record at different time signatures. The number of metronome beats per measure are adjusted accordingly. Call the BEAT/MEAS job, and the LED display will alternately read \boxed{bt} indicating that the BEAT/MEAS job is active, and the currently selected BEAT/MEAS value. The default is 4 (4/4 time). The -1 and +1 buttons are used to select the desired time signature. The number shown on the LED display indicates the number of beats per bar. A number alone indicates 1/4 notes, and a number with a dot at its lower right-hand corner indicates 1/8 notes. The available values are: 1/4 through 16/4, and 1/8 through 16/8. Press RESET to return to job A-1 once the desired value has been selected.

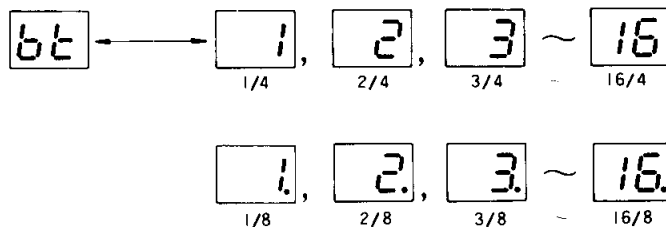

Metronome Mode (Job A-3)

This job makes it possible to set the QX21 metronome to operate during record only (the default value), during record and play, at all times (in case you just need a metronome), or not at all. Call the METRONOME job, and use the -1 and +1 buttons to select the desired mode. The LED display will alternately read \boxed{rn} indicating that the METRONOME job is active, and the currently selected mode. The available modes are:

- \boxed{of} = OFF
- \boxed{rc} = RECORD
- \boxed{rl} = RECORD & PLAY
- \boxed{al} = ALWAYS

Press RESET to return to the job A-1 once the desired mode has been selected.

Clock Select (Job A-5)

Normally, the QX21 is synchronized to its internal clock signal, the speed of which is controlled using the TEMPO control. In some applications, however, the QX21 can be synchronized to an external MIDI clock signal received at the MIDI IN terminal. It might, for example, be useful to synchronize QX21 playback to the clock signal from a MIDI rhythm machine such as the Yamaha RX series Digital Rhythm Programmers. The selection of internal or external clock control is made using the CLOCK job. Call the CLOCK job and the LED display will alternately read \boxed{cs} indicating that the CLOCK job is active, and the currently selected mode.

The desired mode is selected using the -1 and +1 buttons. The modes are:

- \boxed{ic} = INTERNAL CLOCK
- \boxed{ec} = EXTERNAL CLOCK

Press RESET to return to job A-1 once the desired mode has been selected.

NOTE:

1. When the INTERNAL clock mode is selected, note resolution is 1/384 measure. When EXTERNAL is selected, note resolution is 1/96 measure.
2. The QX21 record/playback START and STOP functions can be activated via the QX21's START and STOP buttons, a footswitch connected to the QX21's rear-panel footswitch jack, or by an external MIDI START/STOP signal received at the MIDI IN terminal, whether the QX21 is in the INTERNAL or EXTERNAL clock mode.
3. The QX21 may be made to record under EXTERNAL clock synchronization. With the EXTERNAL clock mode selected and the QX21 set to RECORD, recording will begin immediately when the external clock START signal is received.

Song Position Pointer

The QX21 transmits SONG POSITION POINTER data during playback and recording. This data synchronizes the SONG POSITION (current measure) of an external Yamaha RX21 or RX21L Digital Rhythm Programmer or other MIDI equipment which is capable of receiving SONG POSITION POINTER data to that of the QX21.

For example, QX21 play back or recording can be started from any measure, and the connected Digital Rhythm Programmer will play back from the corresponding measure.

UTILITY FUNCTIONS

All the QX21's utility functions are contained within job lists C and D, which are not listed on the front panel but are given on the QX21 top panel. These jobs are accessed by using the JOB/STEP SIZE selectors in conjunction with the RESET button. For example, to call job C-3, hold the RESET button down while pressing the JOB/STEP SIZE A/C button twice. To call job D-5, hold the RESET button while pressing the JOB/STEP SIZE button 5 times (the first press switches from the A/C list to the first job of the B/D list).

After Touch (Job C-1)

This job determines whether the QX21 receives and records after touch data (MIDI status codes \$An and \$Dn). Call job C-1 by holding RESET and pressing the JOB/STEP SIZE A/C selector 6 times (in order to scroll back to the first job). The LED display will alternately read \overline{AT} indicating that the AFTERTOUC job is active, and the currently selected mode. The -1 and +1 buttons are used to turn the function ON or OFF. The default mode is OFF.

\overline{AT} = After touch data not received.
 \overline{ON} = After touch data receive enabled.

Press RESET to return to Job A-1 after selection.

Control Change & Pitch Bender (Job C-2)

This job determines whether the QX21 receives and records control change and pitch bend data (MIDI status code \$Bn and \$En). Call job C-2 by holding RESET and pressing the JOB/STEP SIZE A/C selector once. The LED display will alternately read \overline{CC} indicating that the CONTROL CHANGE job is active, and the currently selected mode. The -1 and +1 buttons are used to turn the function ON or OFF. The default mode is ON.

\overline{CC} = Control change data not received.
 \overline{ON} = Control change data receive enabled.

Press RESET to return to Job A-1 after selection.

Data with larger control number than 63 will be always received whether this function is ON or OFF.

Key Velocity (Job C-3)

This job determines whether the QX21 receives and records key velocity (initial touch response) data. Call job C-3 by holding RESET and pressing the JOB/STEP SIZE A/C selector twice. The LED display will alternately read \overline{KV} indicating that the KEY VELOCITY job is active, and the currently selected mode. The -1 and +1 buttons are used to turn the function ON or OFF. The default mode is ON.

\overline{KV} = Key velocity data not received.
Key velocity is fixed at \$40
 \overline{ON} = Key velocity data receive enabled.

Press RESET to return to Job A-1 after selection.

Echo Back (Job C-4)

This job determines whether data received at the QX21 MIDI IN terminal is to be output ("echoed") as received via the MIDI OUT terminal. Call job C-4 by holding RESET and pressing the JOB/STEP SIZE A/C selector 3 times. The LED display will alternately read \overline{EB} indicating that the ECHO BACK job is active, and the currently selected mode. The -1 and +1 buttons are used to turn the function ON or OFF. The default mode is OFF.

- $\overline{0F}$ = Echo disabled.
- $\overline{0n}$ = Echo enabled.

Press RESET to return to Job A-1 after selection.

This function should be turned ON when the QX21 is used in a system in which the recording keyboard has no internal tone generation system—such as the Yamaha KX5 or KX76/88 keyboards—and the output of the QX21 is driving a separate tone generator such as the TX81Z. This enables the keyboard to “play” the tone generator directly via the QX21 as shown in the following diagram.

KX5 → QX21 → TX7 SYSTEM DIAGRAM

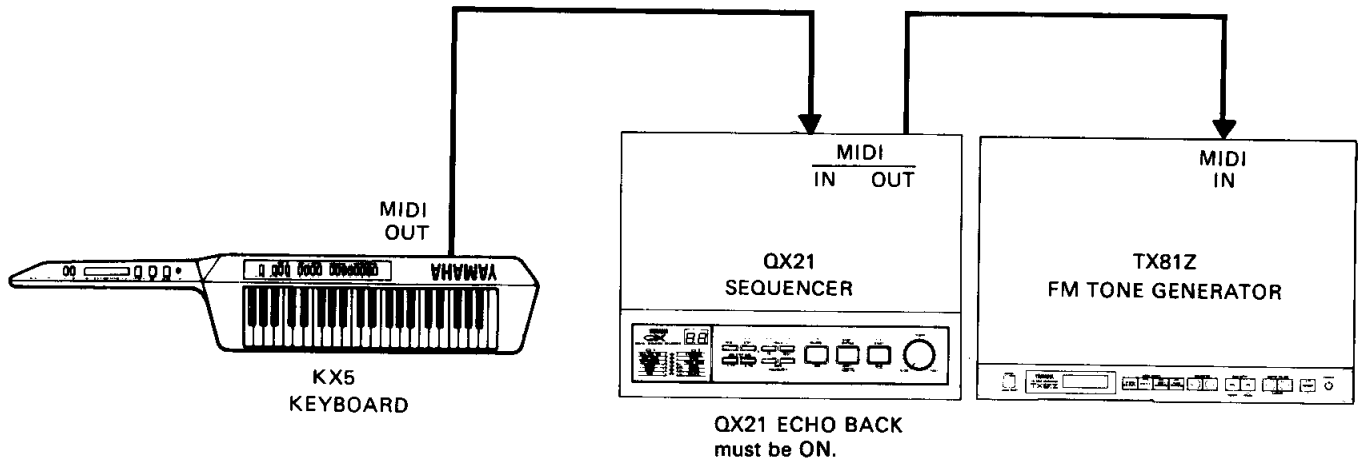

Protect (Job C-5)

When ON, this job prevents alteration of data residing in the QX21 memory (tracks 1 and 2, and the temporary buffer). The default mode is OFF. Call job C-5 by holding the RESET button while pressing the JOB/STEP SIZE A/C selector 4 times. The LED display will alternately read $\overline{0r}$ indicating that the MEMORY PROTECT job is active, and the currently selected mode. The -1 and +1 buttons turn MEMORY PROTECT OFF and ON.

- $\overline{0n}$ = Memory protect ON.
- $\overline{0F}$ = Memory protect OFF.

Press RESET to return to job A-1 after selection. If you attempt to RECORD, TRACK DOWN, CHAIN, EXCHANGE, ERASE, or perform any other memory-altering function while MEMORY PROTECT is ON, the QX21 will respond with $\overline{0r}$ (“memory protected” display) and issue a warning “beep”.

Display MIDI status (Job C-6)

Activating this job forces the QX21 to function as a MIDI status monitor rather than a sequencer. In other words, MIDI data received at the MIDI IN terminal will be displayed in hexadecimal form on the QX21’s LED display. This function is particularly handy for monitoring MIDI signal status in a MIDI music system, troubleshooting, MIDI system research, etc. The default mode for this job is OFF.

Call job C-6 by holding the RESET button while pressing the JOB/STEP SIZE A/C selector 5 times. The LED display will alternately read $\overline{05}$ indicating that the DISPLAY MIDI STATUS job has been called, and the currently selected mode. Use the -1 and +1 buttons to turn the function OFF and ON.

- $\overline{0F}$ = Normal QX21 operation.
- $\overline{0n}$ = MIDI status monitor operation.

If ON is selected, press the RESET button to clear the LED display and begin operation as a MIDI status monitor. Job C-6 must be recalled and set to OFF to resume normal QX21 operation. If OFF is selected, pressing RESET returns to job A-1.

Save Temporary Buffer (Job D-1)

As we discovered in the Quantize section, above, the QX21 has a temporary buffer memory. Executing this job swaps the contents of TRACK 1 and the temporary buffer, recalling the temporary buffer data into TRACK 1, and saving the TRACK 1 data in the temporary buffer. In addition to allowing you to recall the original data after a quantize operation, the temporary buffer is also useful in a number of editing situations. Suppose, for example, that you have a phrase which will occur more than once during the course of a composition. This phrase can be created and saved in the temporary buffer using the SAVE TEMPORARY BUFFER job. It can then be recalled and chained onto or inserted into the data on TRACK 2 as needed. Call job D-1 by holding the RESET button and pressing the JOB/STEP SIZE B/D selector once. The LED display will read $\boxed{5t}$ and the TRACK 1 indicator will flash. Pressing the START button then actually executes the SAVE TEMPORARY BUFFER job, or RESET to cancel.

Delete Channel (Job D-2)

This job makes it possible to delete a single MIDI channel from a multi-channel recording (refer to "SEQUENCING MULTIPLE TONE GENERATORS" section). Since material recorded on other MIDI channels is left intact, this function eliminates the need to redo an entire recording if only one channel is not satisfactory.

Call job D-2 by holding the RESET button and pressing the JOB/STEP SIZE B/D selector twice. The LED display will read \boxed{dc} . Then use the -1 and +1 buttons to select the number of the MIDI channel to be deleted (1 ~ 16). Finally, press the START button to delete the selected channel.

Quantize (Job D-3)

With this job it is possible to correct "off-time" notes entered in the real time record mode by forcing all notes to fall on the nearest "quantize" unit. The available quantize values are: 1/4, 1/6, 1/8, 1/12, 1/16 and 1/24 notes.

For example, if a phrase in which the smallest note length is 1/8 notes has been entered in the real time record mode, and some of the notes are a little off-time—i.e. the notes do not fall precisely on 1/8th measure increments—the phrase can be quantized to 1/8 causing all the notes to fall into perfect time.

The QUANTIZE job can be used only on data which is on TRACK 1. First, call job D-3 by holding the RESET button and pressing the JOB/STEP SIZE B/D selector 3 times. The LED display will alternately read \boxed{qt} indicating that the QUANTIZE job is active, and the currently selected value. Use the -1 and +1 buttons to select the desired value. Pressing the START button then actually executes the QUANTIZE job, or RESET to cancel. The quantized data is left on TRACK 1. To give you a second chance just in case quantizing ruins your recording, the data is stored in the QX21's temporary buffer memory prior to quantizing. The data in the temporary buffer can be recalled to TRACK 1 using the SAVE TEMPORARY BUFFER job (job D-1) described above.

NOTE:

The selected quantize value must be equal to or smaller than the smallest note length contained in the data to be quantized, otherwise random omission of notes or changes in note length may occur (thus the temporary buffer save operation!).

Cassette Save/ Verify/Load (Job D-4)

This job incorporates the cassette save, verify and load functions which permit you to save your QX21 compositions on standard cassette tape and load them whenever they are needed. To use the cassette interface, make sure that the cassette cable is properly connected to the QX21's CASSETTE DIN connector and the cassette recorder's earphone and microphone connectors (see page 4).

To perform any cassette operation, it is first necessary to call the CASSETTE TAPE job. Call job D-4 by holding the RESET button and pressing the JOB/STEP SIZE B/D selector 4 times. The LED display will read $\boxed{C-P}$ indicating that the CASSETTE TAPE job is active. Any of the three available cassette functions—LOAD, VERIFY and SAVE—are then activated by pressing the corresponding button: RECORD/LOAD, STOP/CONTINUE/VERIFY or START/SAVE. The three functions will be covered separately below.

SAVE

This function saves the contents of the QX21 memory to cassette tape. First call the CASSETTE TAPE job, start the cassette recorder running in the record mode, then press the SAVE button. The LED display will read $\boxed{S-}$ indicating that the SAVE operation is being performed. The QX21 will beep once for each data block (256 bytes) which is saved. When the data has been saved the QX21 will automatically revert to job A-1.

VERIFY

This function reads the data on the cassette tape and compares it to the data in the QX21 memory, "verifying" that the preceding SAVE operation was accomplished with no data errors. The VERIFY function should always be used to ensure the integrity of your saved data. First, rewind the cassette tape to the beginning of the file to be verified (the file you just saved). Call the CASSETTE TAPE job, start the cassette recorder running in the play mode, then press the VERIFY button. The LED display will read \boxed{V} while the QX21 is searching for the beginning of the file, $\boxed{V-}$ to indicate that it is reading the file, and finally either $\boxed{O-U}$ if the data is OK, or $\boxed{N-U}$ if the cassette data does not match the QX21 memory data. The QX21 will beep once for each data block (256 bytes) which is received. If an error is encountered, try saving the memory contents again.

LOAD

This function lets you load a previously SAVED file back into the QX21 memory from a cassette tape. First, rewind the cassette tape to the beginning of the file to be loaded, call the CASSETTE TAPE job, and press the LOAD button. The LED display will read \boxed{L} while the QX21 is searching for the beginning of the file, $\boxed{L-}$ to indicate that it is loading the file, and when the file has been loaded the QX21 will show $\boxed{O-U}$. The QX21 will beep once for each data block (256 bytes) which is received.

NOTE:

1. If a data error is encountered during Verify or Load, the QX21 will sound alternate high and low beeps.
2. Yamaha QX7 Digital Sequence Recorder cassette tape data is fully compatible with the QX21, and may be loaded and used with the QX21 as described above.

**Local Device
Number
(Job D-5)**

This job specifies the MIDI channel to be used by the QX21 for MIDI SYSTEM EXCLUSIVE DATA communication, and permits dumping all QX21 track memory data via the MIDI OUT terminal. Call job D-5 by holding the RESET button while pressing the JOB/STEP SIZE B/D selector 5 times. The LED display will alternately read $\boxed{L n}$ indicating that the LOCAL DEVICE NUMBER job is active, and the currently selected channel number (normally 1). Use the -1 and +1 buttons to select the desired MIDI channel number (1 through 16). Press the START button while in this mode to initiate a bulk dump of the data contained in the currently selected track. The LED display will read $\boxed{d 1}$ while track 1 is being dumped, and $\boxed{d 2}$ while track 2 is being dumped. Press RESET to return to job A-1.

NOTE:

Since QX7 Digital Sequence Recorder data is fully compatible with the QX21, QX7 data may be directly dumped onto the QX21, and vice versa.

**Show Free Area
(Job D-6)**

This job provides an indication of how much free memory space is available for further recording.

Call job D-6 by holding the RESET button and pressing the JOB/STEP SIZE B/D selector 6 times. The LED display will alternately read $\boxed{F r}$ and the remaining memory space as a number between 0 and 99. "99" indicates that nothing has been recorded and the entire QX21 memory is available. The smaller the number the less memory space remains. "0" indicates that the memory is full.

ERROR MESSAGES

The QX21 has a number of error messages it will flash at you (along with a warning "beep") should something go wrong. They are as followings:

Pr MEMORY PROTECT

You have attempted to enter or change data while the memory protect function is ON.

FL MEMORY FULL

The QX21 memory is full and can accept no more data.

nF NEAR FULL

Indicates that remaining memory capacity is less than "1" (see Job D-6) during recording.

E1 RECORD DATA ERROR

The QX21 has received record data it does not know how to deal with (illegal record data).

E2 ILLEGAL COMMAND

You have attempted to execute a job incorrectly.

E3 MIDI HARDWARE ERROR

This message indicates a hardware problem such as ACIA overrun, framing error, etc.

E4 MIDI DATA ERROR

Indicates that a checksum error has been encountered in MIDI reception.

E5 MEMORY VOLATILE ERROR

Indicates that the memory backup system has failed.

SPECIFICATIONS

Memory Capacity	8,100 notes (approx.) without velocity
	6,000 notes (approx.) with velocity
Tempo Control	♩ = 40 ~ 250
Display	7 segment LED x 2
Connection Terminals	MIDI IN, MIDI OUT, MIDI THRU, CASSETTE, FOOT Switch
Power Requirements	U.S. and Canadian Models: AC120V 50/60 Hz
	General Model: AC220-240V
Power Consumption	U.S. and Canadian Models: 10W
	General Model: 10W
Dimensions (W x H X D)	351 x 50 x 241 mm (13-5/6" x 2" x 9-1/2")
Weight.....	2.3 kg (5 lbs. 1 oz.)

* All specifications are subject to change without notice.

MIDI DATA FORMAT

1. RECEPTION CONDITIONS

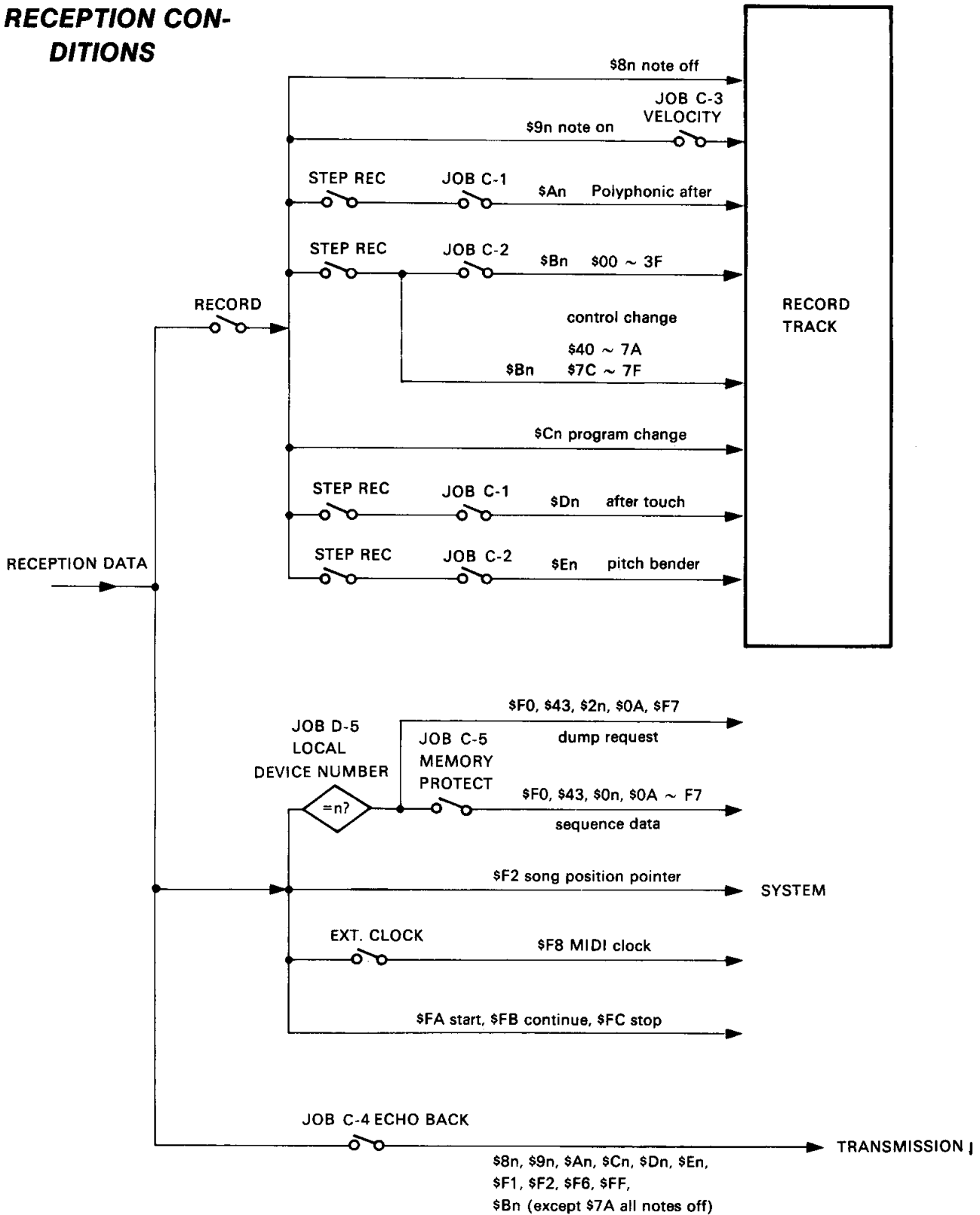

2. RECEPTION DATA

2-1 Reception Channel

Using the QX21 RECORDING MIDI CHANNEL JOB (A-6) the received MIDI number can be recorded as is, or a specific MIDI channel number may be assigned.

2-2 Channel Voice Message

2-2-1 Key Off

Status	1000nnnn	n = channel no.
Note no.	0kkkkkkk	k = 1 (C#-2) ~ 127 (G8)
Velocity	0vvvvvvvv	v = ignored

2-2-2 Key On/Off

Status	1001nnnn	n = channel no.
Note no.	0kkkkkkk	k = 1 (C#-2) ~ 127 (G8)
Velocity	0vvvvvvvv	v = 0 key off v = 1 ~ 127 key on

The received velocity data is recorded, or the preset medium value 64 is recorded according to the setting of KEY VELOCITY JOB C-3.

2-2-3 Polyphonic Aftertouch

Status	1010nnnn	n = channel no.
Note no.	0kkkkkkk	k = 1 (C#-2) ~ 127 (G8)
Pressure	0vvvvvvvv	

Recorded during real-time record when AFTER TOUCH JOB C-3 is ON.

2-2-4 Control Change

Status	1011nnnn	
Control no.	0ccccccc	
Control value	0vvvvvvvv	

Control numbers 0 through 63 recorded during real-time record when CONTROL CHANGE JOB C-2 is ON. Control numbers 64 through 121 are recorded whether CONTROL CHANGE JOB C-2 is ON or OFF.

2-2-5 Program Change

Status	1100nnnn	
Program no.	0pppppppp	

2-2-6 After touch

Status	1101nnnn	
Pressure	0vvvvvvvv	

Recorded during real-time record when AFTER TOUCH JOB C-1 is ON.

2-2-7 Pitch Bend

Status	1110nnnn	
Value (LSB)	0uuuuuuuu	
Value (MSB)	0vvvvvvvv	

Recorded during real-time record when CONTROL CHANGE & BENDER JOB C-2 is ON.

2-3 Channel Mode Message

Status	1011nnnn	
	0ccccccc	
	0vvvvvvvv	
c = 124, v = 0:	OMNI MODE OFF	
c = 125, v = 0:	OMNI MODE ON	
c = 126, v = 1:	MONO MODE ON	
c = 127, v = 0:	POLY MODE ON	

Recorded during real-time record.

2-4 System Exclusive Message

2-4-1 Dump Request

Status	11110000	
ID	01000011	
Substatus/ch	0010nnnn	n = LOCAL DEVICE NO.
Format no.	00001010	

Recorded when the LOCAL DEVICE NUMBER JOB D-5 matches "n". When matched the sequence data is dumped via MIDI OUT.

Not recorded during playback, recording, or cassette save and load operations.

2-4-2 Sequence Data

Status	11110000	
ID	01000011	
Substatus/ch	0000nnnn	n = LOCAL DEVICE NO.
Format no.	00001010	
Byte count	0bbbbbbb	
Byte count	0bbbbbbb	
Data	01001100	'L
	01001101	'M
	00100000	space
	00100000	space
	01001110	'N
	01010011	'S
	01000101	'E
	01010001	'Q
	00000000	space
	00000000	space
	0ddddddd	
	?	
	0ddddddd	
Checksum	0sssssss	

} Header

} Sequence data (ASCII)

* If the byte count exceeds 4096, then the data is separated into 4096 byte blocks, each with a byte count at the beginning (LMuuNSEQuu) and a checksum at the end.

* When multiple track data is sent, the data for each track is sent separately even if the data does not exceed 4096 bytes.

Reception is possible when the LOCAL DEVICE NUMBER JOB D-5 matches "n", and PROTECT JOB C-5 is OFF.

2-5 System Common Message

2-5-1 Song Position Pointer

Status	11110010
Value (LSB)	0LLLLLLL
Value (MSB)	0hhhhhhh

2-6 System Realtime Message

2-6-1 Timing Clock

Status	11111000
--------	----------

Received when CLOCK SELECT JOB A-5 is set to EXTERNAL.

2-6-2 Start

Status	11111010
--------	----------

2-6-3 Continue/Start

Status	11111011
--------	----------

2-6-4 Stop

Status	11111100
--------	----------

3. TRANSMISSION CONDITIONS

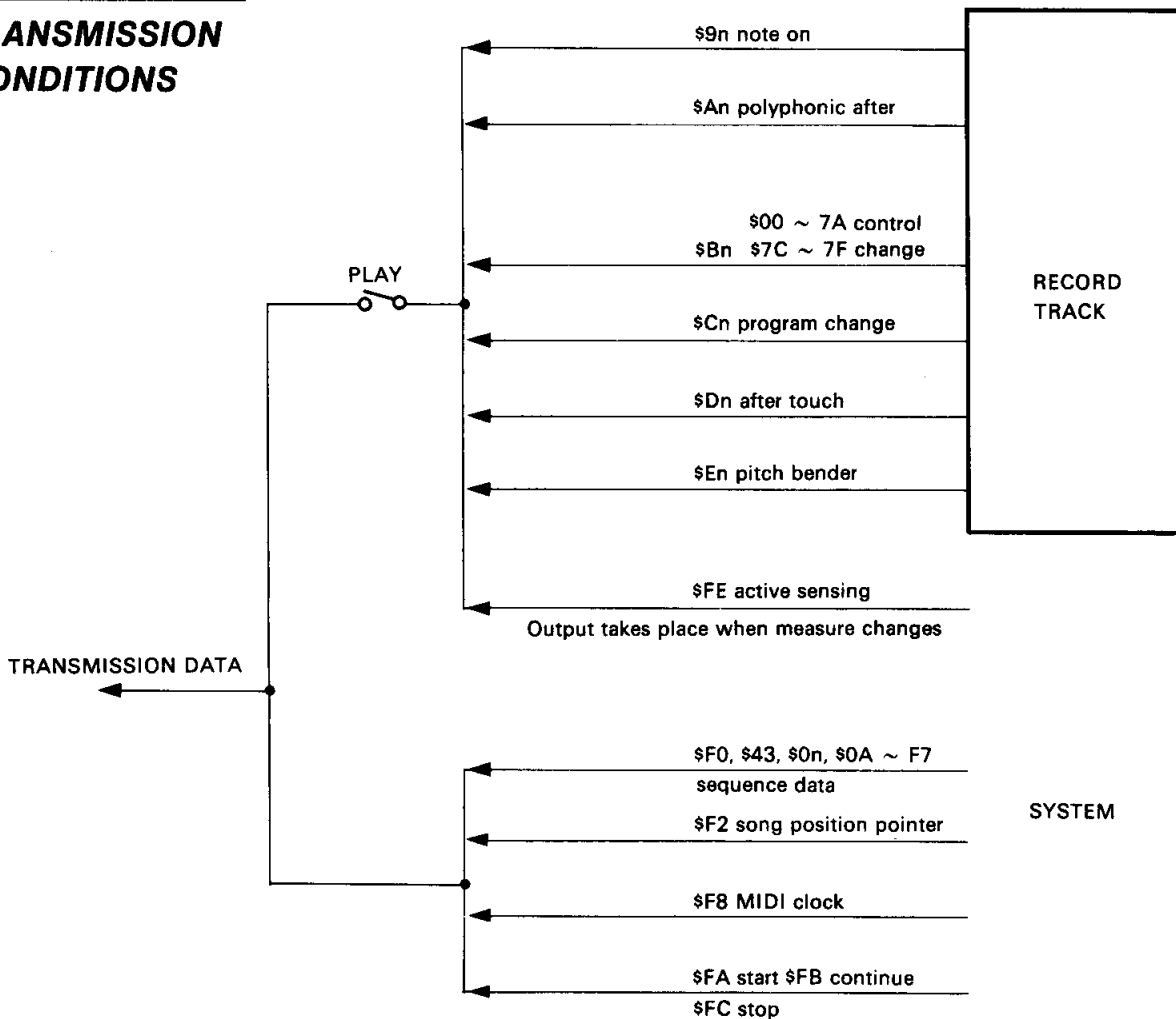

4. TRANSMISSION DATA

The sequence data recorded in the QX21 is transmitted when a PLAY operation is initiated. Active sensing is also transmitted during the PLAY mode.

4-1 Channel Voice Message

The following recorded data is transmitted during a PLAY operation.

1. Key ON/OFF (Status 1001nnnn, n = recorded channel no.)
2. Polyphonic after touch
3. Control change
4. Program change
5. After touch
6. Pitch bend

4-2 Channel Mode Message

The following recorded data is transmitted during a PLAY operation.

OMNI MODE OFF
OMNI MODE ON
MONO MODE ON
POLY MODE ON

4-3 System Exclusive Message

4-3-1 Sequence Data

The same data which has been received is dumped from the selected track if the START button is pressed while the LOCAL DEVICE NUMBER JOB D-5 is active.

4-4 System Common Message

4-4-1 Song Position Pointer

Status	11110010
Value (LSB)	0LLLLLLL
Value (MSB)	0hhhhhhh

4-5 System Realtime Message

4-5-1 Timing Clock

Status	11111000
--------	----------

Transmitted at all times, except when CASSETTE JOB D-4 is active or when CLOCK SELECT JOB A-5 is set to EXTERNAL.

4-5-2 Start

Status	11111010
--------	----------

Transmitted when the START button is pressed.

4-5-3 Continue/Start

Status	11111011
--------	----------

Transmitted when the CONTINUE button is pressed in the play stop mode.

4-5-4 Stop

Status 11111100

Transmitted when the STOP button is pressed during the play mode.

4-5-5 Active Sensing

Status 11111110

Transmitted at each measure break during playback.

— MEMO —

Function ...	Transmitted	Recognized	Remarks
Basic Default Channel Changed	all channel x	all channel x	not Basic Ch.
Mode Default Messages	POLY, MONO OMNIon, OMNIoff	POLY, MONO OMNIon, OMNIoff	
Note Number : True voice	1 - 111 XXXXXXXXXXXXXXXXXX	1 - 127 1 - 111	
Velocity Note ON Note OFF	o 9nH V=1-127 x 9nH V=0	o X x	X key velocity ON
After Touch Key's Ch's	o o	o X o X	X after touch ON X after touch ON
Pitch Bender	o	o X	X ctrl change ON
Control Change 0 - 63 64 - 122 124 - 127	o o o	o X o o	X control change ON
Prog Change : True #	0 - 127 XXXXXXXXXXXXXXXXXX	0 - 127	
System Exclusive	o	o	sequence data
System Common : Song Pos Song Sel Tune	o o XXX o	o o XXX o	
System Real Time : Clock Commands	o o	o XX o	XX ext. clock select
Aux Messages : Local ON/OFF All Notes OFF Active Sense Reset	o x o o XXX	o x x o XXX	
Notes	XXX These messages are not recognized by QX7, only bypassed to MIDI OUT in ECHO BACK ON mode. Other all messages except System Exclusive and Real Time are bypassed in ECHO BACK ON mode.		
Mode 1 : OMNI ON, POLY Mode 3 : OMNI OFF, POLY	Mode 2 : OMNI ON, MONO Mode 4 : OMNI OFF, MONO	o : Yes x : No	

IMPORTANT SAFETY AND INSTALLATION INSTRUCTIONS

INFORMATION RELATING TO POSSIBLE PERSONAL INJURY, ELECTRIC SHOCK AND FIRE HAZARD POSSIBILITIES HAS BEEN INCLUDED IN THIS LIST.

WARNING — When using electronic products, basic precautions should always be followed, including the following:

1. Read all Safety and Installation Instructions, Supplemental Marking and Special Message Section data, and any applicable assembly instructions BEFORE using this product.
2. Check unit weight specifications BEFORE you attempt to move this product.
3. Main power supply verification. Yamaha Digital Musical Instrument products are manufactured specifically for use with the main supply voltage used in the area where they are to be sold. The main supply voltage required by these products is printed on the name plate. For name plate location please refer to the graphic in the Special Message section. If any doubt exists please contact the nearest Yamaha Digital Musical Instrument retailer.
4. Some Yamaha Digital Musical Instrument products utilize external power supplies or adapters. Do NOT connect products of this type to any power supply or adapter other than the type described in the owners manual or as marked on the unit.
5. This product may be equipped with a plug having three prongs or a polarized line plug (one blade wider than the other). If you are unable to insert the plug into the outlet, contact an electrician to have the obsolete outlet replaced. Do NOT defeat the safety purpose of the plug. Yamaha products not having three prong or polarized line plugs incorporate construction methods and designs that do not require line plug polarization.
6. **WARNING** — Do NOT place objects on the power cord or place the unit in a position where any one could walk on, trip over, or roll anything over cords of any kind. An improper installation of this type can create the possibility of a fire hazard and/or personal injury.
7. Environment: Your Yamaha Digital Musical Instrument should be installed away from heat sources such as heat registers and/or other products that produce heat.
8. Ventilation: This product should be installed or positioned in a way that its placement or location does not interfere with proper ventilation.
9. Yamaha Digital Musical Instrument products are frequently incorporated into "Systems" which are assembled on carts, stands or in racks. Utilize only those carts, stands, or racks that have been designed for this purpose and observe all safety precautions supplied with the products. Pay special attention to cautions that relate to proper assembly, heavier units being mounted at the lower levels, load limits, moving instructions, maximum usable height and ventilation.
10. Yamaha Digital Musical Instrument products, either alone or in combination with amplification, headphones, or speakers, may be capable of producing sound levels that could cause permanent hearing loss. Do NOT operate at high volume levels or at a level that is uncomfortable. If you experience any discomfort, ringing in the ears, or suspect any hearing loss, you should consult an audiologist.
11. Do NOT use this product near water or in wet environments. For example, near a swimming pool, spa, in the rain, or in a wet basement.
12. Care should be taken so that objects do not fall, and liquids are not spilled into the enclosure.
13. Yamaha Digital Musical Instrument products should be serviced by a qualified service person when:
 - a. The power supply/power adapter cord or plug has been damaged; or
 - b. Objects have fallen, or liquid has been spilled into the products; or
 - c. The unit has been exposed to rain; or
 - d. The product does not operate, exhibits a marked change in performance; or
 - e. The product has been dropped, or the enclosure of the product has been damaged.
14. When not in use, always turn your Yamaha Digital Musical Instrument equipment "OFF". The power supply cord should be unplugged from the outlet when the equipment is to be left unused for a long period of time. NOTE: In this case, some units may lose some user programmed data. Factory programmed memories will not be affected.
15. Electromagnetic Interference (RFI). Yamaha Digital Musical Instruments utilize digital (high frequency pulse) technology that may adversely affect Radio/TV reception. Please read FCC Information (back cover) for additional information.
16. Do NOT attempt to service this product beyond that described in the user maintenance section of the owners manual. All other servicing should be referred to qualified service personnel.

**PLEASE KEEP THIS MANUAL
FOR FUTURE REFERENCE!**

FCC INFORMATION

While the following statements are provided to comply with FCC Regulations in the United States, the corrective measures listed below are applicable worldwide.

This series of Yamaha professional music equipment uses frequencies that appear in the radio frequency range and if installed in the immediate proximity of some types of audio or video devices (within three meters), interference may occur. This series of Yamaha combo equipment have been type tested and found to comply with the specifications set for a class B computing device in accordance with those specifications listed in subpart J of part 15 of the FCC rules. These rules are designed to provide a reasonable measure of protection against such interference. However, this does not guarantee that interference will not occur. If your professional music equipment should be suspected of causing interference with other electronic devices, verification can be made by turning your combo equipment off and on. If the interference continues when your equipment is off, the equipment is not the source of interference. If your equipment does appear to be the source of the interference, you should try to correct the situation by using one or more of the following measures:

Relocate either the equipment or the electronic device that is being affected by the interference. Utilize power outlets for the professional music equipment and the device being affected that are on different branch (circuit breaker or fuse) circuits, or install AC line filters.

In the case of radio or TV interference, relocate the antenna or, if the antenna lead-in is 300 ohm ribbon lead, change the lead-in to co-axial type cable.

If these corrective measures do not produce satisfactory results, please contact your authorized Yamaha professional products dealer for suggestions and/or corrective measures.

If you cannot locate a franchised Yamaha professional products dealer in your general area contact the professional products Service Department, Yamaha Music Corporation, 6600 Orangethorpe Ave., Buena Park, CA 90620, U.S.A.

If for any reason, you should need additional information relating to radio or TV interference, you may find a booklet prepared by the Federal Communications Commission helpful:

"How to Identify and Resolve Radio — TV Interference Problems". This booklet is available from the U.S. Government Printing Office, Washington D.C. 20402 — Stock No. 004-000-00345-4.

YAMAHA

YAMAHA CORPORATION
P.O. Box 1, Hamamatsu, Japan

VD68650 88 03 0.5 R2 CR Printed in Japan